

R&S® FSV-K91/91n/91ac/91p WLAN TX Measurements Operating Manual



1176.7649.02 – 04

This manual describes the following R&S®FSV options:

- R&S FSV-K91 (1310.8903.02)
- R&S FSV-K91n (1310.9468.02)
- R&S FSV-K91ac (1310.8926.02)
- R&S FSV-K91p (1321.3314.02)

This manual describes the following R&S®FSV models with firmware version 2.30 and higher:

- R&S®FSV 4 (1321.3008K04)
- R&S®FSV 7 (1321.3008K07)
- R&S®FSV 13 (1321.3008K13)
- R&S®FSV 30 (1321.3008K30)
- R&S®FSV 40 (1321.3008K39)
- R&S®FSV 40 (1321.3008K40)

It also applies to the following R&S®FSV models. However, note the differences described in [chapter 1.4, "Notes for Users of R&S FSV 1307.9002Kxx Models"](#), on page 9.

- R&S®FSV 3 (1307.9002K03)
- R&S®FSV 7 (1307.9002K07)
- R&S®FSV 13 (1307.9002K13)
- R&S®FSV 30 (1307.9002K30)
- R&S®FSV 40 (1307.9002K40)

The firmware of the instrument makes use of several valuable open source software packages. For information, see the "Open Source Acknowledgement" on the user documentation CD-ROM (included in delivery).

Rohde & Schwarz would like to thank the open source community for their valuable contribution to embedded computing.

© 2014 Rohde & Schwarz GmbH & Co. KG
Mühldorfstr. 15, 81671 München, Germany
Phone: +49 89 41 29 - 0
Fax: +49 89 41 29 12 164
E-mail: info@rohde-schwarz.com
Internet: www.rohde-schwarz.com

Subject to change – Data without tolerance limits is not binding.

R&S® is a registered trademark of Rohde & Schwarz GmbH & Co. KG.

Trade names are trademarks of the owners.

The following abbreviations are used throughout this manual: R&S®FSV is abbreviated as R&S FSV.

Contents

1	Preface	5
1.1	Documentation Overview.....	5
1.2	Conventions Used in the Documentation.....	7
1.3	How to Use the Help System.....	8
1.4	Notes for Users of R&S FSV 1307.9002Kxx Models.....	9
2	Introduction	10
3	WLAN TX Measurements	11
3.1	Introduction to WLAN 802.11A, AC, B, G, J, N & P TX Tests.....	12
3.2	Basic Measurement Examples.....	13
3.3	Signal Processing of the IEEE 802.11a Application.....	21
3.4	Signal Processing of the IEEE 802.11b Application.....	29
3.5	802.11b RF Carrier Suppression.....	35
3.6	IEEE 802.11n/ac MIMO Measurements.....	36
3.7	Signal Field Measurement (IEEE 802.11ac, n (SISO+MIMO)).....	39
3.8	Measurement Result Types.....	43
3.9	Measurement Settings and Result Displays.....	50
4	Instrument Functions WLAN TX Measurements	62
4.1	Softkeys of the WLAN TX Menu.....	63
4.2	General Settings Dialog Box (K91).....	87
4.3	Demod Settings Dialog Box.....	97
4.4	Softkeys of the Sweep Menu – SWEEP key	110
4.5	Softkeys of the Trace Menu – TRAC key.....	111
4.6	Softkeys of the Marker Menu – MKR key (WLAN).....	111
4.7	Softkeys of the Marker To Menu – MKR-> key.....	112
4.8	Softkeys of the Lines Menu – LINES key.....	113
4.9	Softkeys of the Input/Output Menu for WLAN Measurements.....	113
5	Remote Commands for WLAN TX Measurements	116
5.1	Notation.....	117
5.2	ABORt Subsystem.....	120
5.3	CALCulate:BURSt Subsystem (WLAN).....	120

5.4	CALCulate:LIMit Subsystem (WLAN).....	121
5.5	CALCulate:MARKer Subsystem (WLAN).....	138
5.6	CONFigure Subsystem (WLAN).....	145
5.7	DISPlay Subsystem (WLAN).....	163
5.8	FETCh Subsystem (WLAN).....	168
5.9	FORMat Subsystem.....	176
5.10	INITiate Subsystem.....	176
5.11	INPut Subsystem.....	177
5.12	INSTRument Subsystem (WLAN).....	179
5.13	MMEMory Subsystem (WLAN).....	179
5.14	SENSe Subsystem (WLAN).....	181
5.15	STATus Subsystem (WLAN).....	204
5.16	TRACe Subsystem (WLAN).....	208
5.17	TRIGger Subsystem (WLAN).....	217
5.18	UNIT Subsystem (K91).....	220
5.19	Status Reporting System (Option R&S FSV-K91).....	221
	List of Commands.....	228
	Index.....	234

1 Preface

1.1 Documentation Overview

The user documentation for the R&S FSV is divided as follows:

- Quick Start Guide
- Operating Manuals for base unit and options
- Service Manual
- Online Help
- Release Notes

Quick Start Guide

This manual is delivered with the instrument in printed form and in PDF format on the CD. It provides the information needed to set up and start working with the instrument. Basic operations and basic measurements are described. Also a brief introduction to remote control is given. The manual includes general information (e.g. Safety Instructions) and the following chapters:

Chapter 1	Introduction, General information
Chapter 2	Front and Rear Panel
Chapter 3	Preparing for Use
Chapter 4	Firmware Update and Installation of Firmware Options
Chapter 5	Basic Operations
Chapter 6	Basic Measurement Examples
Chapter 7	Brief Introduction to Remote Control
Appendix	LAN Interface

Operating Manuals

The Operating Manuals are a supplement to the Quick Start Guide. Operating Manuals are provided for the base unit and each additional (software) option.

The Operating Manual for the base unit provides basic information on operating the R&S FSV in general, and the "Spectrum" mode in particular. Furthermore, the software options that enhance the basic functionality for various measurement modes are described here. The set of measurement examples in the Quick Start Guide is expanded by more advanced measurement examples. In addition to the brief introduction to remote control in the Quick Start Guide, a description of the basic analyzer commands and programming examples is given. Information on maintenance, instrument interfaces and error messages is also provided.

In the individual option manuals, the specific instrument functions of the option are described in detail. For additional information on default settings and parameters, refer

to the data sheets. Basic information on operating the R&S FSV is not included in the option manuals.

The following Operating Manuals are available for the R&S FSV:

- R&S FSV base unit; in addition:
 - R&S FSV-K9 Power Sensor Support
 - R&S FSV-K14 Spectrogram Measurement
- R&S FSV-K7 Analog Demodulation and R&S FSV-K7S FM Stereo Measurements
- R&S FSV-K10 GSM/EDGE Measurement
- R&S FSV-K30 Noise Figure Measurement
- R&S FSV-K40 Phase Noise Measurement
- R&S FSV-K70 Vector Signal Analysis Operating Manual
R&S FSV-K70 Vector Signal Analysis Getting Started (First measurements)
- R&S FSV-K72 3GPP FDD BTS Analysis
- R&S FSV-K73 3GPP FDD UE Analysis
- R&S FSV-K76/77 3GPP TD-SCDMA BTS/UE Measurement
- R&S FSV-K82/83 CDMA2000 BTS/MS Analysis
- R&S FSV-K84/85 1xEV-DO BTS/MS Analysis
- R&S FSV-K91 WLAN IEEE 802.11
- R&S FSV-K93 WiMAX IEEE 802.16 OFDM/OFDMA Analysis
- R&S FSV-K100/K104 EUTRA / LTE Downlink Measurement Application
- R&S FSV-K101/K105 EUTRA / LTE Uplink Measurement Application

These manuals are available in PDF format on the CD delivered with the instrument.

Service Manual

This manual is available in PDF format on the CD delivered with the instrument. It describes how to check compliance with rated specifications, instrument function, repair, troubleshooting and fault elimination. It contains all information required for repairing the R&S FSV by replacing modules. The manual includes the following chapters:

Chapter 1	Performance Test
Chapter 2	Adjustment
Chapter 3	Repair
Chapter 4	Software Update / Installing Options
Chapter 5	Documents

Online Help

The online help contains context-specific help on operating the R&S FSV and all available options. It describes both manual and remote operation. The online help is installed on the R&S FSV by default, and is also available as an executable .chm file on the CD delivered with the instrument.

Release Notes

The release notes describe the installation of the firmware, new and modified functions, eliminated problems, and last minute changes to the documentation. The corresponding firmware version is indicated on the title page of the release notes. The current release notes are provided in the Internet.

1.2 Conventions Used in the Documentation

1.2.1 Typographical Conventions

The following text markers are used throughout this documentation:

Convention	Description
"Graphical user interface elements"	All names of graphical user interface elements on the screen, such as dialog boxes, menus, options, buttons, and softkeys are enclosed by quotation marks.
KEYS	Key names are written in capital letters.
File names, commands, program code	File names, commands, coding samples and screen output are distinguished by their font.
<i>Input</i>	Input to be entered by the user is displayed in italics.
Links	Links that you can click are displayed in blue font.
"References"	References to other parts of the documentation are enclosed by quotation marks.

1.2.2 Conventions for Procedure Descriptions

When describing how to operate the instrument, several alternative methods may be available to perform the same task. In this case, the procedure using the touchscreen is described. Any elements that can be activated by touching can also be clicked using an additionally connected mouse. The alternative procedure using the keys on the instrument or the on-screen keyboard is only described if it deviates from the standard operating procedures.

The term "select" may refer to any of the described methods, i.e. using a finger on the touchscreen, a mouse pointer in the display, or a key on the instrument or on a keyboard.

1.3 How to Use the Help System

Calling context-sensitive and general help

- ▶ To display the general help dialog box, press the HELP key on the front panel.
The help dialog box "View" tab is displayed. A topic containing information about the current menu or the currently opened dialog box and its function is displayed.



For standard Windows dialog boxes (e.g. File Properties, Print dialog etc.), no context-sensitive help is available.

- ▶ If the help is already displayed, press the softkey for which you want to display help.
A topic containing information about the softkey and its function is displayed.



If a softkey opens a submenu and you press the softkey a second time, the submenu of the softkey is displayed.

Contents of the help dialog box

The help dialog box contains four tabs:

- "Contents" - contains a table of help contents
- "View" - contains a specific help topic
- "Index" - contains index entries to search for help topics
- "Zoom" - contains zoom functions for the help display

To change between these tabs, press the tab on the touchscreen.

Navigating in the table of contents

- To move through the displayed contents entries, use the UP ARROW and DOWN ARROW keys. Entries that contain further entries are marked with a plus sign.
- To display a help topic, press the ENTER key. The "View" tab with the corresponding help topic is displayed.
- To change to the next tab, press the tab on the touchscreen.

Navigating in the help topics

- To scroll through a page, use the rotary knob or the UP ARROW and DOWN ARROW keys.
- To jump to the linked topic, press the link text on the touchscreen.

Searching for a topic

1. Change to the "Index" tab.

2. Enter the first characters of the topic you are interested in. The entries starting with these characters are displayed.
3. Change the focus by pressing the ENTER key.
4. Select the suitable keyword by using the UP ARROW or DOWN ARROW keys or the rotary knob.
5. Press the ENTER key to display the help topic.
The "View" tab with the corresponding help topic is displayed.

Changing the zoom

1. Change to the "Zoom" tab.
2. Set the zoom using the rotary knob. Four settings are available: 1-4. The smallest size is selected by number 1, the largest size is selected by number 4.

Closing the help window

- ▶ Press the ESC key or a function key on the front panel.

1.4 Notes for Users of R&S FSV 1307.9002Kxx Models

Users of R&S FSV 1307.9002Kxx models should consider the following differences to the description of the newer R&S FSV 1321.3008Kxx models:

- Functions that are based on the Windows7 operating system (e.g. printing or setting up networks) may have a slightly different appearance or require different settings on the Windows XP based models. For such functions, refer to the Windows documentation or the documentation originally provided with the R&S FSV instrument.
- The R&S FSV 1307.9002K03 model is restricted to a maximum frequency of 3 GHz, whereas the 1321.3008K04 model has a maximum frequency of 4 GHz.
- The bandwidth extension option R&S FSV-B160 (1311.2015.xx) is not available for the R&S FSV 1307.9002Kxx models. The maximum usable I/Q analysis bandwidth for these models is 28 MHz, or with option R&S FSV-B70, 40 MHz.

2 Introduction

This document contains all information required for operation of an R&S FSV equipped with Application Firmware R&S FSV. It covers operation via menus and the remote control commands for WLAN measurements.



This option is not available for R&S FSV 40 model 1307.9002K39.

This part of the documentation consists of the following chapters:

- [chapter 3.2, "Basic Measurement Examples"](#), on page 13
Describes the measurement setup for WLAN TX measurements.
- [chapter 4, "Instrument Functions WLAN TX Measurements"](#), on page 62
Describes the overall instrument functions and provides further information
- [chapter 4.1, "Softkeys of the WLAN TX Menu"](#), on page 63
Shows all softkeys available in the "WLAN" menu. This chapter also refers to the remote control commands associated with each softkey function.
- [chapter 5, "Remote Commands for WLAN TX Measurements"](#), on page 116
Describes all remote control commands defined for the power meter measurement.

This part of the documentation includes only functions of the Application Firmware R&S FSV-K91/91n/91ac/91p. For all other descriptions, please refer to the description of the base unit.

3 WLAN TX Measurements

The R&S FSV-K91/91n/91ac/91p application extends the functionality of the R&S FSV signal analyzer to enable wireless LAN TX measurements in accordance with IEEE standards 802.11 a, ac, b, g, j, n & p (assuming the required firmware option is installed).

The following topics are described in this section:

3.1	Introduction to WLAN 802.11A, AC, B, G, J, N & P TX Tests	12
3.2	Basic Measurement Examples	13
3.2.1	Setting Up the Measurement.....	13
3.2.2	Performing the Main Measurement.....	14
3.2.3	Setting up a MIMO measurement.....	14
3.3	Signal Processing of the IEEE 802.11a Application	21
3.3.1	Understanding Signal Processing of the IEEE 802.11a Application.....	22
3.3.2	Literature to the IEEE 802.11a Application.....	29
3.4	Signal Processing of the IEEE 802.11b Application	29
3.4.1	Understanding Signal Processing of the IEEE 802.11b Application.....	30
3.4.2	Literature of the IEEE 802.11b Application.....	35
3.5	802.11b RF Carrier Suppression	35
3.6	IEEE 802.11n/ac MIMO Measurements	36
3.6.1	Trigger Synchronization Using an R&S®FS-Z11 Trigger Unit.....	37
3.7	Signal Field Measurement (IEEE 802.11ac, n (SISO+MIMO))	39
3.8	Measurement Result Types	43
3.8.1	IQ Impairments.....	43
3.8.2	EVM Measurement.....	48
3.8.3	Rise/Fall Time Measurement.....	50
3.9	Measurement Settings and Result Displays	50
3.9.1	Measurement Settings.....	51
3.9.2	Result Summary List.....	54
3.9.3	Result Display Graph.....	59
3.9.4	Title Bar Information.....	61
3.9.5	Status Bar Information.....	61

3.1 Introduction to WLAN 802.11A, AC, B, G, J, N & P TX Tests

The use of an R&S FSV spectrum analyzer enables the accurate and reproducible TX measurement of a wireless LAN device under test (DUT) in accordance with the standards specified for the device. The following test conditions are supported:

Modulation formats:

- IEEE 802.11j (10 MHz)
 - BPSK (3 & 4.5 Mbps)
 - QPSK (6 & 9 Mbps)
 - 16QAM (12 & 18 Mbps)
 - 64QAM (24 & 27 Mbps)
- IEEE 802.11a, j & g (OFDM), p
 - BPSK (6 & 9 Mbps)
 - QPSK (12 & 18 Mbps)
 - 16QAM (24 & 36 Mbps)
 - 64QAM (48 & 54 Mbps)
- IEEE 802.11b & g (single carrier mode)
 - DBPSK (1 Mbps)
 - DQPSK (2 Mbps)
 - CCK (5.5 & 11 Mbps)
 - PBCC (5.5, 11 & 22 Mbps)
- IEEE 802.11ac (SISO and MIMO)
 - 16QAM
 - 64QAM
 - 256QAM

For IEEE 802.11n (MIMO) the modulation and data rates depend on the MCS index

- IEEE 802.11n (OFDM), (SISO and MIMO)
 - BPSK (6.5, 7.2, 13.5 & 15 Mbps)
 - QPSK (13, 14.4, 19.5, 21.7, 27, 30, 40.5 & 45 Mbps)
 - 16QAM(26, 28.9, 39, 43.3, 54, 60, 81 & 90 Mbps)
 - 64QAM(52, 57.8, 58.5, 65, 72.2, 108, 121.5, 135, 120, 135 & 150 Mbps)

For IEEE 802.11n (MIMO) the modulation and data rates depend on the MCS index



SISO vs MIMO

For most WLAN measurements, a single transmitter and a single receiver are used (SISO = single in, single out). For measurements according to the IEEE 802.11n or ac standards, the R&S FSV can measure multiple data streams between multiple transmitters and multiple receivers (MIMO = multiple in, multiple out).

For MIMO the modulation and data rates depend on the MCS index.

Modulation measurements

- Constellation diagram
- Constellation diagram for each OFDM carrier
- I/Q offset and I/Q imbalance
- Carrier and symbol frequency errors
- Modulation error (EVM) for each OFDM carrier or symbol
- Amplitude response and group-delay distortion (spectral flatness)

Further measurements and results

- Amplitude statistics (CCDF) and crest factor
- Transmit spectrum mask
- FFT, also over a selected part of the signal, e.g. preamble
- Payload bit information
- Freq/Phase Err vs. Preamble

3.2 Basic Measurement Examples

This section provides step-by-step instruction for working through an ordinary measurement. The following steps are described:

1. [chapter 3.2.1, "Setting Up the Measurement"](#), on page 13
2. [chapter 3.2.2, "Performing the Main Measurement"](#), on page 14

In this example, a DUT using IEEE 802.11a is to be used. The DUT is connected to the R&S FSV using the RF input of the R&S FSV. The DUT generates a signal modulated using 16QAM.

3.2.1 Setting Up the Measurement

1. Activate the "WLAN" mode using the MODE > "WLAN" keys.
2. Press the "FREQ" key once to select and open the [Demod Settings Dialog Box](#) and to activate the frequency input field.

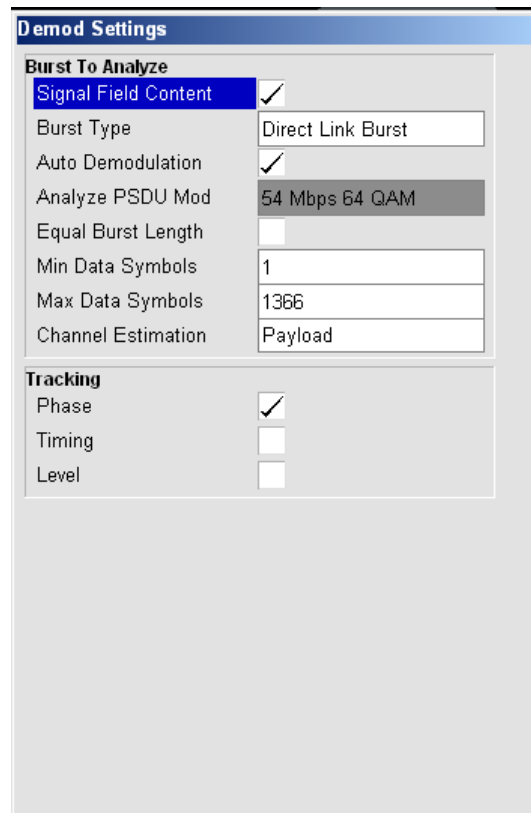

3. Activate "Auto Demodulation" (see "[Auto Demodulation \(IEEE 802.11n, SISO\)](#)" on page 99) to use the content of the signal inherent field to detect the modulation type automatically.

3.2.2 Performing the Main Measurement

- Select single sweep measurements by pressing the RUN SINGLE hardkey.
- Select continuous measurements by pressing the RUN CONT hardkey. During the measurement, the status message "Running" is displayed. Leveling is done automatically. Measurement results are updated once the measurement has completed. The results are displayed in graphical form. The display can be toggled to a tabular list of measurement points by pressing the "Display" softkey (in the "WLAN" menu or "Trace" menu).

3.2.3 Setting up a MIMO measurement

For this example a 2 Tx MIMO DUT according to IEEE 802.11n is used.

1. The MIMO DUT is connected to the analyzers according to the following setup:

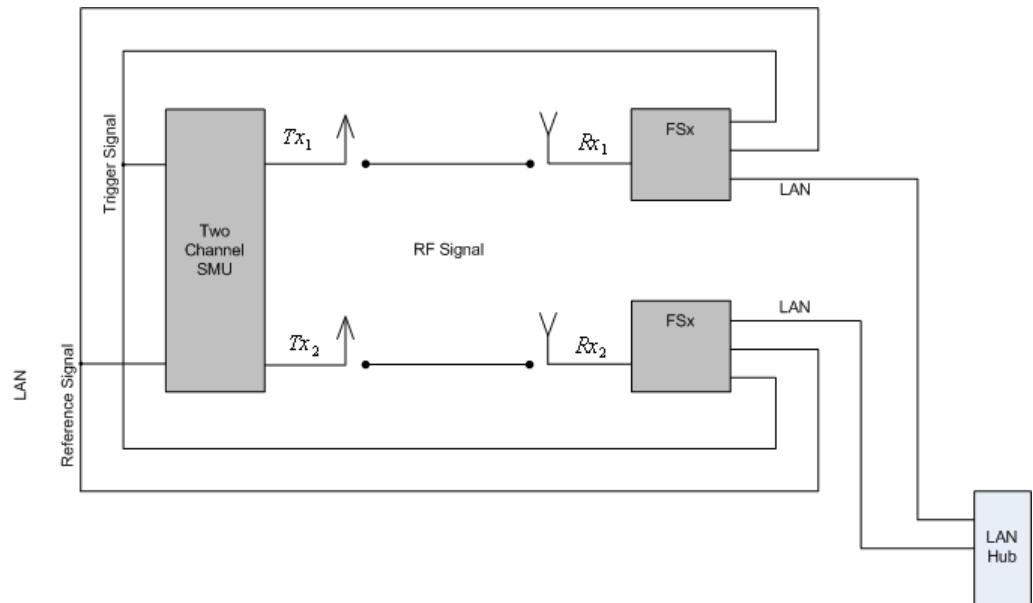

2. Connect the external reference REF OUT of the SMU with the external reference REF IN of the analyzers. Switch on the external reference for both analyzers in the spectrum analyzer base system.
3. Connect the marker output of the SMU with the EXT TRIGGER input of the analyzers.
4. Either connect the "Path A RF/Baseband" connector with one analyzer and the "Path B RF/Baseband" connector with the other analyzer, or use the air interface with appropriate antennas.
5. Connect the master and the slave analyzer via LAN according to the figure above. As an alternative, it is sufficient to connect master and slave with a cross LAN cable. The analyzer with the R&S FSV-K91n option can be used as master. The slave analyzer does not require a WLAN option.
6. Setup the SMU to generate a 2 Tx IEEE 802.11n (MIMO) signal. For the SMU "Baseband A" select the "IEEE 802.11n ..." option. This opens the "IEEE 802.11n WLAN A" dialog.

The screenshot shows the software interface for WLAN TX measurements. At the top, two channels (A and B) are configured with a frequency of 2.400 GHz, PEP of -20.00 dBm, and Level of -20.00 dBm. The 'IEEE 802.11n WLAN A' dialog box is open, showing the 'Transmission Bandwidth' dropdown menu with '40 MHz' selected. The main signal flow diagram shows two paths: Path A (WGN/IMP A, I/Q Mod A, RF/A Mod A) and Path B (WGN/IMP B, I/Q Mod B, RF/A Mod B). Path A is active, indicated by a blue box around the RF/A Mod A block. Path B is inactive, indicated by a grey box around the RF/A Mod B block. The 'BERT' block is also visible in the diagram.

7. Select the "Transmission Bandwidth" 40MHz.
In the "IEEE 802.11n WLAN A" dialog, press the "Frame Block Configuration ..." button to open the "IEEE 802.11n WLAN A: Frame Blocks Configuration" dialog.

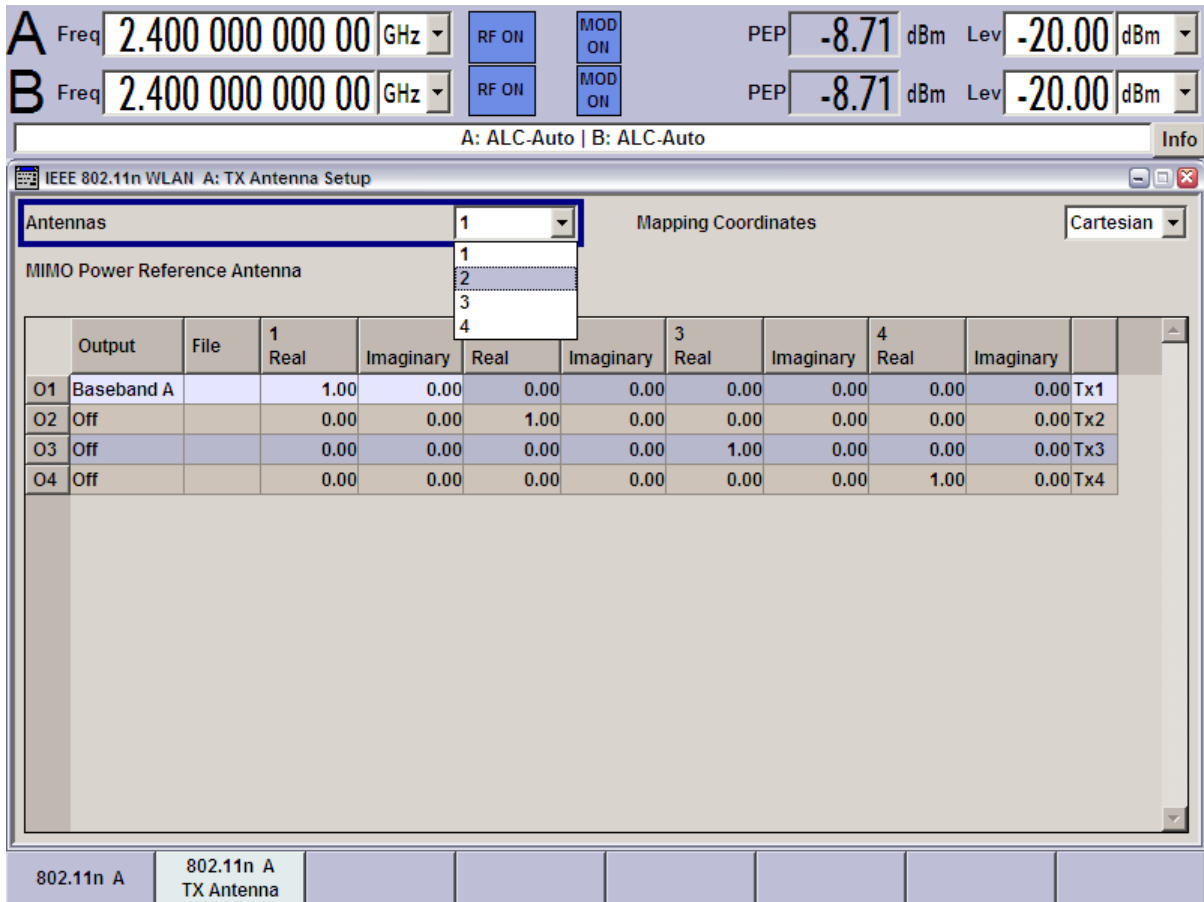

8. Select "Antennas" 2.
 In the "IEEE 802.11n WLAN A" dialog, press the "Frame Block Configuration ..." button to open the "IEEE 802.11n WLAN A: Frame Blocks Configuration" dialog.

IEEE 802.11n WLAN A: Frame Blocks Configuration

Type	Physical Mode	Tx Mode	Frames	Idle Time /ms	Data	DList / Pattern	Boost /dB	PPDU	Data Rate /Mbps	State
1 >	Data	Mixed Mode	HT-20MHz	1	0.100	PN 9	0.00	Config...	13.00	On

Legend:

- Legacy
- Mixed Mode
- Green Field
- Sounding

Buttons: Append, Insert, Delete, Copy, Paste

- Select "Tx Mode" *HT-40MHz*.
Press the "PPDU Config ..." button to open the "IEEE 802.11n WLAN A: PPDU Configuration for Frame Block 1" dialog.

A Freq 2.400 000 000 00 GHz RF ON MOD ON PEP -8.71 dBm Lev -20.00 dBm

B Freq 2.400 000 000 00 GHz RF ON MOD ON PEP -8.71 dBm Lev -20.00 dBm

A: ALC-Auto | B: ALC-Auto Info

IEEE 802.11n V IEEE 802.11n WLAN A: PPDU Configuration for Frame Block 1

Stream Settings

Spatial Streams 2 Extended Spatial Streams 0

Space Time Streams 2 Space Time Block Coding inactive

Spatial Stream Modulation

Stream 1 QPSK Stream 2 QPSK Stream 3 QPSK Stream 4 QPSK

Data Settings

Data Bits Per Symbol 216 Data Rate (Mbps) 54.00

Data Length 1024 bytes Number Of Data Symbols 39

Preamble/Header Active On Guard Long

Scrambler On (User Init) Scrambler Init (hex) 01

Channel Coding BCC Encoders 1 Rate 1/2

Interleaver Active On Service Field (hex) 0000

Append Insert Delete Copy Paste

10. Select "Spatial Streams" 2 and "Space Time Streams" 2.
Return to the "IEEE 802.11n WLAN A" dialog.

The screenshot displays the software interface for WLAN TX measurements. At the top, two channels (A and B) are configured with a frequency of 2.400 GHz, RF ON, MOD OFF, PEP of -20.00 dBm, and Lev of -20.00 dBm. Below this, a block diagram for IEEE 802.11n WLAN A is shown. The diagram illustrates two parallel paths, A and B. Path A includes WGN/IMP A, I/Q Mod A, and RF/A Mod A. Path B includes WGN/IMP B, I/Q Mod B, and RF/A Mod B. A BERT block is connected to the outputs of I/Q Mod A and I/Q Mod B. The RF/A Mod A and RF/A Mod B blocks are checked 'On'. The WGN/IMP A and WGN/IMP B blocks have 'On' checkboxes. The I/Q Mod A and I/Q Mod B blocks have 'On' checkboxes. The BERT block has an 'On' checkbox. The RF/A and RF/B outputs are indicated by arrows. On the left, a 'IEEE 802.11n WLAN A' configuration window is open, showing 'State' as 'Off', 'Transmission Bandwidth' as '40 MHz', and 'Configure Baseband B from Baseband A' checked. Other options include 'Transmit Antennas Setup...', 'Frame Block Configuration...', 'Clipping...', 'Trigger/Marker...', and 'Clock...'. The 'TX Antennas = 2' and 'Clip Off' options are also visible.

11. Check "Configure Baseband B from Baseband A". This will generate a IEEE 802.11n conform Tx 2 signal for path B of the SMU.
12. Toggle the "State" to *On* and make sure "RF/A Mod A" and "RF/B Mod B" are switched on.

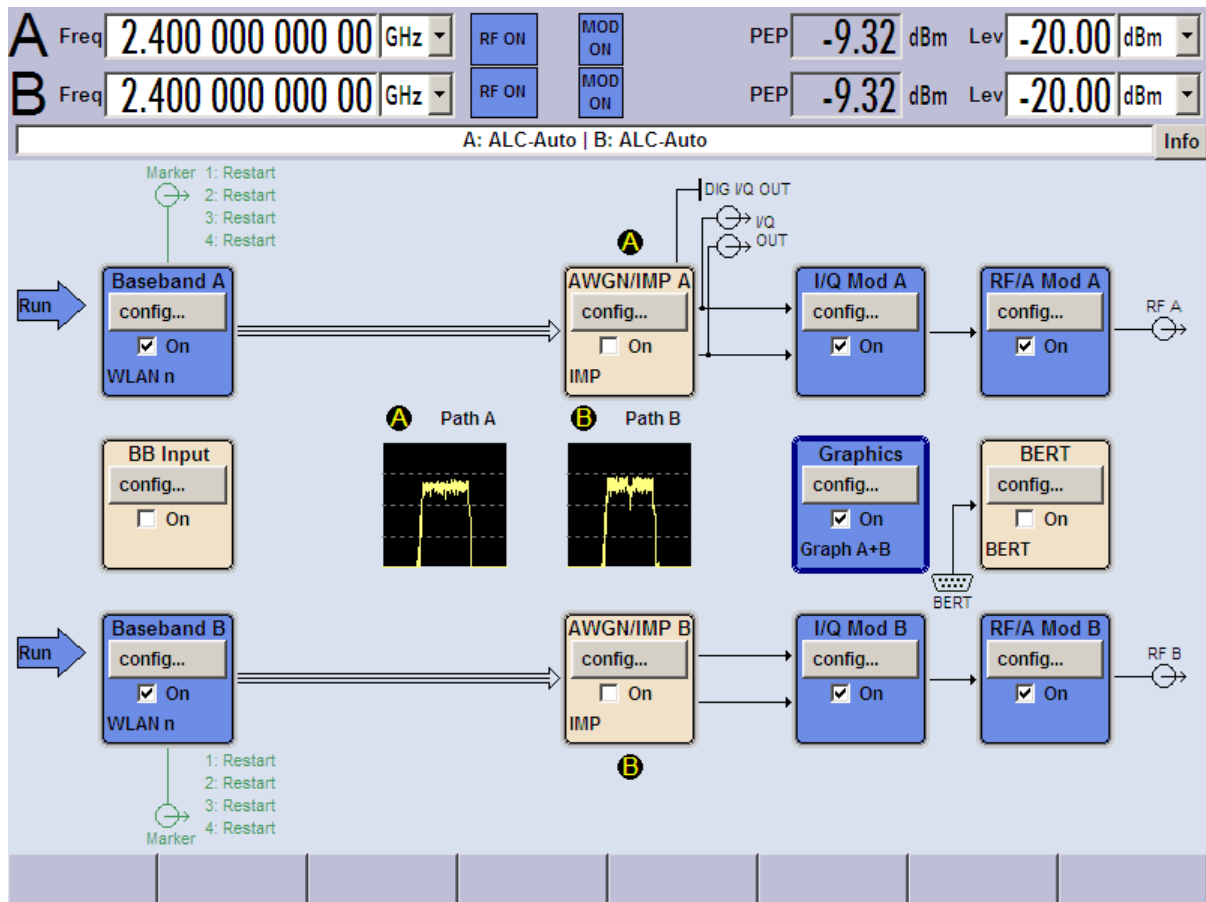

13. Using the "Graphics | Power Spectrum" display shows the power spectrum for both antennas.
14. Now set up the spectrum analyzer with the R&S FSV-K91n option to perform the WLAN MIMO measurements. Start the R&S FSV-K91n application.
15. Select "Standard" *IEEE 802.11n (MIMO)*.
Set the "RF Frequency" the DUT is transmitting.
16. Set "Trigger Mode" to "External".
Select the "STC/MIMO" tab in the "General Settings" dialog box.
17. Select "DUT MIMO configuration" *2 Tx Antennas*.
18. Set the "IP Address" of the slave in the "MIMO Measurement Setup" table and turn the "State" of the slave to *ON*.

3.3 Signal Processing of the IEEE 802.11a Application

This description gives a rough view of the IEEE 802.11a application signal processing. Details are disregarded in order to get a concept overview.

- [chapter 3.3.1, "Understanding Signal Processing of the IEEE 802.11a Application"](#), on page 22
- [chapter 3.3.2, "Literature to the IEEE 802.11a Application"](#), on page 29

Abbreviations

$a_{l,k}$	symbol at symbol l of subcarrier k
EVM_k	error vector magnitude of subcarrier k
EVM	error vector magnitude of current packet
g	signal gain
Δf	frequency deviation between TX and RX
l	symbol index $l = [1, \text{nof_Symbols}]$
nof_symbols	number of symbols of payload
H_k	channel transfer function of subcarrier k
k	channel index $k = [-31, 32]$
K_{mod}	modulation-dependent normalization factor
ξ	relative clock error of reference oscillator
$r_{l,k}$	subcarrier of symbol l

3.3.1 Understanding Signal Processing of the IEEE 802.11a Application

A diagram of the interesting blocks is shown in [figure 3-1](#). First the RF signal is down converted to the IF frequency $f_{\text{IF}} = 96$ MHz. The resulting IF signal $r_{\text{IF}}(t)$ is shown on the left-hand side of the figure. After bandpass filtering, the signal is sampled by an Analog to Digital Converter (ADC) at a sampling rate of $f_{s1} = 128$ MHz. This digital sequence is resampled. Thus the sampling rate of the down sampled sequence $r(i)$ is the Nyquist rate of $f_{s3} = 20$ MHz. Up to this point the digital part is implemented in an ASIC.

In the lower part of the figure the subsequent digital signal processing is shown. In the first block the packet search is performed. This block detects the Long Symbol (LS) and recovers the timing. The coarse timing is detected first. This search is implemented in the time domain. The algorithm is based on cyclic repetition within the LS after $N = 64$ samples. Numerous treatises exist on this subject, e.g. [1] to [3].

Furthermore a coarse estimate $\Delta \hat{f}_{\text{coarse}}$ of the Rx-Tx frequency offset Δf is derived from the metric in [6]. (The hat generally indicates an estimate, e.g. \hat{x} is the estimate of x .) This can easily be understood because the phase of $r(i) \Delta r^*(i + N)$ is determined by the frequency offset. As the frequency deviation Δf can exceed half a bin (distance between neighboring sub-carriers) the preceding Short Symbol (SS) is also analyzed in order to detect the ambiguity.

After the coarse timing calculation the time estimate is improved by the fine timing calculation. This is achieved by first estimating the coarse frequency response $\hat{H}^{(\text{LS})}_k$, with $k = [-26, 26]$ denoting the channel index of the occupied sub-carriers.

First the FFT of the LS is calculated. After the FFT calculation the known symbol information of the LS sub-carriers is removed by dividing by the symbols. The result is a coarse estimate \hat{H}_k of the channel transfer function.

In the next step the complex channel impulse response is computed by an IFFT. Next the energy of the windowed impulse response (the window size is equal to the guard period) is calculated for every trial time. Afterwards the trial time of the maximum energy is detected. This trial time is used to adjust the timing.

Now the position of the LS is known and the starting point of the useful part of the first payload symbol can be derived. In the next block this calculated time instant is used to position the payload window. Only the payload part is windowed. This is sufficient because the payload is the only subject of the subsequent measurements.

In the next block the windowed sequence is compensated by the coarse frequency estimate $\Delta \hat{f}_{\text{course}}$. This is necessary because otherwise inter channel interference (ICI) would occur in the frequency domain.

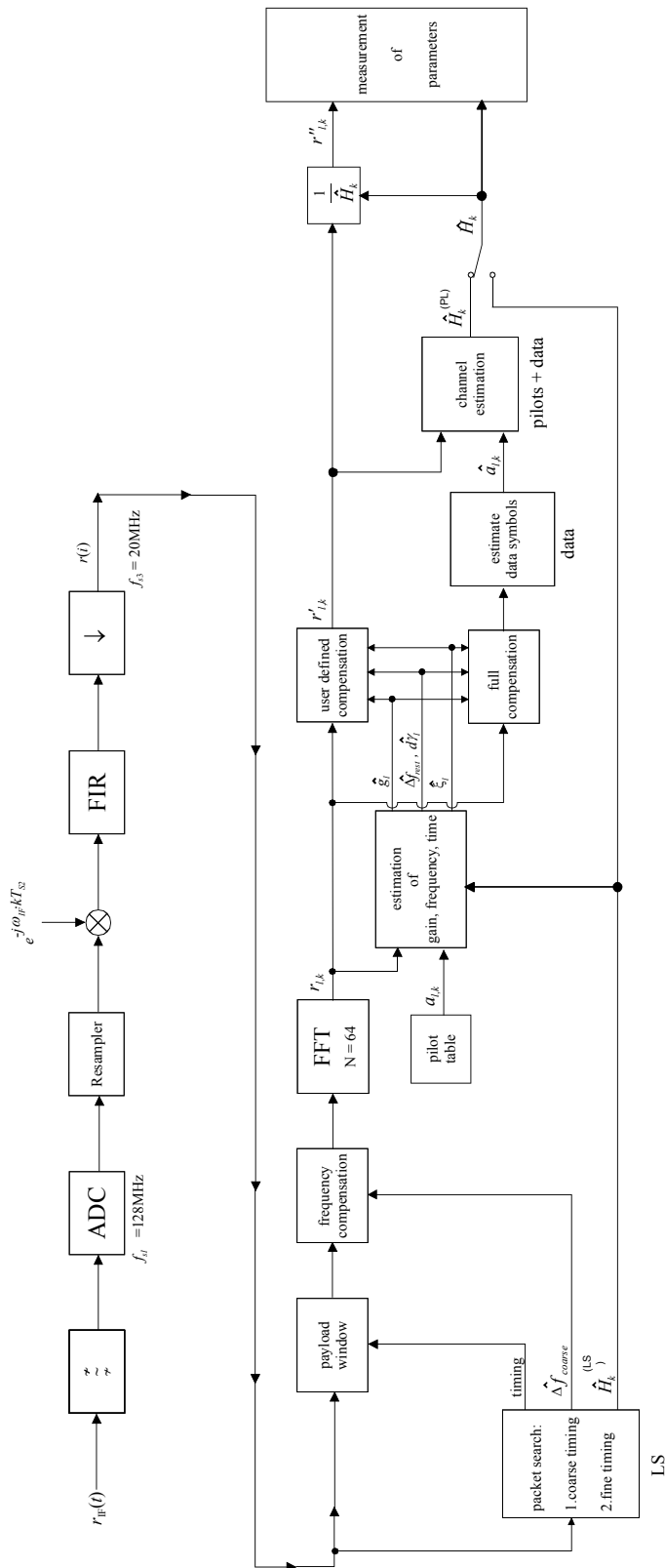

Fig. 3-1: Signal processing of the IEEE 802.11a application

The transition to the frequency domain is achieved by an FFT of length 64. The FFT is performed symbol-wise for every of the "nof_symbols" symbols of the payload. The calculated FFTs are described by $r_{l,k}$ with:

- $l = [1, \text{nof_symbols}]$ as the symbol index
- $k = [-31, 32]$ as the channel index

In case of an additive white Gaussian noise (AWGN) channel the FFT is described by [4], [5]

$$r_{l,k} = K_{\text{mod}} \times a_{l,k} \times g_l \times H_k \times e^{j(\text{phase}_l^{(\text{common})} + \text{phase}_{l,k}^{(\text{timing})})} + n_{l,k}$$

Equation (10) (3 - 1)

with:

- K_{mod} : the modulation-dependant normalization factor
- $a_{l,k}$: the symbol of sub-carrier k at symbol l
- g_l : the gain at the symbol l in relation to the reference gain $g = 1$ at the long symbol (LS)
- H_k : the channel frequency response at the long symbol (LS)
- $\text{phase}_l^{(\text{common})}$: the common phase drift phase of all sub-carriers at symbol l (see [Equation \(11\)](#))
- $\text{phase}_{l,k}^{(\text{timing})}$: the phase of sub-carrier k at symbol l caused by the timing drift (see [Equation \(11\)](#))
- $n_{l,k}$: the independent Gaussian distributed noise samples

The common phase drift in [Equation \(10\)](#) is given by:

$$\text{phase}_l^{(\text{common})} = 2\pi \times N_s / N \times \Delta f_{\text{rest}} T \times l + d\gamma_l$$

Equation (11) (3 - 2)

with

- $N_s = 80$: the number of Nyquist samples of the symbol period
- $N = 64$: the number of Nyquist samples of the useful part of the symbol
- Δf_{rest} : the (not yet compensated) frequency deviation
- $d\gamma_l$: the phase jitter at the symbol l

In general, the coarse frequency estimate $\Delta \hat{f}_{\text{coarse}}$ (see [Signal processing of the IEEE 802.11a application](#)) is not error-free. Therefore the remaining frequency error Δf_{rest} represents the frequency deviation in $r_{l,k}$ not yet compensated. Consequently, the overall frequency deviation of the device under test (DUT) is calculated by:

$$\Delta f = \Delta \hat{f}_{\text{coarse}} + \Delta f_{\text{rest}}$$



The only motivation for dividing the common phase drift in [Equation \(11\)](#) into two parts is to be able to calculate the overall frequency deviation of the DUT.

The reason for the phase jitter $\Delta\phi_l$ in Equation (11) may be different. The nonlinear part of the phase jitter may be caused by the phase noise of the DUT oscillator. Another reason for nonlinear phase jitter may be the increase of the DUT amplifier temperature at the beginning of the burst. Note that besides the nonlinear part the phase jitter, $\Delta\phi_l$ also contains a constant part. This constant part is caused by the frequency deviation Δf_{rest} not yet compensated. To understand this, keep in mind that the measurement of the phase starts at the first symbol $l = 1$ of the payload. In contrast the channel frequency response H_k in Equation (10) represents the channel at the long symbol of the preamble. Consequently, the frequency deviation Δf_{rest} not yet compensated produces a phase drift between the long symbol and the first symbol of the payload. Therefore, this phase drift appears as a constant value ("DC value") in $\Delta\phi_l$.

Referring to the IEEE 802.11a measurement standard Chapter 17.3.9.7 "Transmit modulation accuracy test" [6], the common phase drift $\text{phase}_{l,k}^{(\text{common})}$ must be estimated and compensated from the pilots. Therefore this "symbol-wise phase tracking" (Tracking Phase) is activated as the default setting of the R&S FSV-K91/91n.

Furthermore, the timing drift in Equation (10) is given by:

$$\text{phase}_{l,k}^{(\text{timing})} = 2\pi \times N_s / N \times \xi \times k \times l$$

Equation (12) (3 - 3)

with ξ : the relative clock deviation of the reference oscillator

Normally, a symbol-wise timing jitter is negligible and thus not modeled in Equation (12). However, there may be situations where the timing drift has to be taken into account. This is illustrated by an example: In accordance to [6], the allowed clock deviation of the DUT is up to $\xi_{\text{max}} = 20$ ppm. Furthermore, a long packet with 400 symbols is assumed. The result of Equation (10) and Equation (12), is that the phase drift of the highest sub-carrier $k = 26$ in the last symbol $l = \text{nof_symbols}$ is 93 degrees. Even in the noise-free case, this would lead to symbol errors. The example shows that it is actually necessary to estimate and compensate the clock deviation, which is accomplished in the next block.

Referring to the IEEE 802.11a measurement standard [6], the timing drift $\text{phase}_{l,k}^{(\text{timing})}$ is not part of the requirements. Therefore the "time tracking" (Tracking Time) is not activated as the default setting of the R&S FSV-K91/91n. The time tracking option should rather be seen as a powerful analyzing option.

In addition, the tracking of the gain g_l in Equation (10) is supported for each symbol in relation to the reference gain $g = 1$ at the time instant of the long symbol (LS). At this time the coarse channel transfer function $\hat{H}_k^{(\text{LS})}$ is calculated.

This makes sense since the sequence $r'_{l,k}$ is compensated by the coarse channel transfer function $\hat{H}_k^{(\text{LS})}$ before estimating the symbols. Consequently, a potential change of the gain at the symbol l (caused, for example, by the increase of the DUT amplifier temperature) may lead to symbol errors especially for a large symbol alphabet M of the MQAM transmission. In this case the estimation and the subsequent compensation of the gain are useful.

Referring to the IEEE 802.11a measurement standard [6], the compensation of the gain g_l is not part of the requirements. Therefore the "gain tracking" (Tracking Gain) is not activated as the default setting of the R&S FSV-K91/91n.

How can the parameters above be calculated? In this application the optimum maximum likelihood algorithm is used. In the first estimation step the symbol-independent parameters Δf_{rest} and ξ are estimated. The symbol dependent parameters can be neglected in this step, i.e. the parameters are set to $g_l = 1$ and $d\gamma = 0$. Referring to Equation (10), the log likelihood function L must be calculated as a function of the trial parameters $\tilde{\Delta f}_{rest}$ and $\tilde{\xi}$. (The tilde generally describes a trial parameter. Example: \tilde{x} is the trial parameter of x .)

$$L_1(\tilde{\Delta f}_{rest}, \tilde{\xi}) = \sum_{l=1}^{no\ of\ symbols} \sum_{k=-21,-7,7,21} \left| r_{l,k} - a_{l,k} \times \tilde{H}_k^{(LS)} \times e^{j(\tilde{phase}_l^{(common)} + \tilde{phase}_l^{(time\ in\ g)})} \right|^2$$

with

$$\tilde{phase}_l^{(common)} = 2\pi \times N_s / N \times \tilde{\Delta f}_{rest} T \times l$$

$$\tilde{phase}_l^{(time\ in\ g)} = 2\pi \times N_s / N \times \tilde{\xi} \times k \times l$$

(13a) (3 - 4)

The trial parameters leading to the minimum of the log likelihood function are used as estimates $\hat{\Delta f}_{rest}$ and $\hat{\xi}$. In (13a) the known pilot symbols $a_{l,k}$ are read from a table.

In the second step, the log likelihood function is calculated for every symbol l as a function of the trial parameters \tilde{g}_l and $d\tilde{\gamma}_l$:

$$L_2(\tilde{g}_l, d\tilde{\gamma}_l) = \sum_{k=-21,-7,7,21} \left| r_{l,k} - a_{l,k} \times \tilde{g}_l \times \tilde{H}_k^{(LS)} \times e^{j(\tilde{phase}_l^{(common)} + \tilde{phase}_l^{(time\ in\ g)})} \right|^2$$

with

$$\tilde{phase}_l^{(common)} = 2\pi \times N_s / N \times \tilde{\Delta f}_{rest} T \times l + d\tilde{\gamma}_l$$

$$\tilde{phase}_l^{(time\ in\ g)} = 2\pi \times N_s / N \times \tilde{\xi} \times k \times l$$

(13b) (3 - 5)

Finally, the trial parameters leading to the minimum of the log likelihood function are used as estimates \hat{g}_l and $d\hat{\gamma}_l$.

This robust algorithm works well even at low signal to noise ratios with the Cramer Rao Bound being reached.

After estimation of the parameters, the sequence $r_{l,k}$ is compensated in the compensation blocks.

In the upper analyzing branch the compensation is user-defined i.e. the user determines which of the parameters are compensated. This is useful in order to extract the influence of these parameters. The resulting output sequence is described by: $\hat{\gamma}'_{\delta,k}$.

In the lower compensation branch the full compensation is always performed. This separate compensation is necessary in order to avoid symbol errors. After the full compensation the secure estimation of the data symbols $\hat{a}_{l,k}$ is performed. From Equation

(10) it is clear that first the channel transfer function H_k must be removed. This is achieved by dividing the known coarse channel estimate $\hat{H}^{(LS)}_k$ calculated from the LS. Usually an error free estimation of the data symbols can be assumed.

In the next block a better channel estimate $\hat{H}^{(PL)}_k$ of the data and pilot sub-carriers is calculated by using all `nof_symbols` symbols of the payload (PL). This can be accomplished at this point because the phase is compensated and the data symbols are known. The long observation interval of `nof_symbols` symbols (compared to the short interval of 2 symbols for the estimation of $\hat{H}^{(LS)}_k$) leads to a nearly error-free channel estimate.

In the following equalizer block $\hat{H}^{(LS)}_k$ is compensated by the channel estimate. The resulting channel-compensated sequence is described by $y_{\delta,k}$. The user may either choose the coarse channel estimate $\hat{H}^{(LS)}_k$ (from the long symbol) or the nearly error-free channel estimate $\hat{H}^{(PL)}_k$ (from the payload) for equalization. If the improved estimate $\hat{H}^{(LS)}_k$ is used, a 2 dB reduction of the subsequent EVM measurement can be expected.

According to the IEEE 802.11a measurement standard [6], the coarse channel estimation $\hat{H}^{(LS)}_k$ (from the long symbol) has to be used for equalization. Therefore the default setting of the R&S FSV-K91/91n is equalization from the coarse channel estimate derived from the long symbol.

In the last block the measurement variables are calculated. The most important variable is the error vector magnitude of the sub-carrier "k" of the current packet:

$$\overline{EVM} = \sqrt{\frac{1}{\text{nof_packets}} \sum_{\text{counter}=1}^{\text{nof_packets}} EVM^2(\text{counter})} \quad (14) \quad (3 - 6)$$

Furthermore, the packet error vector magnitude is derived by averaging the squared EVM_k versus k:

$$EVM = \sqrt{\frac{1}{52} \sum_{k=-26(k \neq 0)}^{26} EVM_k^2} \quad (15) \quad (3 - 7)$$

Finally, the average error vector magnitude is calculated by averaging the packet EVM of all `nof_symbols` detected packets:

$$EVM_k = \sqrt{\frac{1}{\text{nof_symbols}} \sum_{l=1}^{\text{nof_symbols}} |r_{l,k}^n - K_{\text{mod}} \times a_{l,k}|^2} \quad (16) \quad (3 - 8)$$

This parameter is equivalent to the so-called "RMS average of all errors": $\text{Error}_{\text{RMS}}$ of the IEEE 802.11a measurement commandment (see [6],).

3.3.2 Literature to the IEEE 802.11a Application

[1]	Speth, Classen, Meyr: "Frame synchronization of OFDM systems in frequency selective fading channels", VTC '97, pp. 1807-1811
[2]	Schmidl, Cox: "Robust Frequency and Timing Synchronization of OFDM", IEEE Trans. on Comm., Dec. 1997, pp. 1613-621
[3]	Minn, Zeng, Bhargava: "On Timing Offset Estimation for OFDM", IEEE Communication Letters, July 2000, pp. 242-244
[4]	Speth, Fechtel, Fock, Meyr: "Optimum Receiver Design for Wireless Broad-Band Systems Using OFDM – Part I", IEEE Trans. On Comm. VOL. 47, NO 11, Nov. 1999
[5]	Speth, Fechtel, Fock, Meyr: "Optimum Receiver Design for Wireless Broad-Band Systems Using OFDM – Part II", IEEE Trans. On Comm. VOL. 49, NO 4, April. 2001
[6]	IEEE 802.11a, Part 11: Wireless LAN Medium Access Control (MAC) and Physical Layer (PHY) specifications

3.4 Signal Processing of the IEEE 802.11b Application

This description gives a rough overview of the signal processing concept of the IEEE 802.11b application.

- [chapter 3.4.1, "Understanding Signal Processing of the IEEE 802.11b Application"](#), on page 30
- [chapter 3.4.2, "Literature of the IEEE 802.11b Application"](#), on page 35

Abbreviations

ε	timing offset
Δf	frequency offset
$\Delta\phi$	phase offset
$\text{ARG}\{\dots\}$	calculation of the angle of a complex value
EVM	error vector magnitude
\hat{g}_I	estimate of the gain factor in the I-branch
\hat{g}_Q	estimate of the gain factor in the Q-branch
$\Delta\hat{g}_Q$	accurate estimate of the crosstalk factor of the Q-branch in the I-branch
$\hat{h}_s(v)$	estimated baseband filter of the transmitter
$\hat{h}_r(v)$	estimated baseband filter of the receiver
$\hat{\delta}_I$	estimate of the IQ-offset in the I-branch
$\hat{\delta}_Q$	estimate of the IQ-offset in the I-branch
$r(v)$	measurement signal
$\hat{s}(v)$	estimate of the reference signal

$\hat{s}_n(v)$	estimate of the power normalized and undisturbed reference signal
REAL{...}	calculation of the real part of a complex value
IMAG{...}	calculation of the imaginary part of a complex value

3.4.1 Understanding Signal Processing of the IEEE 802.11b Application

A block diagram of the measurement application is shown below in [figure 3-2](#). The baseband signal of an IEEE 802.11b wireless LAN system transmitter is sampled with a sampling rate of 44 MHz.

The first task of the measurement application is to detect the position of the bursts within the measurement signal $r_1(v)$. The detection algorithm is able to find the positions of the beginning of short and long bursts and can distinguish between them. The algorithm also detects the initial state of the scrambler. This is required if IEEE 802.11 signals should be analyzed, because this standard does not specify the initial state of the scrambler.

With the knowledge of the start position of the burst, the header of the burst can be demodulated. The bits transmitted in the header provide information about the length of the burst and the modulation type used in the PSDU.

After the start position and the burst length is fully known, better estimates of timing offset, timing drift, frequency offset and phase offset can be calculated using the entire data of the burst.

At this point of the signal processing a demodulation can be performed without decision error. After demodulation the normalized and undisturbed reference signal $s(v)$ is available.

If the frequency offset is not constant and varies with time, the frequency- and phase offset in several partitions of the burst must be estimated and corrected. Additionally, timing offset, timing drift and gain factor can be estimated and corrected in several partitions of the burst. These corrections can be separately switched off in the "Demod Settings" menu.

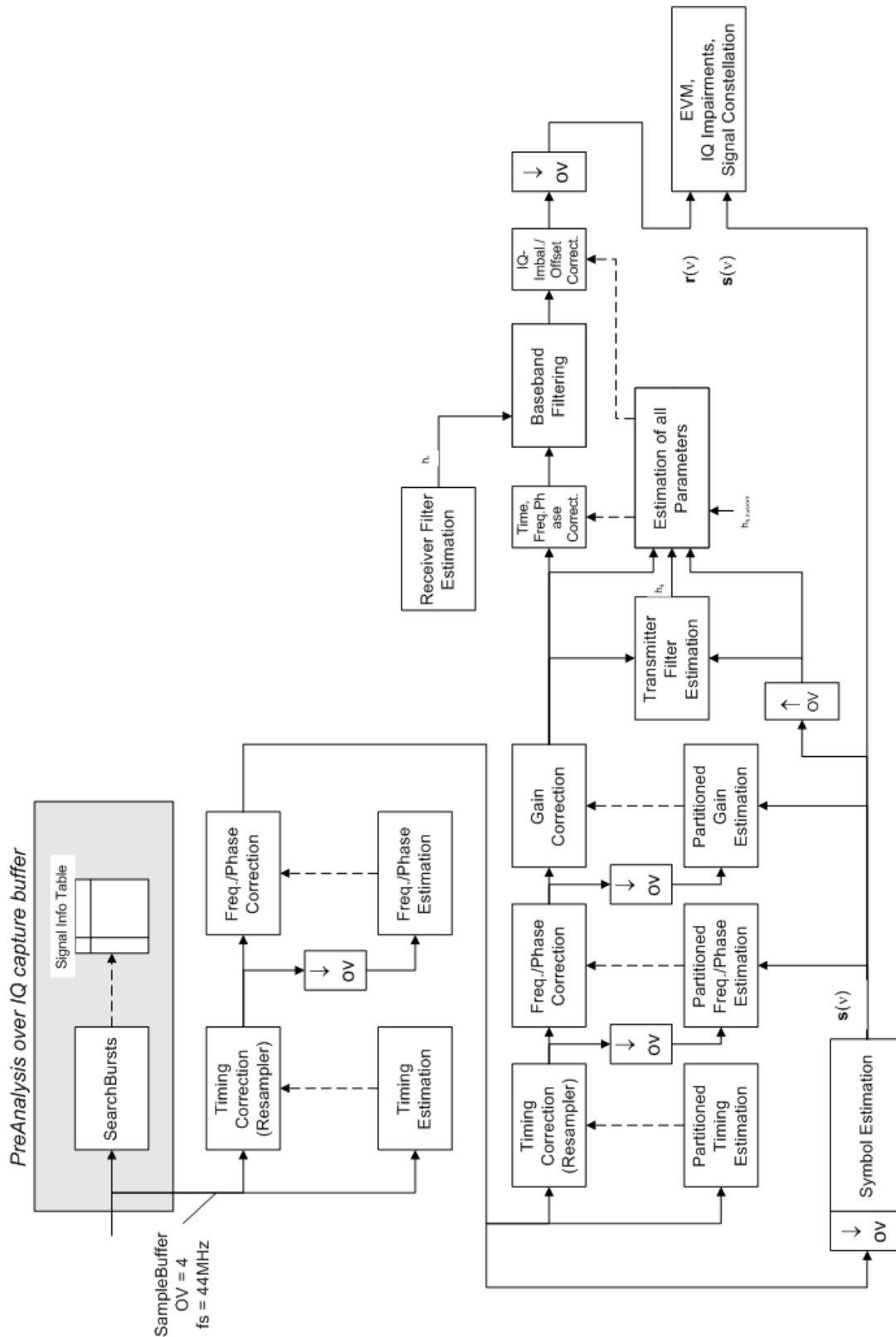

Fig. 3-2: Signal processing of the IEEE 802.11b application

Knowing the normalized power and undisturbed reference signal, the transmitter base-band filter is estimated by minimizing the cost function of a maximum-likelihood-based estimator:

$$L_1 = \sum_{v=0}^{M-1} \left| r(v) \times e^{-j2\pi\tilde{\nu}v} \times e^{-j\Delta\tilde{\phi}} - \sum_{i=-L}^{+L} \tilde{h}_s(i) \times \tilde{s}_s(v-i) - \tilde{\sigma}_I - j\tilde{\sigma}_Q \right|^2 \quad (17) \quad (3 - 9)$$

where:

$r(v)$: the oversampled measurement signal

\hat{s} : the normalized oversampled power

$s_n(v)$: the undisturbed reference signal

N : the observation length

L : the filter length

$\Delta\tilde{\nu}$: the variation parameters of the frequency offset

$\Delta\tilde{\phi}$: the variation parameters of the phase offset

$\tilde{\sigma}_I, \tilde{\sigma}_Q$: the variation parameters of the IQ-offset

$\tilde{h}_s(v)$: the coefficients of the transmitter filter

The frequency-, the phase- and the IQ-offset are estimated jointly with the coefficients of the transmitter filter to increase the estimation quality.

Once the transmitter filter is known, all other unknown signal parameters are estimated with a maximum-likelihood-based estimation, which minimizes the cost function:

$$L_2 = \sum_{v=0}^{N-1} \left| r(v - \tilde{\varepsilon}) \times e^{-j2\pi\tilde{\nu}v} \times e^{-j\Delta\tilde{\phi}} - \tilde{g}_I \times s_I(v) - j\tilde{g}_Q \times s_Q(v) + \Delta\tilde{g}_Q \times s_Q(v) - \tilde{\sigma}_I - j\tilde{\sigma}_Q \right|^2 \quad (18) \quad (3 - 10)$$

where:

\tilde{g}_I, \tilde{g}_Q : the variation parameters of the gain used in the I/Q-branch

$\Delta\tilde{g}_Q$: the crosstalk factor of the Q-branch into the I-branch

$s_I(v), s_Q(v)$: the filtered reference signal of the I/Q-branch.

The unknown signal parameters are estimated in a joint estimation process to increase the accuracy of the estimates.

The accurate estimates of the frequency offset, the IQ-imbalance, the quadrature-mismatch and the normalized IQ-offset are displayed by the measurement software. The IQ-imbalance is the quotient of the estimates of the gain factor of the Q-branch, the crosstalk factor and the gain factor of the I-branch:

$$IQ - Imbalance = \left| \frac{\hat{g}_Q + \Delta \hat{g}_Q}{\hat{g}_I} \right| \quad (19) \quad (3 - 11)$$

The quadrature-mismatch is a measure for the crosstalk of the Q-branch into the I-branch:

$$Quadrature - Mismatch = \text{ARC}\{\hat{g}_Q + j \times \Delta \hat{g}_Q\} \quad (20) \quad (3 - 12)$$

The normalized IQ-offset is defined as the magnitude of the IQ-offset normalized by the magnitude of the reference signal:

$$IQ - Offset = \frac{\sqrt{\hat{\sigma}_I^2 + \hat{\sigma}_Q^2}}{\sqrt{\frac{1}{2} \cdot [\hat{g}_I^2 + \hat{g}_Q^2]}} \quad (21) \quad (3 - 13)$$

At this point of the signal processing all unknown signal parameters such as timing-, frequency-, phase-, IQ-offset and IQ-imbalance have been evaluated and the measurement signal can be corrected accordingly.

Using the corrected measurement signal $r(v)$ and the estimated reference signal $\hat{s}(v)$, the modulation quality parameters can be calculated. The mean error vector magnitude (EVM) is the quotient of the root-mean-square values of the error signal power and the reference signal power:

$$EVM = \frac{\sqrt{\sum_{v=0}^{N-1} |r(v) - \hat{s}(v)|^2}}{\sqrt{\sum_{v=0}^{N-1} |\hat{s}(v)|^2}} \quad (22) \quad (3 - 14)$$

Whereas the instant error vector magnitude is the momentary error signal magnitude normalized by the root mean square value of the reference signal power:

$$EVM(v) = \frac{|r(v) - \hat{s}(v)|}{\sqrt{\sum_{v=0}^{N-1} |\hat{s}(v)|^2}} \quad (23) \quad (3 - 15)$$

In [2] a different algorithm is proposed to calculate the error vector magnitude. In a first step the IQ-offset in the I-branch and the IQ-offset of the Q-branch are estimated separately:

$$\hat{\sigma}_I = \frac{1}{N} \sum_{v=0}^{N-1} \text{REAL}\{r(v)\} \quad (24) \text{ (3 - 16)}$$

$$\hat{\sigma}_Q = \frac{1}{N} \sum_{v=0}^{N-1} \text{IMAG}\{r(v)\} \quad (25) \text{ (3 - 17)}$$

where $r(v)$ is the measurement signal which has been corrected with the estimates of the timing-, frequency- and phase offset, but not with the estimates of the IQ-imbalance and IQ-offset

With these values the IQ-imbalance of the I-branch and the IQ-imbalance of the Q-branch are estimated in a non-linear estimation in a second step:

$$\hat{g}_I = \frac{1}{N} \sum_{v=0}^{N-1} |\text{REAL}\{r(v) - \hat{\sigma}_I\}| \quad (26) \text{ (3 - 18)}$$

$$\hat{g}_Q = \frac{1}{N} \sum_{v=0}^{N-1} |\text{IMAG}\{r(v) - \hat{\sigma}_Q\}| \quad (27) \text{ (3 - 19)}$$

Finally, the mean error vector magnitude can be calculated with a non-data-aided calculation:

$$V_{\text{err}}(v) = \frac{\sqrt{\frac{1}{2} \sum_{v=0}^{N-1} [|\text{REAL}\{r(v)\} - \hat{\sigma}_I| - \hat{g}_I]^2 + \frac{1}{2} \sum_{v=0}^{N-1} [|\text{IMAG}\{r(v)\} - \hat{\sigma}_Q| - \hat{g}_Q]^2}}{\sqrt{\frac{1}{2} \cdot [\hat{g}_I^2 + \hat{g}_Q^2]}} \quad (28) \text{ (3 - 20)}$$

The instant error vector magnitude is the error signal magnitude normalized by the root mean square value of the estimate of the measurement signal power:

$$V_{\text{err}}(v) = \frac{\sqrt{\frac{1}{2} [|\text{REAL}\{r(v)\} - \hat{\sigma}_I| - \hat{g}_I]^2 + \frac{1}{2} [|\text{IMAG}\{r(v)\} - \hat{\sigma}_Q| - \hat{g}_Q]^2}}{\sqrt{\frac{1}{2} \cdot [\hat{g}_I^2 + \hat{g}_Q^2]}} \quad (29) \text{ (3 - 21)}$$

The advantage of this method is that no estimate of the reference signal is needed, but the IQ-offset and IQ-imbalance values are not estimated in a joint estimation procedure. Therefore, each estimation parameter is disturbing the estimation of the other

parameter and the accuracy of the estimates is lower than the accuracy of the estimations achieved by (17). If the EVM value is dominated by Gaussian noise this method yields similar results as (18).

3.4.2 Literature of the IEEE 802.11b Application

[1]	Institute of Electrical and Electronic Engineers, Part 11: Wireless LAN Medium Access Control (MAC) and Physical Layer (PHY) specifications, IEEE Std 802.11-1999, Institute of Electrical and Electronic Engineers, Inc., 1999.
[2]	Institute of Electrical and Electronic Engineers, Part 11: Wireless LAN Medium Access Control (MAC) and Physical Layer (PHY) specifications: Higher-Speed Physical Layer Extensions in the 2.4 GHz Band, IEEE Std 802.11b-1999, Institute of Electrical and Electronic Engineers, Inc., 1999.

3.5 802.11b RF Carrier Suppression

Definition

The RF carrier suppression, measured at the channel center frequency, shall be at least 15 dB below the peak SIN(x)/x power spectrum. The RF carrier suppression shall be measured while transmitting a repetitive 01 data sequence with the scrambler disabled using DQPSK modulation. A 100 kHz resolution bandwidth shall be used to perform this measurement.

Comparison to IQ offset measurement in R&S FSV-K91/91n list mode

The IQ offset measurement in R&S FSV-K91/91n returns the actual carrier feed through normalized to the mean power at the symbol timings. This measurement doesn't need a special test signal and is independent of the transmit filter shape.

The RF carrier suppression measured according to the standard is inversely proportional to the IQ offset measured in R&S FSV-K91/91n list mode. The difference (in dB) between the two values depends on the transmit filter shape and should be determined with one reference measurement.

The following table lists exemplary the difference for three transmit filter shapes (± 0.5 db):

Transmit filter	– IQ-Offset [dB] – RF-Carrier-Suppression [dB]
Rectangular	11 dB
Root raised cosine, " α " = 0.3	10 dB
Gaussian, " α " = 0.3	9 dB

3.6 IEEE 802.11n/ac MIMO Measurements

For measurements according to the IEEE 802.11n or ac standard, the R&S FSV can measure multiple data streams between multiple transmitters and multiple receivers (MIMO = multiple in, multiple out).

To understand which results come from which part of the data flow it is sensible to have a look at the fundamental processing in transmitter and receiver. The following figure shows the basic processing steps needed at the transmitter and the complementary blocks in reverse order applied at the receiver:

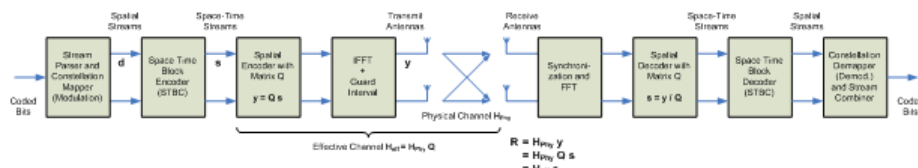

Fig. 3-3: Transmitter-Receiver block diagram

Especially of interest is the representation of specific results, i.e. for which sections of the processing the results are shown. Usually results are calculated according to particular signal processing steps in the transmitter (except for the results “Burst Power” and “Crest Factor” which refer to the receive antennas):

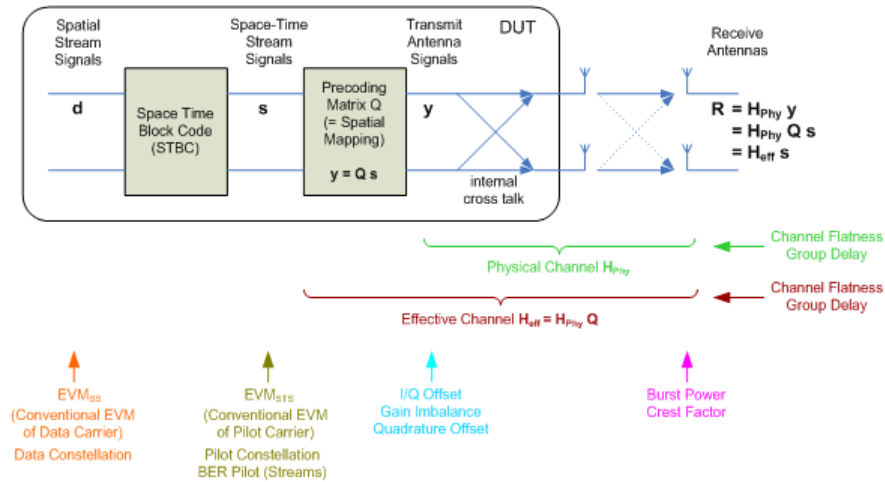

Fig. 3-4: Possible results and Channel Representation (effective / physical)

For example EVM and Constellation results are calculated according to the spatial or space time streams in the transmitter, i.e. by using the effective channel which includes the spatial mapping. Since Space Time Block Encoding is only applied to data carriers but pilot carriers are inserted without STBC, the EVM analysis is applied to spatial streams (STBC decoded) for data carriers and to space time streams for pilot streams. As a consequence we might get results (EVM and Constellation) for a different number of streams for data and pilot carriers if STBC is applied. For example using 2x2 MIMO with active STBC we get only pilot carriers in the second stream, because due to STBC there is only one spatial (data) stream but 2 space time (pilot) streams.

In contrast the I/Q Offset, Gain Imbalance and Quadrature Offset results are calculated for the transmit antenna signals. I.e. they are corresponding to the physical channel. $H_{\text{Phy}} = H_{\text{eff}}Q^{-1}$ I.e. in order to determine the physical channel from the effective channel, the precoding matrix Q (spatial mapping) must be invertible. Note that “transmit antenna signals” means the ideal transmit signal so that the estimated channel transfer functions include cross talk (between the antennas) introduced by the DUT, the connection between DUT and Analyzer and the Analyzer itself (whereas we regard the cross terms contributed by the cable connection and the Analyzer hardware as to be negligible).

Furthermore the spectral results (channel flatness and group delay) are available for the effective and the physical channel, i.e. based on streams or Tx antennas. Note that the physical channel is not in any case derivable from the initially estimated effective channel (but only if the precoding matrix is invertible) and thus the physical channel results are only available under specific conditions. In contrast the effective channel results are always available. This can be explained by the fact, that the channel estimation is done on the HT-LTF fields of the preamble (see figure below), which are transmitted by one individual (known) preamble symbol per each space time stream and therefore allowing to estimate the channel map between Rx Antennas and space time streams in the first step:

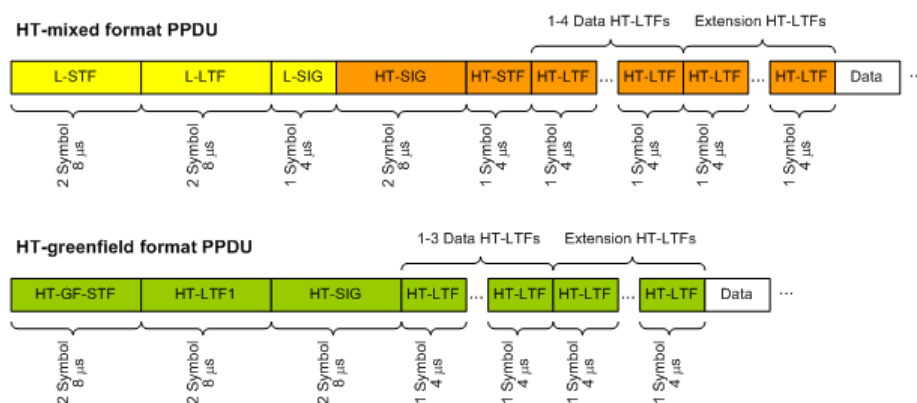

Fig. 3-5: Possible results and Channel Representation (effective / physical)

The so estimated effective channel (using HT-LTF fields as described above) can then be transformed into the physical channel (map between Rx and Tx Antenna signals) by applying the inverse mapping matrix Q. Now it is clear, that the physical channel can only be calculated if Q can be inverted. For example this is not the case if the signal contains less space time streams than Tx antennas.

3.6.1 Trigger Synchronization Using an R&S®FS-Z11 Trigger Unit

For simultaneous MIMO measurements, it is important to analyze the Tx antenna signals sent at the same instant of time from the Device Under Test (DUT). The R&S®FS-Z11 Trigger Unit can ensure that all analyzers start capturing I/Q data at the same time.

The trigger unit is connected to the DUT and all involved analyzers. Then the trigger unit can be used in the following operating modes:

- **External mode:** If the DUT has a trigger output, the trigger signal from the DUT triggers all analyzers simultaneously.
The DUT's TRIGGER OUTPUT is connected to the trigger unit's TRIG INPUT connector. Each of the trigger unit's TRIG OUT connectors is connected to one of the analyzers' TRIGGER INPUT connector.
The trigger unit routes the trigger signal from TRIG INPUT to TRIG OUT 1 to 4, and thus to the the trigger inputs of the connected analyzers.
- **Free Run mode:** This mode is used if no DUT trigger signal is available or the MIMO signals are simply to be captured at the same (random) time. No connection to the trigger signal of the DUT is required. The master analyzer sends a trigger impulse to the trigger unit - via the NOISE SOURCE CONTROL output - to start the measurement as soon as all slave analyzers are ready to measure.
The NOISE SOURCE CONTROL output of the master analyzer is connected to the trigger unit's NOISE SOURCE CONTROL input. Each of the trigger unit's TRIG OUT connectors is connected to one of the analyzers' TRIGGER INPUT connector. When the master analyzer sends a signal to the trigger unit via its NOISE SOURCE CONTROL output, the trigger unit triggers all analyzers simultaneously via its TRIGGER OUTPUTs.
Note: in Free Run mode you have to make sure the TRIG INPUT on the trigger unit remains open, that is: not connected.
- **Manual mode:** a trigger is generated by the trigger unit and triggers all analyzers simultaneously. No connection to the DUT is required.
Each of the trigger unit's TRIG OUT connectors is connected to one of the analyzers' TRIGGER INPUT connector. A trigger signal is generated when you press (release) the "TRIG MANUAL" button on the trigger unit.
Note: in Manual mode you have to make sure the NOISE SOURCE CONTROL INPUT on the trigger unit remains open, that is: not connected.

A trigger unit is activated in the [General Settings](#).

For more detailed information on the R&S®FS-Z11 Trigger Unit and the required connections, see the "R&S®FS-Z11 Trigger Unit Manual".

Connecting the R&S®FS-Z11 Trigger Unit

Connect the trigger unit with your measurement setup according to the following schematic diagram:

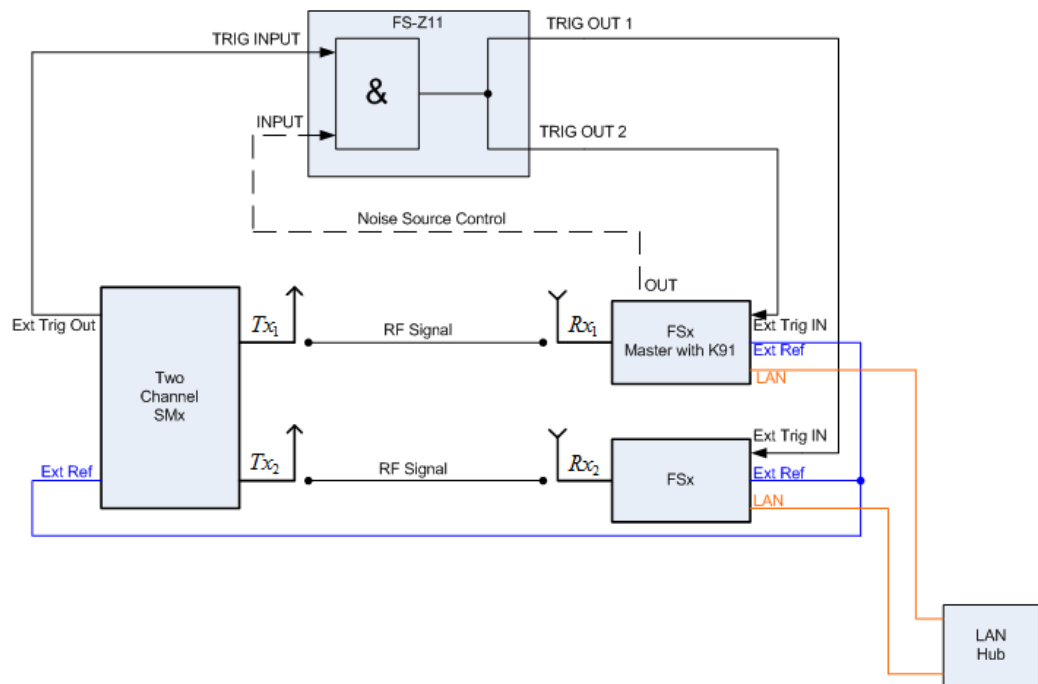

Fig. 3-6: R&S@FS-Z11 Trigger Unit connections

1. Connect the EXT TRIG inputs of all analyzers (master and slaves) to the TRIG OUT 1 to 4 (or 1 and 2 only for measurements on two Tx antennas) of the trigger unit.
The order is irrelevant, that means you could also connect the master analyzer to the TRIG OUT 2 output of the trigger unit, for example.
2. If necessary for the required operating mode (see above), connect the NOISE SOURCE output of the master analyzer to the NOISE SOURCE CONTROL INPUT of the trigger unit.

3.7 Signal Field Measurement (IEEE 802.11ac, n (SISO +MIMO))

For the IEEE 802.11 ac, n (SISO+MIMO) standards, an enhanced Signal Field measurement is available, with an improved result display and additional information.

For each analyzed PPDU of the signal, the Signal Field measurement contains the HT-SIG₁ and HT-SIG₂ as a bit sequence. Where appropriate this information is also provided in human-readable form beneath the bits.

The list header contains the following information:

- The first line indicates the HT-SIG field assigned to the corresponding bit sequence (See IEEE Std 802.11n-2009 Figure 20-6—Format of HT-SIG1 and HT-SIG2).

Signal Field Measurement (IEEE 802.11ac, n (SISO+MIMO))

- The second line shows the R&S FSV-K91 parameters affecting which PPDU take part in the analysis and which do not (this functionality is referred as "logical filter").
- The value inside the white rectangle indicates the current "logical filter" setting.

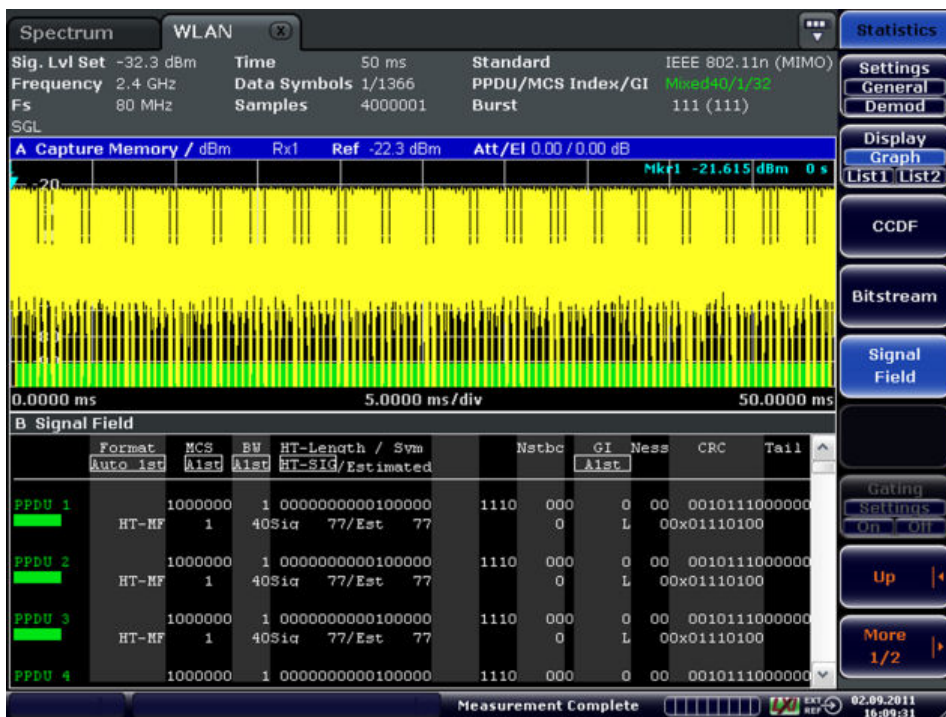

Fig. 3-7: FSV-K91 Enhanced Signal Field measurement

Measurement settings

The settings for this measurement are defined in the "Demod Settings" for the IEEE 802.n standard, and in the "Advanced Demod Settings" for the IEEE 802.n (MIMO) standard.

Note that for the IEEE 802.n standard, the "Use Signal Field Content" setting must be activated for Signal Field measurements.

The following table indicates which PPDU properties are displayed in the result table of the Signal Field measurement and which R&S FSV-K91 settings are used to obtain these properties.

PPDU Property	Setting for IEEE 802.n	Setting for IEEE 802.n (MIMO)
Format	PPDU Frame Format	Burst type to measure
MCS	Auto Demod ON: Auto, same type as first burst Auto Demod OFF: PSDU Mod to Analyze	MCS Index to use
Bandwidth	PPDU Frame Format	Channel BW to measure
HT Length	Source of Payload Len	Source of Payload Len
GI	Guard Interval	Guard Interval Len

Signal Field Measurement (IEEE 802.11ac, n (SISO+MIMO))

Measurement results

The R&S FSV-K91 determines certain inconsistencies in the signal and informs the user with an appropriate warning. If the signal was analyzed successfully the results – indicated by a message - also contribute to the overall analysis results. The corresponding PPDU in the Capture Memory is highlighted by an orange bar.

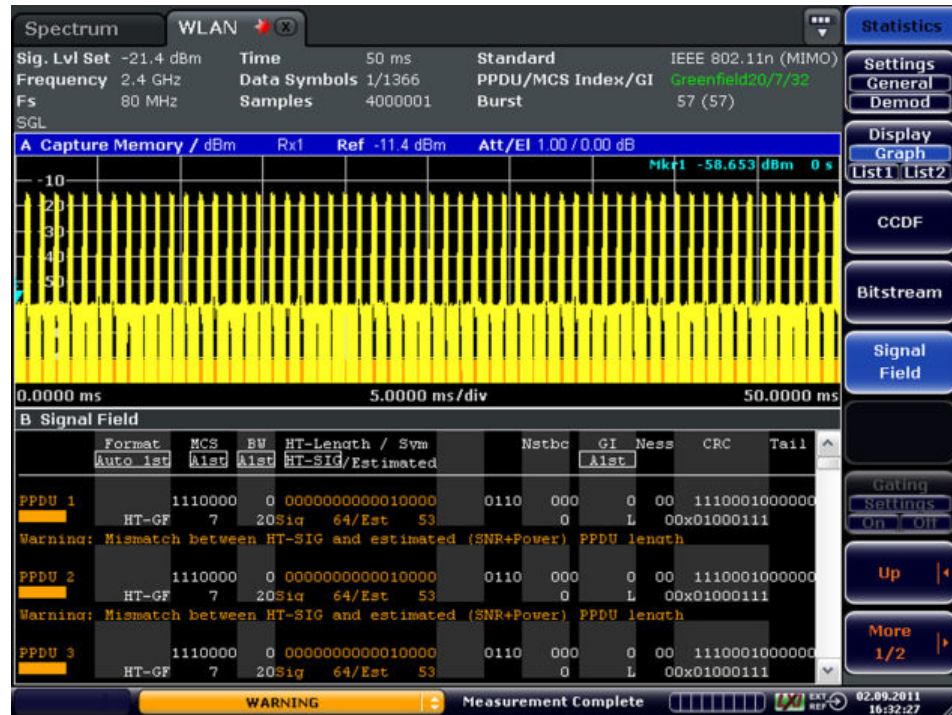

Fig. 3-8: The Signal Field measurement revealing a length conflict between the HT-SIG length and the length estimated from the PPDU power profile

If a required property set by the user in the Demod Settings does not match the corresponding PPDU property from the list, the PPDU is dismissed. An appropriate message is provided. The corresponding PPDU in the Capture Memory is not highlighted.

Signal Field Measurement (IEEE 802.11ac, n (SISO+MIMO))

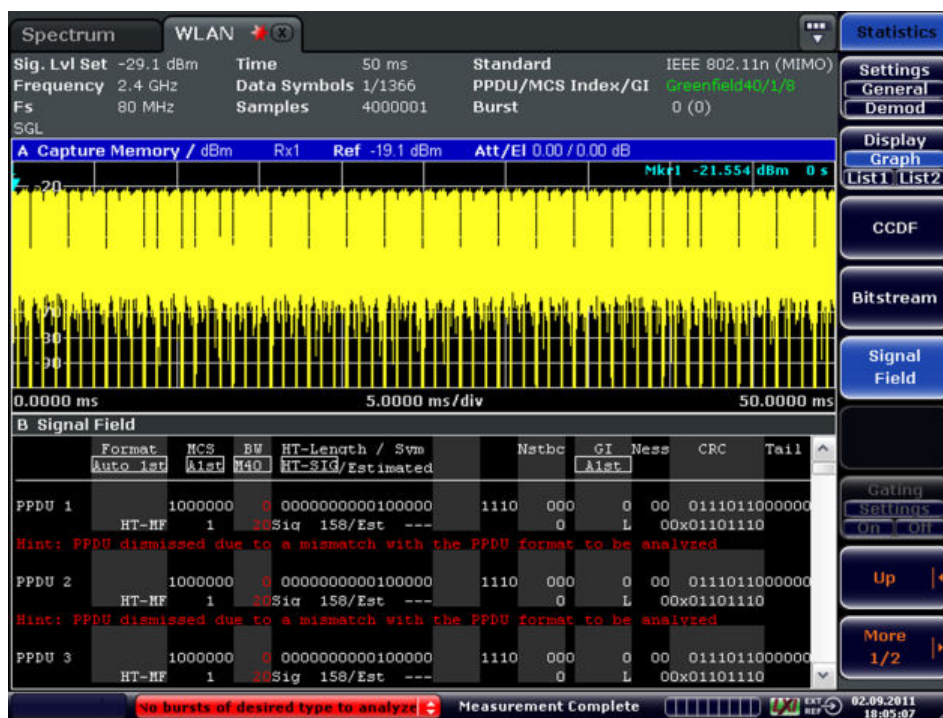

Fig. 3-9: Mixed mode 20MHz signal with "Channel BW to measure" set to measure only 40MHz signals

Messages and warnings

The following messages are generated by the R&S FSV-K91 measurement application:

Results contribute to overall results despite inconsistencies:

"Info: Comparison between HT-SIG Payload Length and Estimated Payload Length not performed due to insufficient SNR"

The R&S FSV-K91 application compares the HT-SIG length against the length estimated from the PPDU power profile. If the two values do not match, the corresponding entry is highlighted orange. If the signal quality is very bad, this comparison is suppressed and the message above is shown.

"Warning: HT-SIG of PPDU was not evaluated"

Decoding of the HT-SIG was not possible because there was not enough data in the Capture Memory (potential burst truncation).

"Warning: Mismatch between HT-SIG and estimated (SNR+Power) PPDU length"

The HT-SIG length and the length estimated by the R&S FSV application (from the PPDU power profile) are different.

"Warning: Physical Channel estimation impossible / Phy Chan results not available Possible reasons: channel matrix not square or singular to working precision"

The Physical Channel results could not be calculated for one or both of the following reasons:

- The spatial mapping can not be applied due to a rectangular mapping matrix (the number of space time streams is not equal to the number of transmit antennas).
- The spatial mapping matrices are singular to working precision.

PPDUs are dismissed due to inconsistencies

"Hint: PPDU requires at least one payload symbol"

Currently at least one payload symbol is required in order to successfully analyze the PPDU. Null data packet (NDP) sounding bursts will generate this message.

"Hint: PPDU dismissed due to a mismatch with the PPDU format to be analyzed"

The properties causing the mismatches for this PPDU are highlighted.

"Hint: PPDU dismissed due to truncation"

The first or the last burst was truncated during the signal capture process, for example.

"Hint: PPDU dismissed due to HT-SIG inconsistencies"

One or more of the following HT-SIG decoding results are outside of specified range: MCS index, Number of additional STBC streams, Number of space time streams (derived from MCS and STBC), CRC Check failed, Non zero tail bits.

"Hint: PPDU dismissed because payload channel estimation was not possible"

The payload based channel estimation was not possible because the channel matrix is singular to working precision.

"Hint: Channel matrix singular to working precision"

Channel equalizing (for Burst Length Detection, fully and user compensated measurement signal) is not possible because the estimated channel matrix is singular to working precision.

3.8 Measurement Result Types

3.8.1 IQ Impairments

This chapter provides an overview over the I/Q impairments for the R&S FSV-K91/91n.

- [chapter 3.8.1.1, "IQ Offset"](#), on page 44
- [chapter 3.8.1.2, "Gain Imbalance"](#), on page 44
- [chapter 3.8.1.3, "Quadrature Error"](#), on page 46

3.8.1.1 IQ Offset

An IQ-Offset indicates a carrier offset with fixed amplitude. This results in a constant shift of the IQ axes. The offset is normalized by the mean symbol power and displayed in dB.

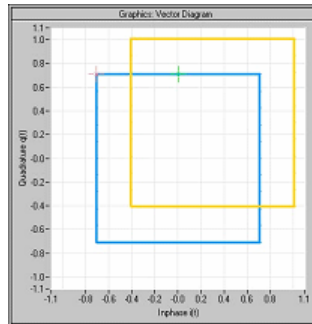

3.8.1.2 Gain Imbalance

An ideal I/Q modulator amplifies the I and Q signal path by exactly the same degree. The imbalance corresponds to the difference in amplification of the I and Q channel and therefore to the difference in amplitude of the signal components. In the vector diagram, the length of the I vector changes relative to the length of the Q vector.

The entry is displayed in dB and %, where 1 dB offset is roughly 12 % according to the following:

$$\text{Imbalance [dB]} = 20 \log (| \text{GainQ} | / | \text{GainI} |)$$

Positive values mean that the Q vector is amplified more than the I vector by the corresponding percentage:

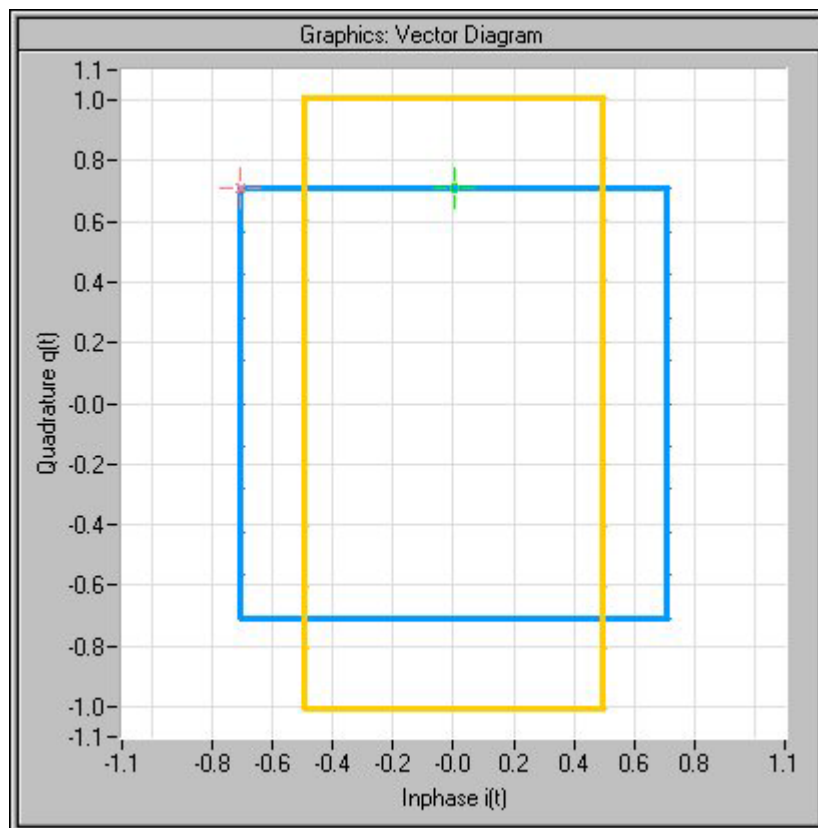

Negative values mean that the I vector is amplified more than the Q vector by the corresponding percentage:

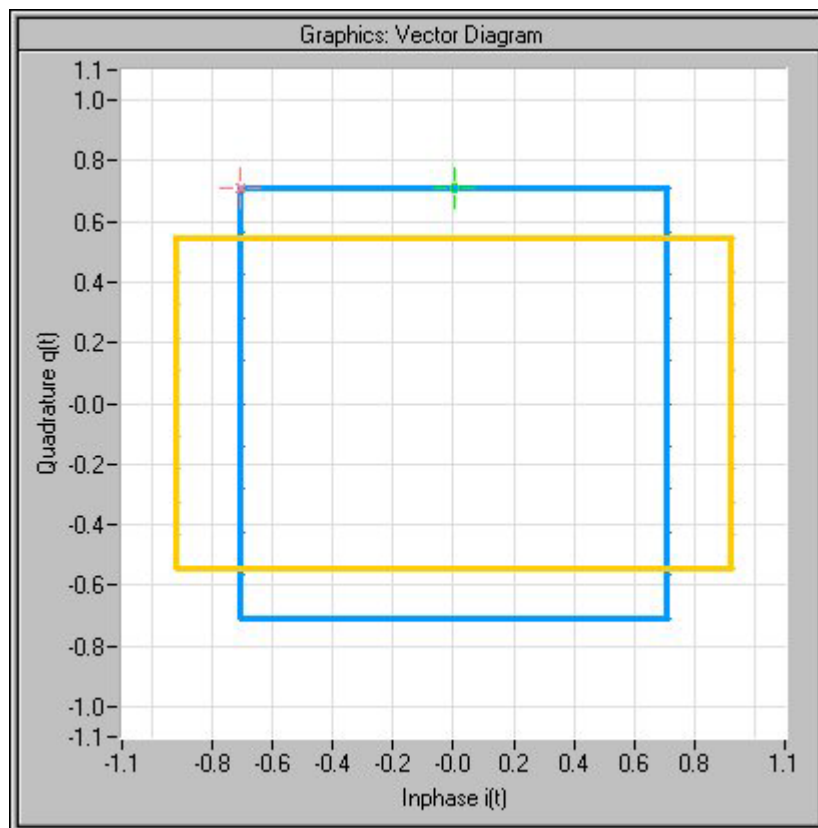

3.8.1.3 Quadrature Error

An ideal I/Q modulator sets the phase angle to exactly 90 degrees. With a quadrature error, the phase angle between the I and Q vector deviates from the ideal 90 degrees, the amplitudes of both components are of the same size. In the vector diagram, the quadrature error causes the coordinate system to shift.

A positive quadrature error means a phase angle greater than 90 degrees:

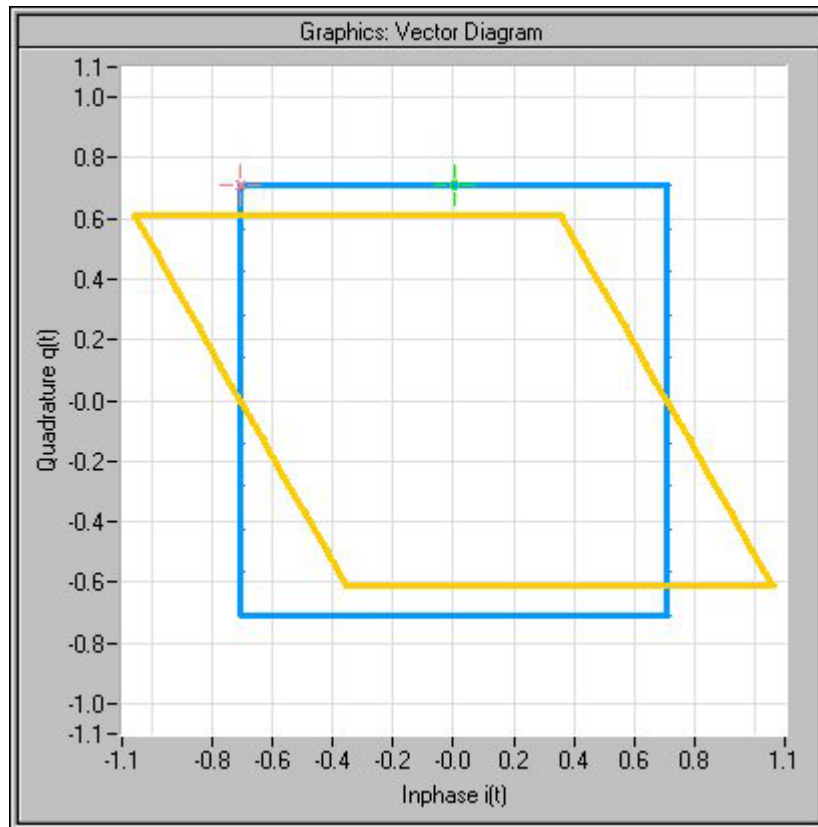

A negative quadrature error means a phase angle less than 90 degrees:

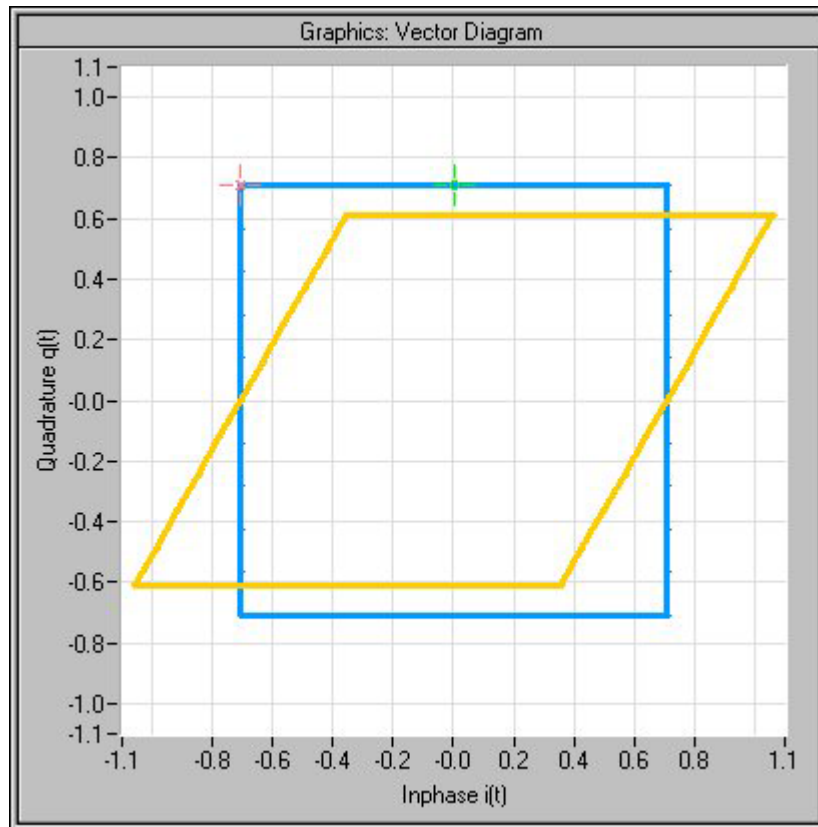

3.8.2 EVM Measurement

The R&S FSV-K91 option provides two different types of EVM calculation.

Peak EVM (IEEE)

Peak EVM (IEEE) evaluates the EVM as defined in section 18.4.7.8 "Transmit modulation accuracy" of the IEEE 802.11b standard. The measurement signal is corrected in respect of frequency error and clock deviation before EVM calculation. Additionally the specified calculation removes the dc offset of the measurement signal.

The standard does not specify a normalization factor for the error vector magnitude. To get a level independent EVM value, the R&S FSV-K91 normalizes the EVM values, so that an EVM of 100% indicates that the error power on the I- or Q-channels equals the mean power on the I- or Q-channels respectively.

The Peak EVM is the maximum EVM over all chips of one burst. If more than one burst is evaluated (several analyzed bursts in the capture buffer or with the help of Overall Burst Count), the Min / Mean / Max columns show the minimum, mean or maximum Peak EVM of all analyzed bursts.

The IEEE 802.11b standard allows a Peak EVM of less than 35%. In contrary to the specification, the R&S FSV-K91 does not limit the measurement to 1000 chips length, but searches the maximum over the whole burst.

Burst EVM (Direct)

Burst EVM (Direct) evaluates the root mean square EVM over one burst. That is the square root of the averaged error power normalized by the averaged reference power:

$$\text{EVM} = \sqrt{\frac{\sum_{n=0}^{N-1} |x_{\text{meas}}(n) - x_{\text{ref}}(n)|^2}{\sum_{n=0}^{N-1} |x_{\text{ref}}(n)|^2}} = \sqrt{\frac{\sum_{n=0}^{N-1} |e(n)|^2}{\sum_{n=0}^{N-1} |x_{\text{ref}}(n)|^2}}$$

Before calculation of the EVM, the measurement signal is corrected in respect of frequency error, clock deviation and IQ impairments.

If more than one burst is evaluated (several analyzed bursts in the capture buffer or with the help of Overall Burst Count), the Min / Mean / Max columns show the minimum, mean or maximum Burst EVM of all analyzed bursts.

Burst EVM is not part of the IEEE standard and no limit check is specified. Nevertheless, this commonly used EVM calculation can give some insight in modulation quality and allows comparisons to other modulation standards.

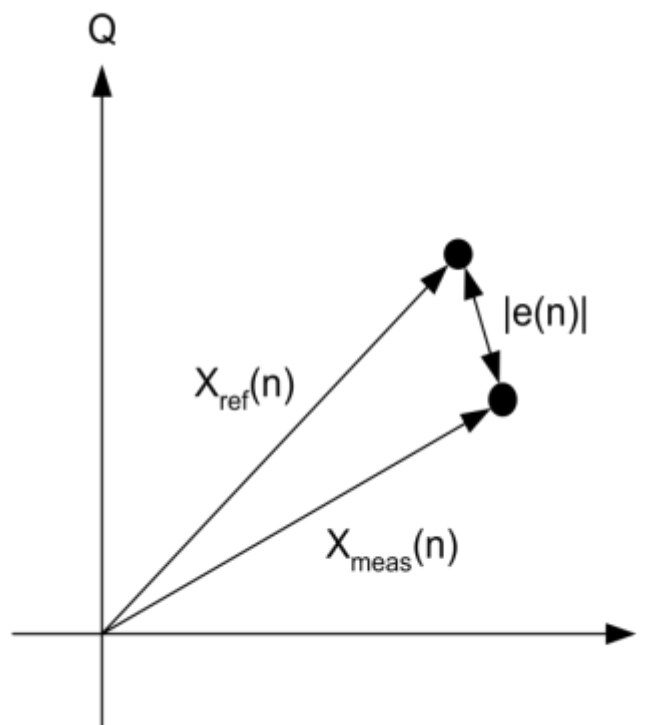

Fig. 3-10: IQ diagram for EVM calculation

3.8.3 Rise/Fall Time Measurement

The rise/fall time is calculated according to the following algorithm:

- Apply a moving average filter over the burst power (adjustable average length)
- If "Ref Pow Max" is set: Search maximum power P_{max} over the whole burst. Set $P_{ref}=P_{max}$
- If "Ref Pow Mean" is set: Calculate mean power P_{mean} of the whole burst. Set $P_{ref}=P_{mean}$
- Rise time
 - Search the first crossing of $0.5 \times P_{ref}$ from the left.
 - Search backwards for the 10 % crossing $0.1 \times P_{ref}$ and note t_{10} .
 - Search forward for the 90 % crossing $0.9 \times P_{ref}$ and note t_{90} .
 - Return $T_{rise}=t_{90}-t_{10}$.
- Fall time
 - Search the first crossing of $0.5 \times P_{ref}$ from the right.
 - Search forwards for the 10 % crossing $0.1 \times P_{ref}$ and note t_{10} .
 - Search backwards for the 90 % crossing $0.9 \times P_{ref}$ and note t_{90} .
 - Return $T_{fall}=t_{10}-t_{90}$.

Since the single carrier modes of 802.11b, g use linear modulation formats like BPSK or QPSK, the transmit signal power varies between symbol sampling times. These power variations are determined by the transmit filter, which is not defined in the standard. The R&S FSV-K91/91n allows fine tuning of the PVT measurements on signals with high crest factors by an adjustable moving average filter and two different reference power settings.

The reference power equals the 100 % setting for the rise/fall time calculation. Either the maximum burst power or the mean burst power can be chosen as reference power. Using the mean burst power, rarely power peaks within the burst does not influence the rise/fall time measurement.

The moving average filter smoothes the power trace and thus eliminates the modulation. While a long average length leads to more stable measurement results, it naturally increases the rise/fall times compared to no averaging.

3.9 Measurement Settings and Result Displays

The WLAN option provides two main measurement types:

Frequency sweep measurements

- Spectrum mask (see ["Spectrum Mask \(IEEE 802.11ac, b, g \(Single Carrier\)\) / Spectrum IEEE/ETSI \(IEEE 802.11a, g, j, n \(OFDM\), p\)"](#) on page 78 softkey)
- Spectrum ACP/ACPR (see ["Spectrum ACPR \(IEEE 802.11a, ac, g \(OFDM Turbo Mode\), n, p\) / Spectrum ACP \(IEEE 802.11b\) / ACP Rel/Abs \(IEEE 802.11j\)"](#) on page 80)

I/Q measurements (based on captured IQ data)

- Power vs Time (see "PVT" on page 64)
- EVM vs Symbol, EVM vs Carrier (see "EVM vs Symbol/Carrier" on page 69 softkey)
- Phase vs Preamble, Frequency vs Preamble (see "Error Frequency/Phase" on page 71 softkey)
- Spectrum Flatness (see "Spectrum Flatness (IEEE 802.11a, ac, g, j, n (OFDM), p / Group Delay (IEEE 802.11 n (MIMO))" on page 76 softkey)
- Spectrum FFT (see "Spectrum FFT" on page 79 softkey)
- Constellation vs Symbol, Constellation vs Carrier (see "Constell vs Symbol/Carrier" on page 73 softkey)
- Conditional Cumulative Distribution Function (see "CCDF" on page 83 softkey)
- Bit Stream (see "Bitstream" on page 83 softkey)
- Signal Field (see "Signal Field (IEEE 802.11a, ac, g (OFDM), j , n, p)" on page 85 softkey)

When using the IEEE 802.11n standard, I/Q measurements are available both in SISO mode (one antenna, one data stream), and MIMO mode (several antennas, several data streams). For details see [chapter 3.6, "IEEE 802.11n/ac MIMO Measurements"](#), on page 36.

Measurement result display

The measurement result display is divided into two panes:

- [chapter 3.9.1, "Measurement Settings"](#), on page 51
- Result displays

The results can be displayed in form of a list or a graph (see also "Display List/Graph" on page 64 softkey).

- [chapter 3.9.2, "Result Summary List"](#), on page 54
- [chapter 3.9.3, "Result Display Graph"](#), on page 59

Saving results

The measurement results can be stored at any time using the SAVE/RCL key (see the base unit description). Both the measured I/Q data and the trace and table results can be stored individually. Furthermore, any limit values modified in the result summary can also be stored. Note that for trace and table results, the originally measured values are always stored. The values are not updated after changes to the Demod Settings. I/Q data, on the other hand, can be refreshed before it is stored.

3.9.1 Measurement Settings

The overall measurement settings used to obtain the current measurement results are displayed in the channel bar:

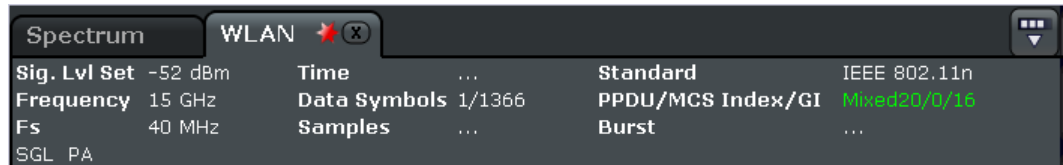

Fig. 3-11: Measurement settings in the channel bar (example)

The following settings are listed:

Table 3-1: Measurement settings for IEEE 802.11a, p

Setting	Description	Restrictions
Sig. Lvl. Set	The expected mean signal level for the input signal.	Turbo Mode only
Frequency	The frequency of the measured input signal.	
Time		
Data Symbols	Shows the minimum and maximum number of data symbols that a burst may have if it is to be considered in results analysis.	Turbo Mode only
Samples		
Standard	Selected measurement standard	
Burst Type	The type of burst being analyzed.	
Modulation	Shows the active setting selected in the "Demod Settings" dialog box: "Demodulator" or "PSDU Modulation to Analyze".	Turbo Mode only
Burst x of y (z)	In case statistic over bursts is switched on (Overall Burst Count), x bursts of totally required y (No of Bursts to Analyze) bursts have been analyzed so far. The value z gives the number of analyzed bursts by the last update of the statistic.	

Table 3-2: Measurement settings for IEEE 802.11b+g

Setting	Description	Restrictions
Ext Att	The attenuation (positive values) or gain (negative values) applied to the signal externally (i.e. before the RF or IQ connector of the signal analyzer), e.g.: External Att = 10 dB means that before the RF connector of the R&S FSV a 10 dB attenuator is used External Att = -20 dB means that before the RF connector of the R&S FSV an amplifier with 20 dB gain is used	
Frequency	The frequency of the measured input signal.	
Cap Time	The spectrum analyzer samples the signal for this time interval length.	
PSDU Length	Shows the minimum and maximum number of data bytes that a burst may have if it is to be considered in results analysis.	
Samples		

Setting	Description	Restrictions
Standard	Selected measurement standard	
Preamble	The type of preamble of analyzed bursts.	Single Carrier only
Modulation	Shows the active setting selected in the "Demod Settings" dialog box: "Demodulator" or "PSDU Modulation to Analyze".	
Burst x of y (z)	In case statistic over bursts is switched on (Overall Burst Count), x bursts of totally required y (No of Bursts to Analyze) bursts have been analyzed so far. The value z gives the number of analyzed bursts by the last update of the statistic.	

Table 3-3: Measurement settings for IEEE 802.11j

Setting	Description	Restrictions
Sig Lvl Set	The expected mean signal level for the input signal.	Turbo Mode only
Frequency	The frequency of the measured input signal.	
Time		
Data Symbols	Shows the minimum and maximum number of data symbols that a burst may have if it is to be considered in results analysis.	Turbo Mode only
Samples		
Standard	Selected measurement standard	
Burst Type	The type of burst being analyzed.	Turbo Mode only
Modulation	Shows the active setting selected in the "Demod Settings" dialog box: "Demodulator" or "PSDU Modulation to Analyze".	
Burst x of y (z)	In case statistic over bursts is switched on (Overall Burst Count), x bursts of totally required y (No of Bursts to Analyze) bursts have been analyzed so far. The value z gives the number of analyzed bursts by the last update of the statistic.	

Table 3-4: Measurement settings for IEEE 802.11ac, n (SISO+MIMO)

Setting	Description	Restrictions
Sig Lvl Set	The expected mean signal level for the input signal.	Turbo Mode only
Frequency	The frequency of the measured input signal.	
Fs	Input sample rate	
Time		
Data Symbols	Shows the minimum and maximum number of data symbols that a burst may have if it is to be considered in results analysis.	Turbo Mode only
Samples	Number of samples for the "Capture Time" interval generated at Input Sample Rate "Fs".	SISO only

Setting	Description	Restrictions
Standard	Selected measurement standard	
PPDU/MCS Index/GI	The PPDU Type, MCS Index and Guard Interval used for the analysis of the signal is displayed. Depending on the Demod Settings, these values are either automatically detected from the signal or the user settings are applied.	
Burst x of y (z)	In case statistic over bursts is switched on (Overall Burst Count), x bursts of totally required y (No of Bursts to Analyze) bursts have been analyzed so far. The value z gives the number of analyzed bursts by the last update of the statistic.	

3.9.2 Result Summary List

The result summary list shows the overall measurement results and provides limit checking for result values in accordance with the selected standard. Result values which are within the limit as specified by the standard are displayed in green. Result values which are outside of the limits specified by the standard are displayed in red with a "*" to the left. Results which have no limits specified by the standard are displayed in white. Limit values are displayed in white (not bold) and can be modified, if focused, via the keypad. To reset the limit values to the values specified in the standard, use the "Lines" menu ([chapter 4.8, "Softkeys of the Lines Menu – LINES key"](#), on page 113).

The results displayed in this list are for the entire measurement. If a specific number of bursts have been requested which requires more than one sweep, the result summary list is updated at the end of each sweep. The number of bursts measured and the number of bursts requested are displayed to show the progress through the measurement. The Min/Mean/Max columns show the minimum, mean or maximum values of the burst results.

For details on the displayed measurement results see [chapter 3.8, "Measurement Result Types"](#), on page 43.

3.9.2.1 Result display for measurements on OFDM signals



Fig. 3-12: Result summary list for measurements on OFDM signals

- EVM All Carr, IEEE802.11a, j, g, p**
 Shows the EVM (Error Vector Magnitude) over all carriers of the payload symbols in % and in dB. For better orientation, the table also shows the corresponding limits specified in the standard.
- EVM Data Carr, IEEE802.11a, j, g, p**
 Shows the EVM (Error Vector Magnitude) over all data carriers of the payload symbols in % and in dB. For better orientation, the table also shows the corresponding limits specified in the standard.
- EVM Pilot Carr, IEEE802.11a, j, g, p**
 Shows the EVM (Error Vector Magnitude) over all pilot carriers of the payload symbols in % and in dB. For better orientation, the table also shows the corresponding limits specified in the standard.
- IQ Offset, IEEE802.11a, j, g, p**
 Shows the IQ offset of the signal in dB. This is the transmitter center frequency leakage relative to overall transmitted power. For better orientation, the table also shows the corresponding limits specified in the standard.
- Gain Imbalance, IEEE802.11a, j, g, p**

Shows the gain imbalance of the signal in % as well as dB. This is the amplification of the quadrature phase component of the signal relative to the in-phase component.

- **Quadrature Error, IEEE802.11a, j, g, p**

Shows the quadrature error of the signal in degree. This is the deviation of the quadrature phase angle from the ideal 90°.

- **Frequency Error, IEEE802.11a, j, g, p**

Shows the frequency error between the signal and the current center frequency of the R&S analyzer. The absolute frequency error is the sum of the frequency error of the R&S analyzer and that of the DUT. If possible, the transmitter and the receiver should be synchronized.

For better orientation, the table also shows the corresponding limits specified in the standard.

- **Symbol Clock Error, IEEE802.11a, j, g, p**

Shows the clock error between the signal and the sample clock of the R&S analyzer in parts per million (ppm). For better orientation, the table also shows the corresponding limits specified in the standard.

- **Burst Power, IEEE802.11a, j, g, p**

Shows the mean burst power in dBm.

- **Crest Factor, IEEE802.11a, j, g, p**

Shows the crest factor in dB. The crest factor is the ratio of the peak power to the mean power of the signal (also called Peak to Average Power Ratio, PAPR).

3.9.2.2 Result display for measurements on DSSS / CCK / PBCC signals



Fig. 3-13: Result summary list for measurements on DSSS/CCK/PBCC signals

- Peak Vector Err, IEEE802.11b, g**
 Shows the peak vector error over the complete burst including the preamble in % and in dB. The vector error is calculated according to the IEEE 802.11b definition of the normalized error vector magnitude. For better orientation, the table also shows the corresponding limits specified in the standard.
- Burst EVM, IEEE802.11b, g**
 Shows the EVM (Error Vector Magnitude) over the complete burst including the preamble in % and dB.
- IQ Offset**
 Shows the IQ offset of the signal in dB. This is the IQ offset magnitude relative to the RMS magnitude at the chip timing.
- Gain Imbalance**
 see [chapter 3.9.2.1, "Result display for measurements on OFDM signals"](#), on page 55
- Quadrature Error**
 see [chapter 3.9.2.1, "Result display for measurements on OFDM signals"](#), on page 55
- Center Frequency Error**

see [chapter 3.9.2.1, "Result display for measurements on OFDM signals"](#), on page 55

- **Chip Clock Error, IEEE802.11b, g**
see Symbol Clock Error in [chapter 3.9.2.1, "Result display for measurements on OFDM signals"](#), on page 55
- **Rise Time, IEEE802.11b, g**
Shows the rise time of the pulsed signal in μs . This is the time period the signal needs to increase its power level from 10% to 90% of the maximum resp. the average power depending on the reference power setting. For better orientation, the table also shows the corresponding limits specified in the standard.
- **Fall Time, IEEE802.11b, g**
Shows the fall time of the pulsed signal in μs . This is the time period the signal needs to decrease its power level from 90% to 10% of the maximum resp. the average power depending on the reference power setting. For better orientation, the table also shows the corresponding limits specified in the standard.
- **Mean Power, IEEE802.11b, g**
Shows the mean burst power in dBm.
- **Peak Power, IEEE802.11b, g**
Shows the maximum burst power in dBm.
- **Crest Factor**
- **Rise Time, IEEE802.11b, g**
Shows the rise time of the pulsed signal in μs . This is the time period the signal needs to increase its power level from 10% to 90% of the maximum resp. the average power depending on the reference power setting. For better orientation, the table also shows the corresponding limits specified in the standard.

All parameters and their calculations are described in detail in chapter 1 of this manual, 'Advanced Measurement Examples'

3.9.2.3 Result Display for MIMO Measurements

For MIMO measurements (IEEE 802.11ac or n (MIMO) only) the results are provided as an overview of all data streams in the Global Result Summary (List 1), and for the individual streams in separate result summaries (List 2). To switch between the two views, use the "Display Graph/List1/List2" softkey. To view more details for the individual summaries, select the table and then press the "Split Screen/Maximize Screen" key ().

Global Result Summary						
Recognised Bursts	5					
Analyzed Bursts	5					
Analyzed Bursts Phy Chan	5					
	Min	Mean	Limit	Max	Limit	Unit
EVM All Carriers	0.40	0.40	7.94	0.41	7.94	%
	-48.00	-47.86	-22.00	-47.74	-22.00	dB
EVM Data Carriers	0.40	0.40	7.94	0.41	7.94	%
	-47.98	-47.86	-22.00	-47.73	-22.00	dB
EVM Pilot Carriers	0.38	0.41	56.23	0.43	56.23	%
	-48.41	-47.78	-5.00	-47.26	-5.00	dB
Center Frequency Error	-2.27	-4.77	± 60000	-6.94	± 60000	Hz
Symbol Clock Error	1.11	1.57	± 25	1.82	± 25	ppm

Fig. 3-14: MIMO Global result summary

A:Result Summary						
	Rx1	Tx1	Unit		Stream1	Unit
IQ offset	-	-69.31	dB	BER Pilot	0.00	%
Gain Imbalance	-	-0.01	dB	EVM All Carrier	-47.80	dB
Burst Power	-11.44	-	dBm	EVM Data Carrie	-47.81	dB
Crest Factor	10.91	-	dB	EVM Pilot Carrier	-47.63	dB
B:Result Summary						
	Rx2	Tx2	Unit		Stream2	Unit
IQ offset	-	-75.93	dB	BER Pilot	0.00	%
Gain Imbalance	-	-0.01	dB	EVM All Carrier	-47.91	dB
Burst Power	-11.47	-	dBm	EVM Data Carrie	-47.91	dB
Crest Factor	10.79	-	dB	EVM Pilot Carrier	-47.93	dB

Fig. 3-15: MIMO result summary: overview of 2 streams

3.9.3 Result Display Graph

Additionally to the selected graphical result display, the Magnitude Capture Buffer display is provided for all I/Q measurements. The individual result displays are described with the corresponding softkey.

The Magnitude Capture Buffer display shows the complete range of captured data for the last sweep. All analyzed bursts are identified with a green bar at the bottom of the Magnitude Capture Buffer display. If, in the "Demod Settings" dialog box, the "Signal Field Content" option is activated, only bursts that match the required criteria are marked with a green bar (see "Signal Field Content (IEEE 802.11a, g (OFDM), j & n (SISO), p)" on page 98).

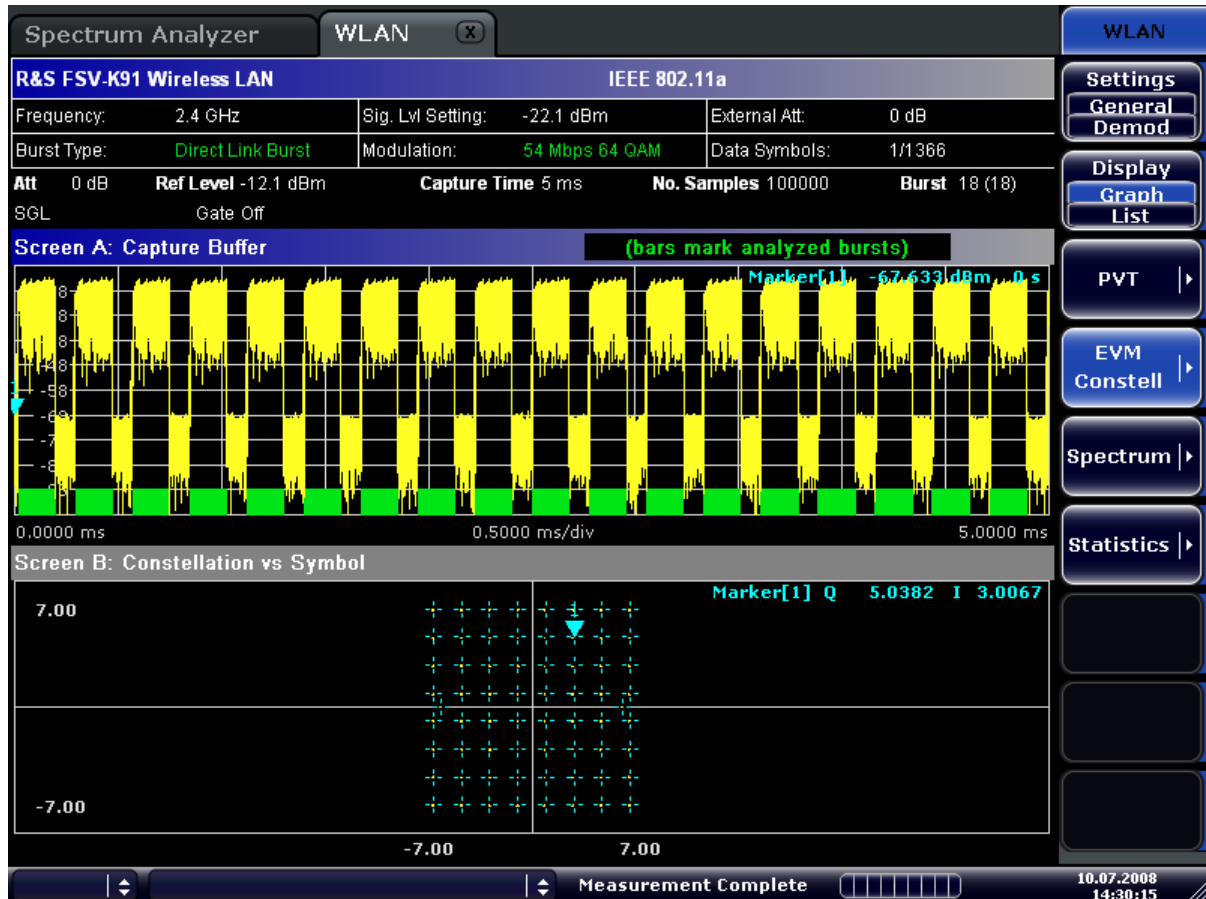

Fig. 3-16: Magnitude capture buffer results (example)

- I/Q measurements
All I/Q measurements process the same signal data and as such all I/Q measurement results are available after a single I/Q measurement execution. I/Q measurements can be run in split screen mode (allowing both the Magnitude Capture Buffer display and the selected I/Q measurement results to be displayed simultaneously) or in full screen mode (with either the Magnitude Capture Buffer display or the selected I/Q measurement results displayed).
- Frequency sweep measurements
The frequency sweep measurements use different signal data to I/Q measurements and as such it is not possible to run an I/Q measurement and then view the results in the frequency sweep measurements and vice-versa. Also because each of the frequency sweep measurements uses different settings to obtain signal data it is not possible to run a frequency sweep measurement and view the results of another frequency sweep measurement. All frequency sweep measurements are run in full screen mode.

- For MIMO measurements (IEEE 802.11ac or n (MIMO) only) the results for each data stream are displayed in a separate graph.

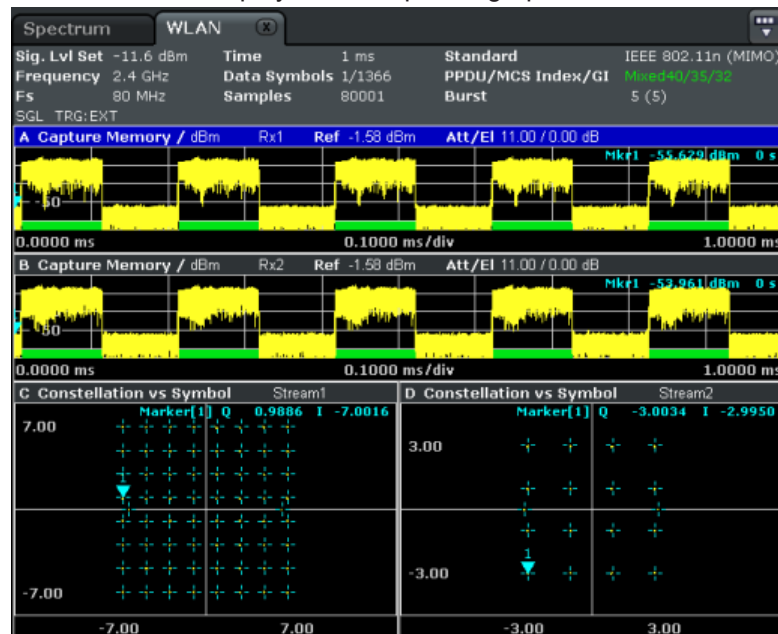

Fig. 3-17: MIMO data stream results (example)

3.9.4 Title Bar Information

The title bar displays the following information:

- wireless LAN standard applicable to the current measurement.

3.9.5 Status Bar Information

- The status bar displays the same information as the base device (see the "Quick Start Guide").

4 Instrument Functions WLAN TX Measurements

To open the WLAN menu

- If the "WLAN" mode is not the active measurement mode, press the MODE key and select the "WLAN" softkey

To exit the "WLAN" measurement mode, select another option.

Menu and softkey description

- [chapter 4.1, "Softkeys of the WLAN TX Menu"](#), on page 63
- [chapter 4.4, "Softkeys of the Sweep Menu – SWEEP key"](#), on page 110
- [chapter 4.6, "Softkeys of the Marker Menu – MKR key \(WLAN\)"](#), on page 111
- [chapter 4.7, "Softkeys of the Marker To Menu – MKR-> key"](#), on page 112
- [chapter 4.8, "Softkeys of the Lines Menu – LINES key"](#), on page 113
- [chapter 4.5, "Softkeys of the Trace Menu – TRAC key"](#), on page 111
- [chapter 4.9, "Softkeys of the Input/Output Menu for WLAN Measurements"](#), on page 113

The "Span", "Bandwidth", "Marker Function", and "Auto Set" menus are not available in the WLAN mode.

The FREQ, AMPT, and TRIG keys open the "General Settings" or the "Demod Settings" dialog box. For details refer to the ["Settings General/Demod"](#) on page 64 softkey description ("WLAN" menu).

To display help to a softkey, press the HELP key and then the softkey for which you want to display help. To close the help window, press the ESC key. For further information refer to [chapter 1.3, "How to Use the Help System"](#), on page 8.

Further information

This chapter provides further information about the measurements and result displays for the WLAN application.

4.1	Softkeys of the WLAN TX Menu	63
4.2	General Settings Dialog Box (K91)	87
4.2.1	General Settings.....	88
4.2.2	Advanced Settings.....	92
4.2.3	STC/MIMO Settings (IEEE 802.11ac, n (MIMO) only).....	93
4.3	Demod Settings Dialog Box	97
4.3.1	Demod Settings.....	97
4.3.2	Advanced Demod Settings (IEEE 802.11ac, n (MIMO) only).....	104
4.3.3	MIMO Settings (IEEE 802.11ac, n (MIMO) only).....	109

4.4	Softkeys of the Sweep Menu – SWEEP key	110
4.5	Softkeys of the Trace Menu – TRAC key.....	111
4.6	Softkeys of the Marker Menu – MKR key (WLAN).....	111
4.7	Softkeys of the Marker To Menu – MKR-> key.....	112
4.8	Softkeys of the Lines Menu – LINES key.....	113
4.9	Softkeys of the Input/Output Menu for WLAN Measurements.....	113

4.1 Softkeys of the WLAN TX Menu

The following table shows all softkeys available in the "WLAN" menu. It is possible that your instrument configuration does not provide all softkeys. If a softkey is only available with a special option, model or (measurement) mode, this information is delivered in the corresponding softkey description.

Settings General/Demod.....	64
Display List/Graph.....	64
PVT.....	64
L Full Burst.....	65
L Rising & Falling.....	65
L Ramp Up/Down/Up & Down (IEEE 802.11b, g – Single Carrier).....	66
L Ref Pow Max/Mean (IEEE 802.11b, g – Single Carrier).....	67
L Average Length (IEEE 802.11b, g – Single Carrier).....	67
L Gating Settings On/Off ((IEEE 802.11a, b, g, j, p).....	67
L Import.....	68
L Export.....	68
L R&S Support.....	69
EVM Constell.....	69
L Settings General/Demod.....	69
L Display List/Graph.....	69
L EVM vs Symbol/Carrier.....	69
L Error Frequency/Phase.....	71
L Constell vs Symbol/Carrier.....	73
L Carrier Selection (IEEE 802.11a, ac, g, j, n (OFDM), p).....	75
L Gating Settings On/Off.....	75
L Import.....	75
L Export.....	75
L Y-Axis/Div.....	75
L R&S Support.....	76
Spectrum.....	76
L Settings General/Demod.....	76
L Display List/Graph.....	76
L Spectrum Flatness (IEEE 802.11a, ac, g, j, n (OFDM), p / Group Delay (IEEE 802.11 n (MIMO)).....	76
L Spectrum Mask (IEEE 802.11ac, b, g (Single Carrier)) / Spectrum IEEE/ETSI (IEEE 802.11a, g, j, n (OFDM), p).....	78
L Spectrum FFT.....	79

L Spectrum ACPR (IEEE 802.11a, ac, g (OFDM Turbo Mode), n, p)/ Spectrum ACP (IEEE 802.11b)/ ACP Rel/Abs (IEEE 802.11j).....	80
L Gating Settings On/Off.....	81
L SEM Settings.....	81
L SEM according to.....	81
L File Name.....	81
L Trace Reduction.....	82
L TX Channel.....	82
L SEM Configuration.....	82
L Chan Sel.....	82
L Import.....	82
L Export.....	82
L R&S Support.....	82
Statistics.....	82
L Settings General/Demod.....	82
L Display List/Graph.....	83
L CCDF.....	83
L Bitstream.....	83
L Signal Field (IEEE 802.11a, ac, g (OFDM), j , n, p).....	85
L Gating Settings On/Off.....	86
L PLCP Header (IEEE 802.11b, g – Single Carrier).....	86

Settings General/Demod

Opens the "General Settings" or the "Demod Settings" dialog box. For details see [chapter 4.2, "General Settings Dialog Box \(K91\)"](#), on page 87 or [chapter 4.3, "Demod Settings Dialog Box"](#), on page 97.

Alternatively, the "General Settings" dialog box is opened as follows:

- **FREQ** key, with focus on the "Frequency" field
- **AMPT** key, with focus on the "Signal Level" ("RF") field
- **TRIG** key, with focus on the "Trigger Mode" field

Display List/Graph

Configures the result display. The measurement results are displayed either in form of a list of measurement points or as a graphical trace.

For MIMO measurements (IEEE 802.11ac or n (MIMO) only) the results are provided as an overview of all data streams in the Global Result Summary (List 1), and for the individual streams in separate result summaries (List 2).

Remote command:

`DISPlay[:WINDow<n>]:TABLE` on page 165

For result queries see [chapter 5.8, "FETCh Subsystem \(WLAN\)"](#), on page 168

PVT

Opens the PVT submenu to select the Power vs Time measurement results.

The PVT result displays show the minimum, average and maximum levels measured over the full range of the measured input data, or over complete PPDU's displayed within the gating lines if gating is switched on. The results are displayed as a single PPDU. Using screen B in full screen provides additional power information during this measurement.

For IEEE 802.11b and g (single carrier), the PVT results are displayed as percentage values of the reference power. The reference can be set to either the max or mean power of the PPDU. For both rising and falling edges two time lines are displayed, which mark the points 10 % and 90 % of the reference power. The time between these two points is compared against the limits specified for the rising and falling edges.

For further details see also [chapter 3.8.3, "Rise/Fall Time Measurement"](#), on page 50

Remote command:

`CONFigure:BURSt:PVT[:IMMediate]` on page 148

Full Burst ← PVT

Displays the PVT results in a single graph with all PPDU data being displayed.

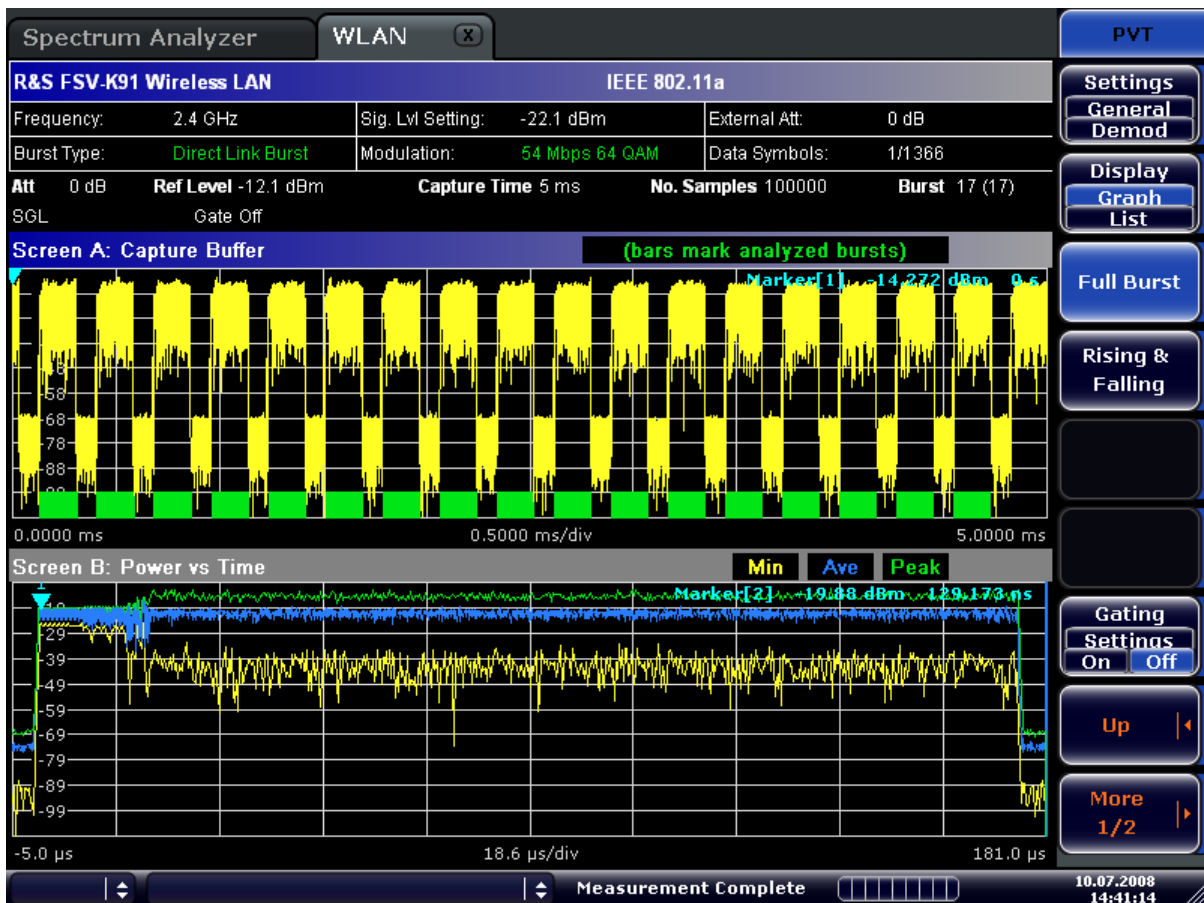

For further details refer to the "PVT" on page 64 softkey.

Remote command:

`CONFigure:BURSt:PVT:SElect` on page 149

Rising & Falling ← PVT

Displays the PVT results in two separate graphs, the left hand side showing the rising edge and the right hand side showing the falling edge.

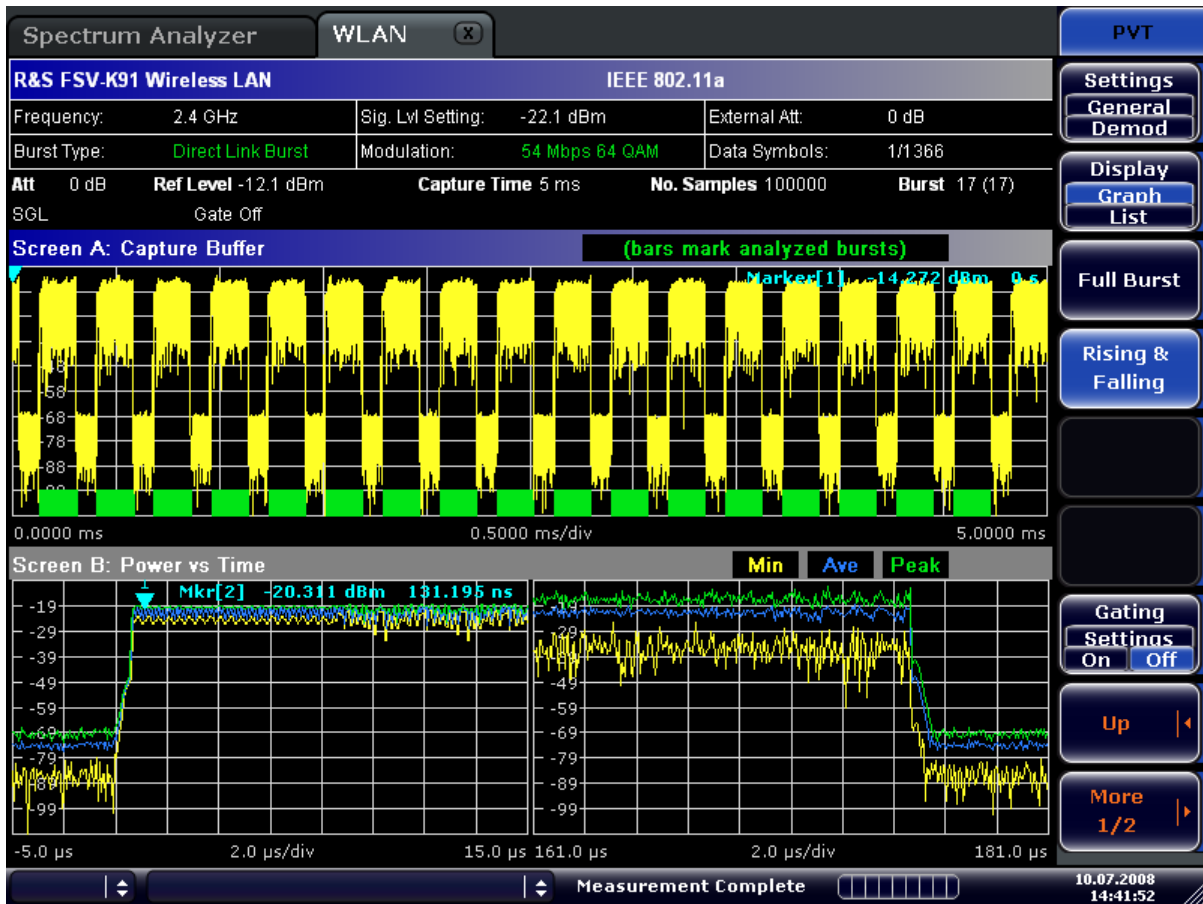

Remote command:

`CONFigure:BURSt:PVT:SElect` on page 149

Ramp Up/Down/Up & Down (IEEE 802.11b, g – Single Carrier) ← PVT

Sets the display of the rising/falling edge graph:

Up	Displays the rising edge graph.
Down	Displays the falling edge graph.
Up & Down	Displays the rising and falling edge graph.

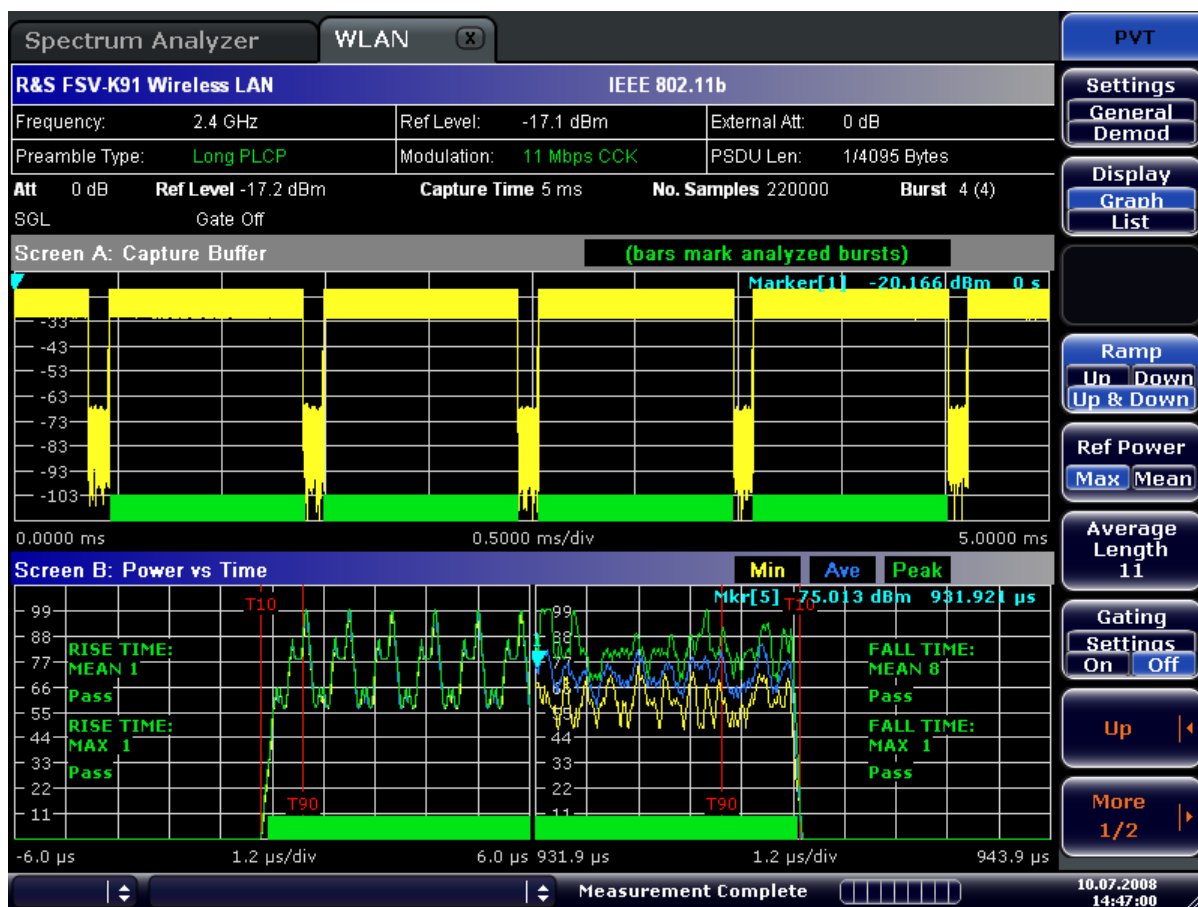

For further details refer to the "PVT" on page 64 softkey.

Remote command:

`CONFigure: BURSt: PVT: SElect` on page 149

Ref Pow Max/Mean (IEEE 802.11b, g – Single Carrier) ← PVT

Sets the reference for the rise and fall time calculation to the maximum or mean PPDU power.

For further details refer to the "PVT" on page 64 softkey.

Remote command:

`CONFigure: BURSt: PVT: RPOWer` on page 149

Average Length (IEEE 802.11b, g – Single Carrier) ← PVT

Opens an edit dialog box to enter the number of samples in order to adjust the length of the smoothing filter.

For further details refer to the "PVT" on page 64 softkey.

Remote command:

`CONFigure: BURSt: PVT: AVERage` on page 149

Gating Settings On/Off ((IEEE 802.11a, b, g, j, p) ← PVT

Activates or deactivates gating, and opens the "Gate Settings" dialog box to specify range of captured data used in results calculation.

On	Uses only the specified range of captured data in results calculation. In the Magnitude Capture Buffer trace, two vertical lines mark the specified range.
Off	Uses all the captured data in results calculation.

In the "Gate Settings" dialog box, the following parameters are set:

Delay	Start point of captured data to be used in results calculation, i.e. the delay from the start of the captured data in time or samples. If the delay is specified in time, the number of samples is updated accordingly, and vice versa.
Length	Amount of captured data to be used in results calculation. If the length is specified in time, the number of samples is updated accordingly, and vice versa.
Mode	Sets the type of triggering (level or edge) by the external gate signal.
Link Gate and Mark	If activated, the position of the marker and the gate lines are linked. The marker is positioned half way between gate start and end. The marker position alters when the gate is modified, and the gate lines move with the marker when the marker position is altered.

The gate settings are defined for following measurements: PVT, Spectrum FFT, CCDF, Spectrum Mask, Spectrum ACPR.

If a frequency sweep measurement is active (Spectrum Mask and Spectrum ACP) the result display is switched to the Magnitude Capture Buffer display in order to allow the gate to be set the correct part of the sweep.

Remote command:

```
SWE:EGAT ON
SWE:EGAT:HOLD 125us, SWE:EGAT:HOLD:SAMP 2500 (Delay)
SWE:EGAT:LENG 20ms, SWE:EGAT:LENG:SAMP 200000 (Length)
SWE:EGAT:TYPE EDGE (Mode)
SWE:EGAT:LINK ON (Link Gate and Mark), see [SENSe:]SWEep:EGATe:LINK
on page 202
```

Import ← PVT

Opens the "Choose the file to import" dialog box.

Select the IQ data file you want to import and press ENTER. The extension of data files is *.iqw.

This function is not available while a measurement is running.

Remote command:

```
MMEMory:LOAD:IQ:STATe on page 180
```

Export ← PVT

Opens the "Choose the file to export" dialog box.

Enter the path and the name of the I/Q data file you want to export and press ENTER. The extension of data files is *.iqw. If the file cannot be created or if there is no valid I/Q data to export an error message is displayed.

This function is not available while a measurement is running.

Remote command:

```
MMEMory:STORe:IQ:STATe on page 180
```

R&S Support ← PVT

Stores useful information for troubleshooting in case of errors.

This data is stored in the `C:\R_S\Instr\user\Support` directory on the instrument.

If you contact the Rohde&Schwarz support to get help for a certain problem, send these files to the support in order to identify and solve the problem faster.

EVM Constell

Opens a submenu to select the error vector magnitude (EVM) or the constellation result displays.

Settings General/Demod ← EVM Constell

See "[Settings General/Demod](#)" on page 64

Display List/Graph ← EVM Constell

See "[Display List/Graph](#)" on page 64

EVM vs Symbol/Carrier ← EVM Constell

Selects the EVM vs Symbol or EVM vs Carrier result displays.

- EVM vs Symbol

This result display shows the EVM measured over the full range of the measured input data. The results are displayed on a per-symbol basis, with blue vertical lines marking the boundaries of each PPDU. Note that PPDU boundary lines are only displayed if the number of analyzed PDUs is less than 250.

For IEEE 802.11a, j, g (OFDM) n & p the minimum, average, and maximum traces are displayed.

For IEEE 802.11b, g (Single Carrier) two EVM traces are displayed. The trace labeled with VEC ERR IEEE shows the error vector magnitude as defined in the IEEE 802.11b, g standards. For the trace labeled with EVM a commonly used EVM definition is applied, which is the square root of the momentary error power normalized by the averaged reference power.

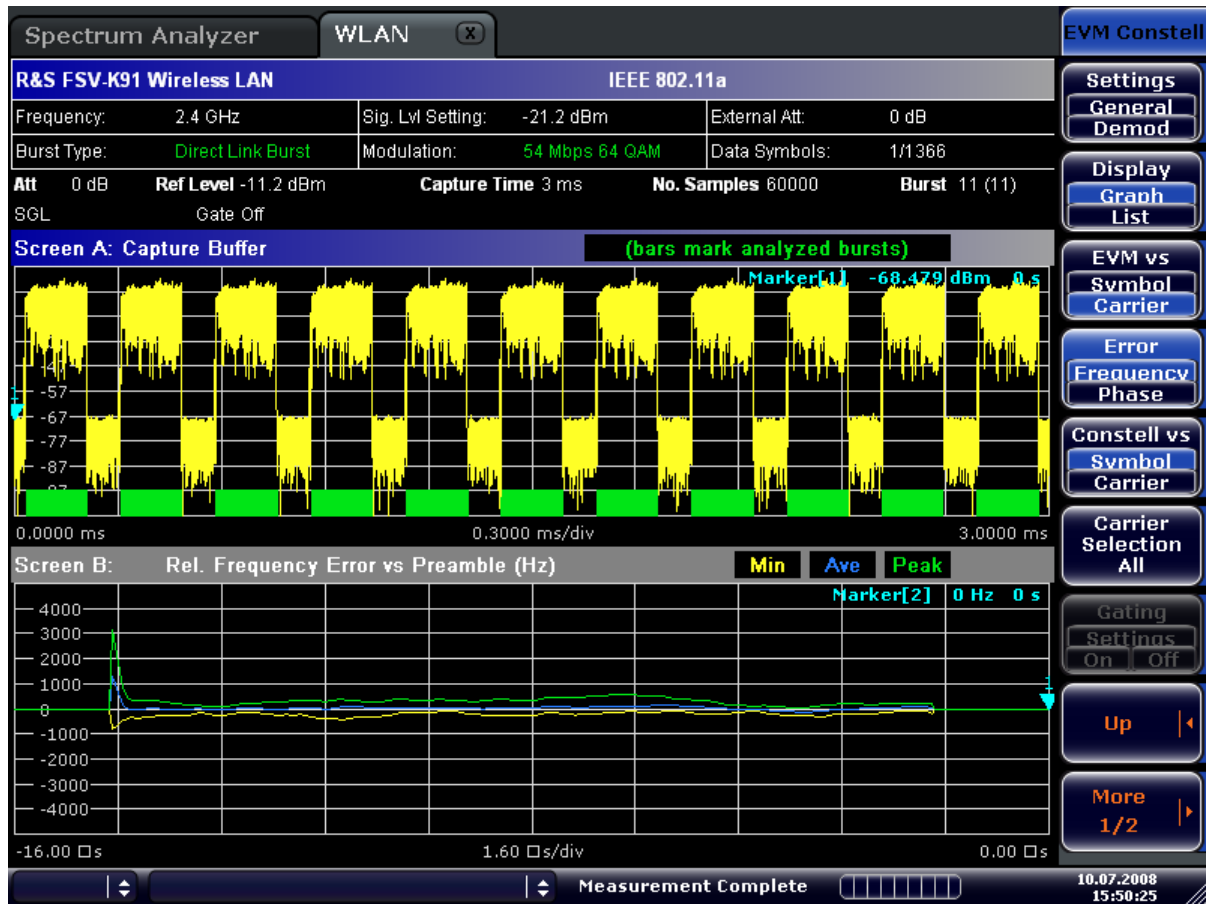

- EVM vs Carrier (IEEE 802.11a, g, j – OFDM),n & p
This result display shows all EVM values recorded on a per-carrier basis over the full set of measured data. An average trace is also displayed.

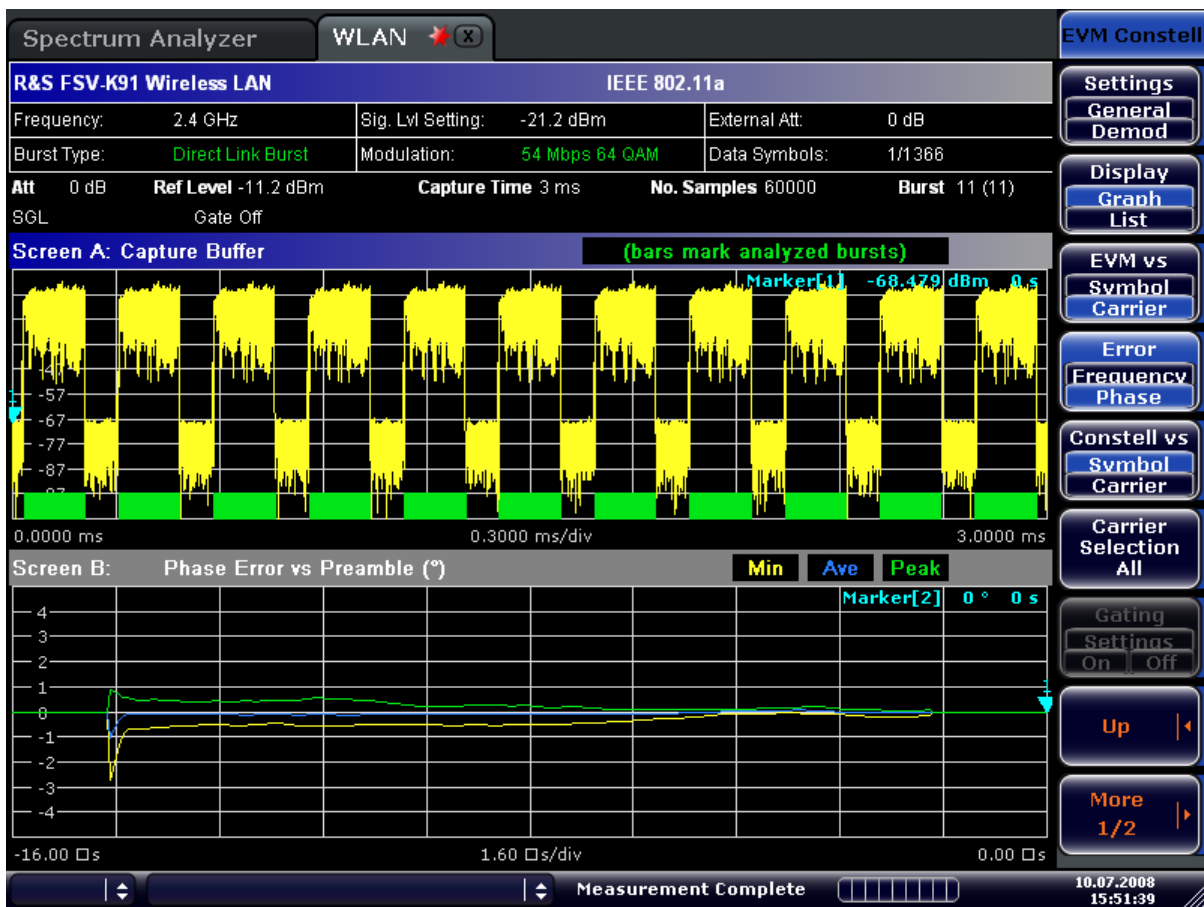

Remote command:

[CONFigure:BURSt:EVM:ESYMBOL\[:IMMEDIATE\]](#) on page 148

[CONFigure:BURSt:EVM:ECARRIER\[:IMMEDIATE\]](#) on page 147

Error Frequency/Phase ← EVM Constell

Selects the Rel. Frequency Error vs Preamble or the Phase Error vs Preamble result displays.

These result displays show the error values recorded over the preamble part of the PPDU. A minimum, average and maximum trace are displayed. The results display either relative frequency error or phase error.

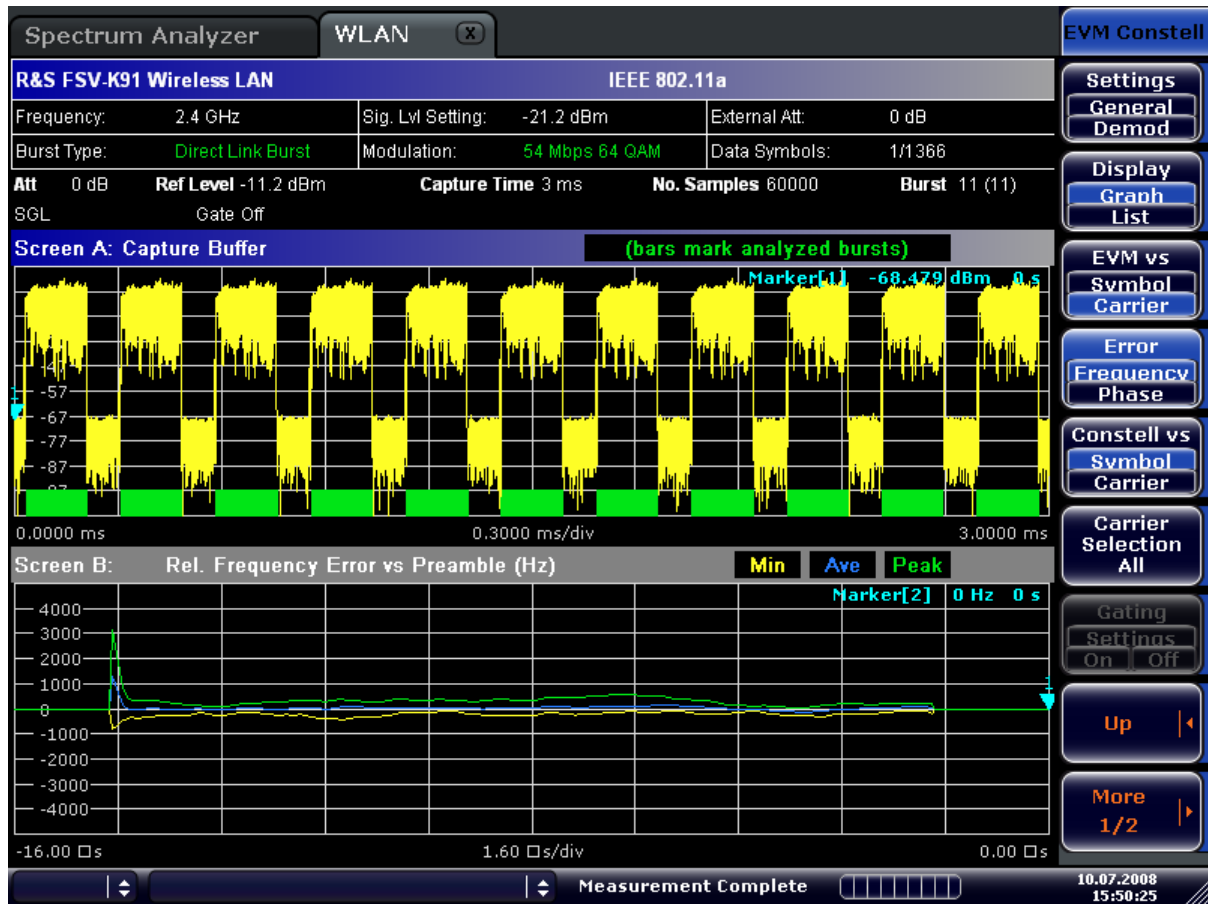

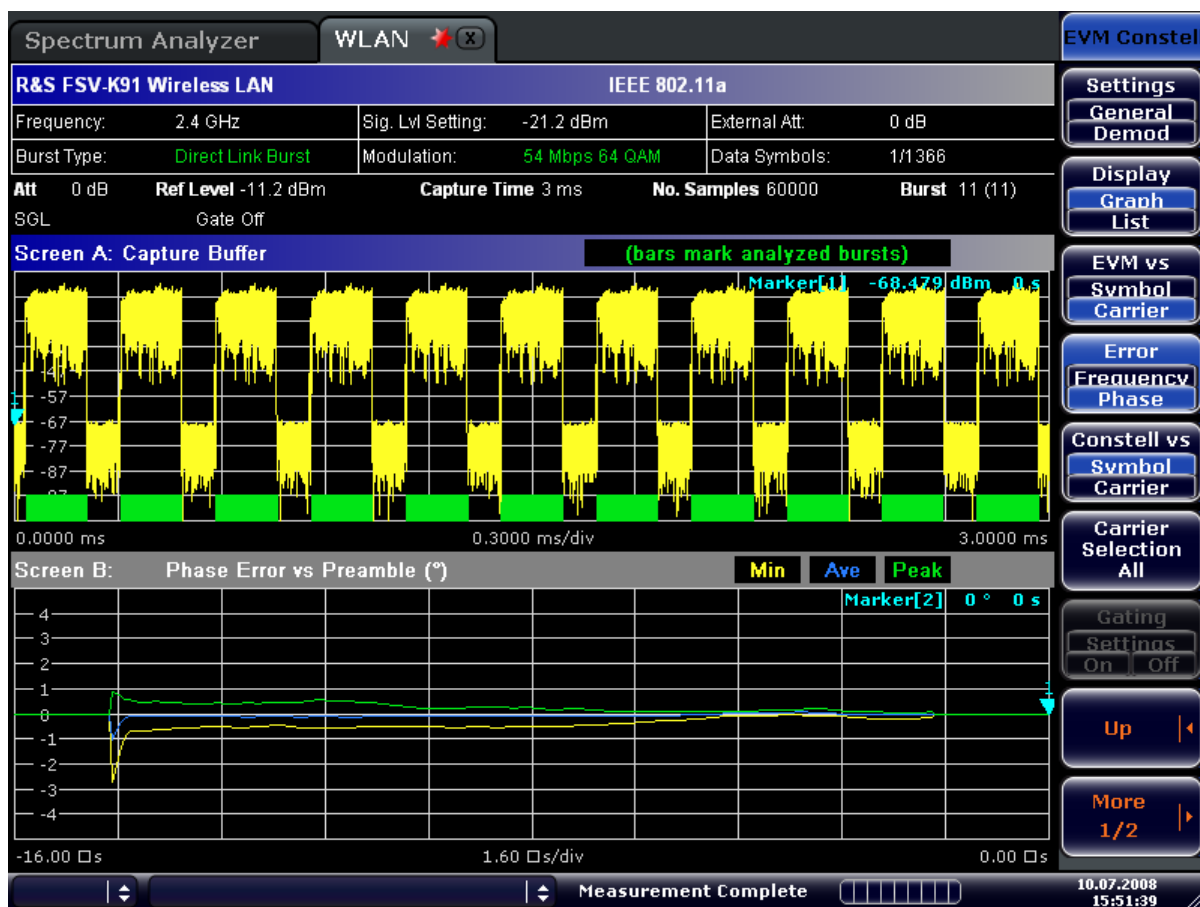

Remote command:

[CONFigure:BURSt:PREamble\[:IMMediate\]](#) on page 148

[CONFigure:BURSt:PREamble:SElect](#) on page 148

[CONFigure:BURSt:PREamble:SElect](#) on page 148

Constell vs Symbol/Carrier ← EVM Constell

Selects the Constellation vs Symbol or the Constellation vs Carrier result displays.

- Constellation vs Symbol (all standards)
This result display shows the in-phase and quadrature phase results over the full range of the measured input data. The ideal points for the selected modulations scheme are displayed for reference purposes.
The amount of data displayed in the Constellation result display can be reduced by selecting the carrier or carriers for which data is to be displayed ("[Carrier Selection \(IEEE 802.11a, ac, g, j, n \(OFDM\), p\)](#)" on page 75 softkey).

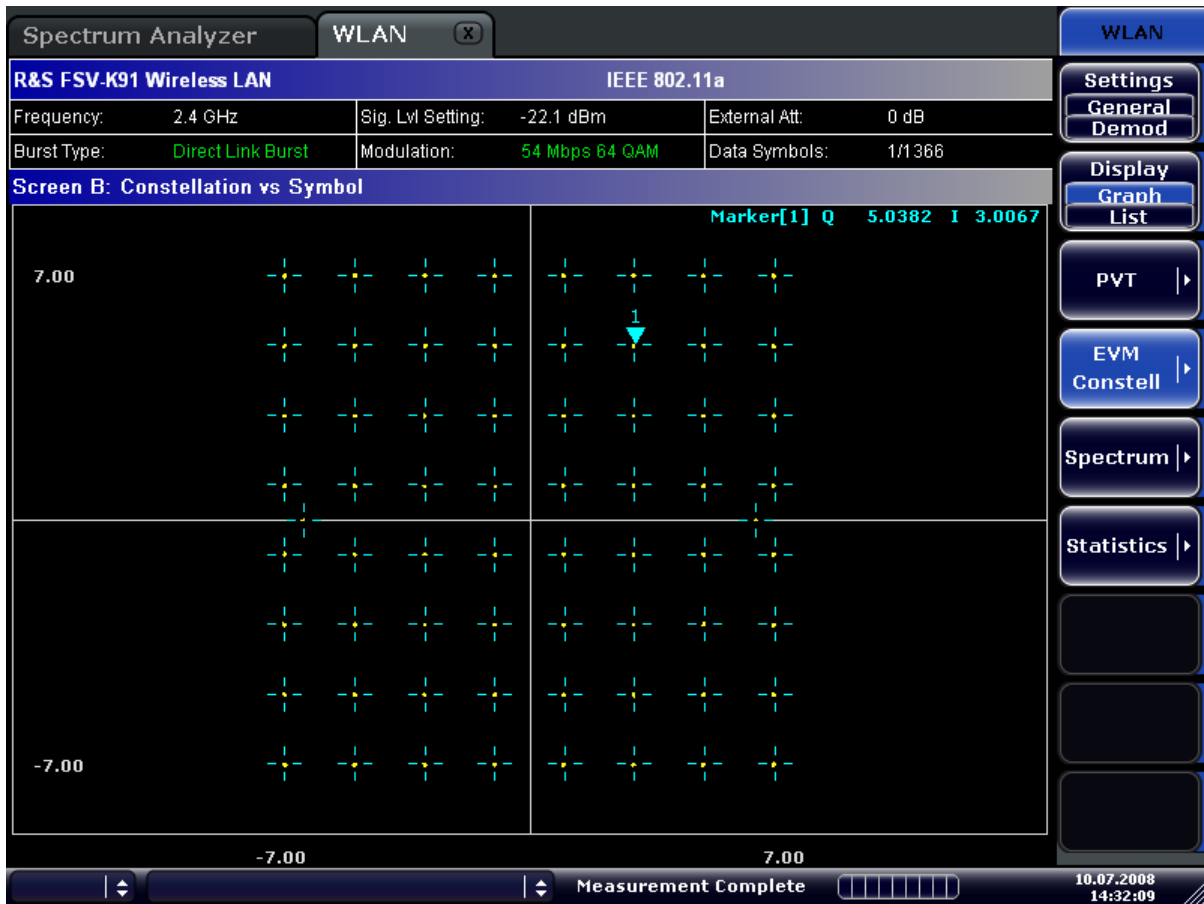

- Constellation vs Carrier (IEEE 802.11a, g, j – OFDM),n & p
This result display shows the in-phase and quadrature phase results over the full range of the measured input data plotted on a per-carrier basis. The magnitude of the in-phase and quadrature part is shown on the y-axis, both are displayed as separate traces (I-> trace 1, Q-> trace 2).

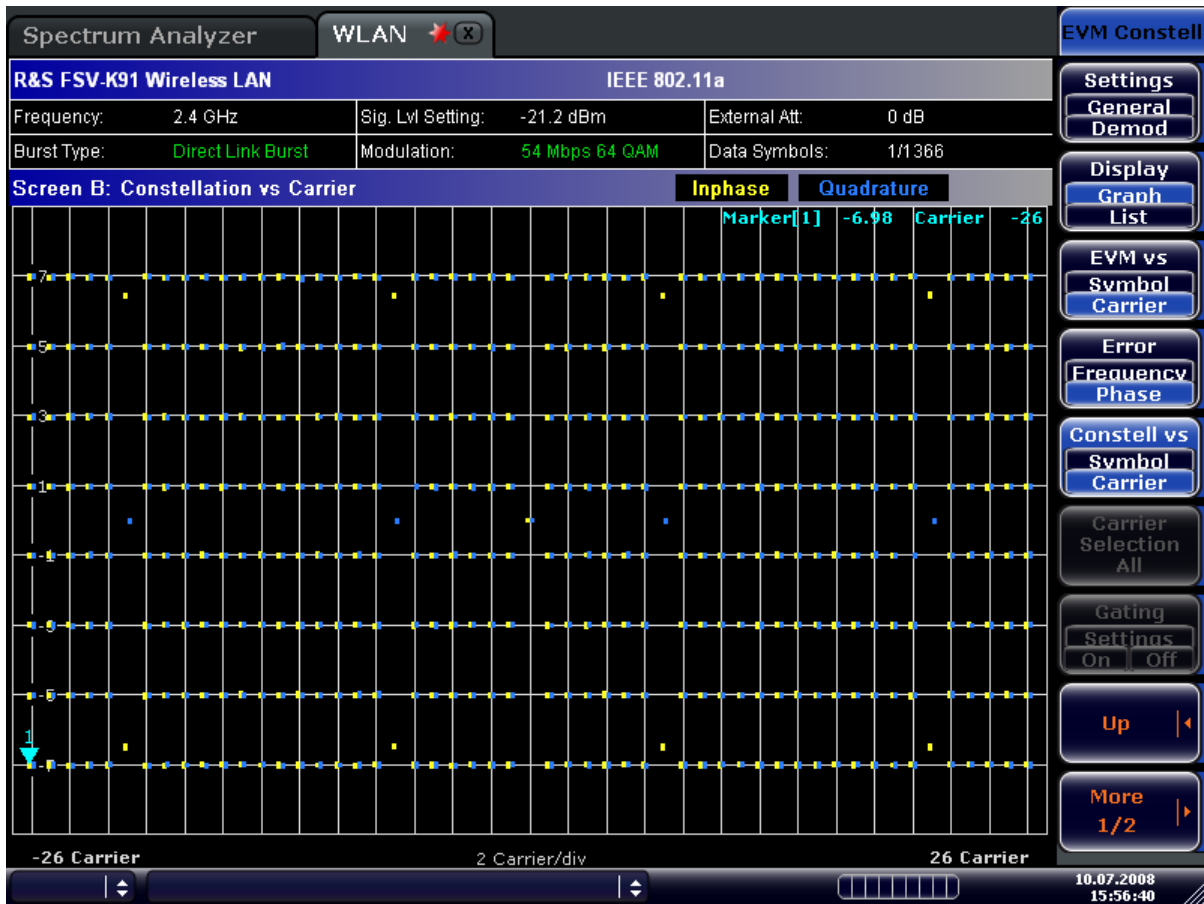

Remote command:

[CONFigure:BURSt:CONStellation:CSYMBOL\[:IMMEDIATE\]](#) on page 147

[CONFigure:BURSt:CONStellation:CCARRIER\[:IMMEDIATE\]](#) on page 147

Carrier Selection (IEEE 802.11a, ac, g, j, n (OFDM), p) ← EVM Constell

Opens a dialog box to select the carrier for data display. Either a specific carrier number, pilots only or all carriers can be selected.

Remote command:

[CONFigure:BURSt:CONStellation:CARRIER:SELEct](#) on page 146

Gating Settings On/Off ← EVM Constell

See "[Gating Settings On/Off \(\(IEEE 802.11a, b, g, j, p\)\)](#)" on page 67.

Import ← EVM Constell

See "[Import](#)" on page 68.

Export ← EVM Constell

See "[Export](#)" on page 68.

Y-Axis/Div ← EVM Constell

Opens a dialog box to modify the y-axis settings:

Auto Scaling	If activated, the scaling of the y-axis is calculated automatically.
Per Division	Specifies the scaling to be used if Auto Scaling is deactivated.
Unit	Specifies the y-axis unit. With the unit is dB, Auto Scaling is always activated.

Remote command:

[DISPlay\[:WINDow<n>\]:TRACe<t>:Y\[:SCALe\]:AUTO](#) on page 165

[DISPlay\[:WINDow<n>\]:TRACe<t>:Y\[:SCALe\]:PDIVision](#) on page 166

R&S Support ← EVM Constell

See "[R&S Support](#)" on page 69.

Spectrum

Opens a submenu for frequency measurements.

Settings General/Demod ← Spectrum

See "[Settings General/Demod](#)" on page 64

Display List/Graph ← Spectrum

See "[Display List/Graph](#)" on page 64

Spectrum Flatness (IEEE 802.11a, ac, g, j, n (OFDM), p / Group Delay (IEEE 802.11 n (MIMO)) ← Spectrum

Sets the Spectrum Flatness result display.

This result display shows the spectrum flatness and group delay values recorded on a per-carrier basis over the full set of measured data. An average trace is also displayed for each of the result types. An upper and lower limit line representing the limits specified for the selected standard are displayed and an overall pass/fail status is displayed for the obtained (average) results against these limit lines.

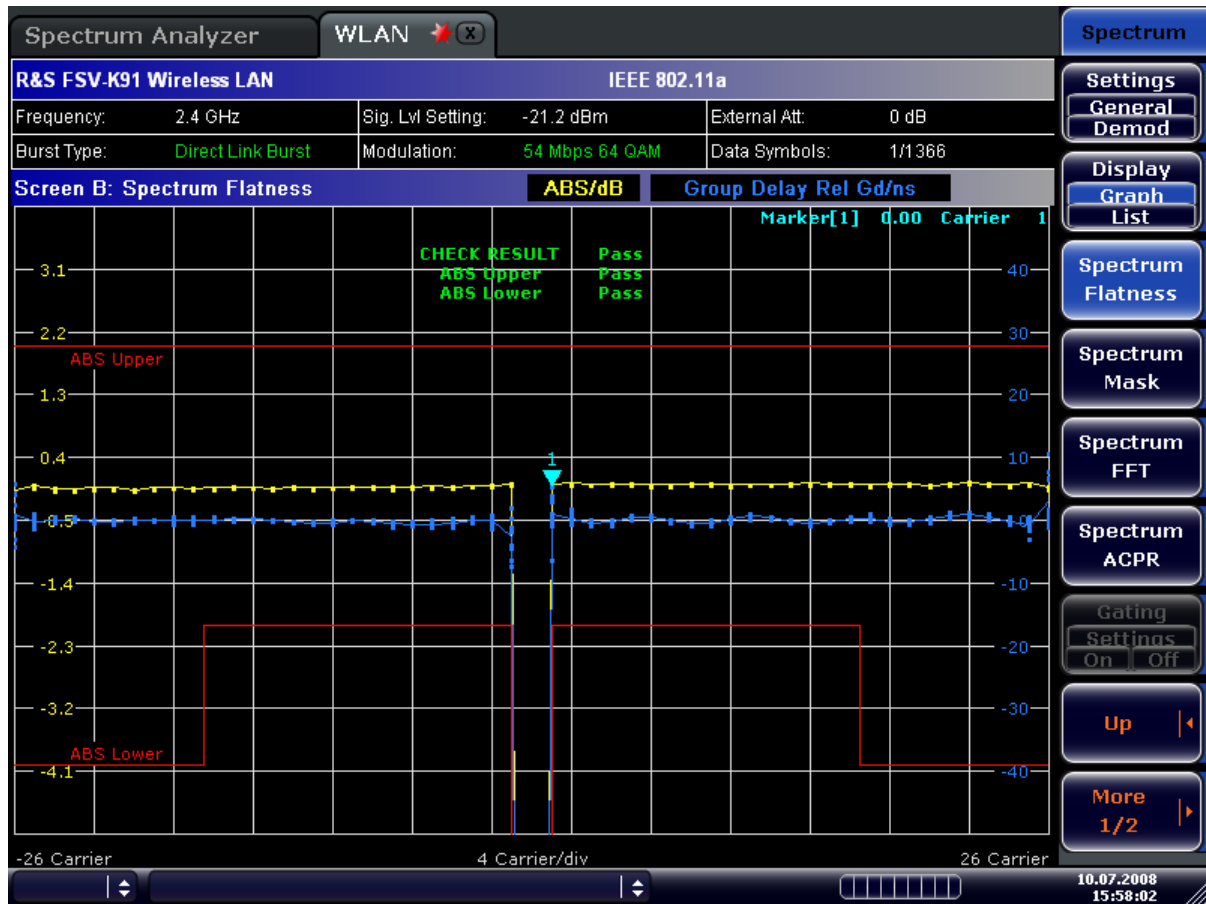

Fig. 4-1: Spectrum flatness result for IEEE 802.11a standard measurement

For IEEE 802.11ac or n (MIMO) you can select between the physical and effective channel model for the spectrum flatness and group delay measurement (see "Chan Sel" on page 82).



Fig. 4-2: Spectrum flatness result for IEEE 802.11n (MIMO) with 2 streams

Remote command:

`CONFigure:BURSt:SPECTrum:FLATness[:IMMediate]` on page 151
 IEEE 802.11n (MIMO): `CONFigure:BURSt:SPECTrum:FLATness:SElect`
 on page 151

Spectrum Mask (IEEE 802.11ac, b, g (Single Carrier)) / Spectrum IEEE/ETSI (IEEE 802.11a, g, j, n (OFDM), p) ← Spectrum
 Sets the Spectrum Mask result display.

This result display shows power against frequency. The span of the results is 100 MHz for IEEE and 500 MHz for ETSI around the specified measurement frequency. A limit line representing the spectrum mask specified for the selected standard is displayed and an overall pass/fail status is displayed for the obtained results against this limit line.

The number of sweeps is set in the General Settings dialog box, Sweep Count field. If the measurement is performed over multiple sweeps both a max hold trace and an average trace are displayed.

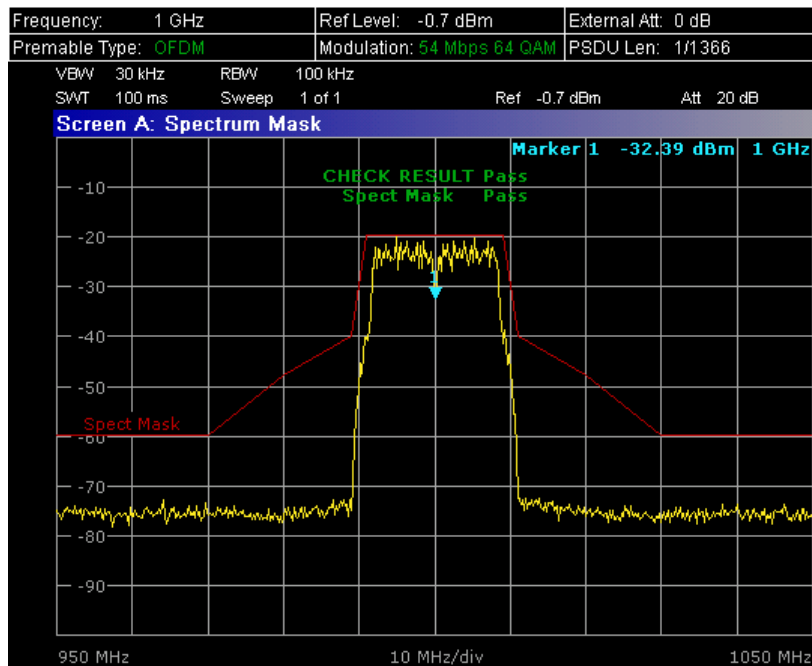

Remote command:

[CONFigure:BURSt:SPECTrum:MASK\[:IMMediate\]](#) on page 152

[CONFigure:BURSt:SPECTrum:MASK:SElect](#) on page 152

Spectrum FFT ← Spectrum

Sets the Spectrum FFT result display.

This result display shows the Power vs Frequency results obtained from a FFT performed over the range of data in the Magnitude Capture Buffer which lies within the gate lines.

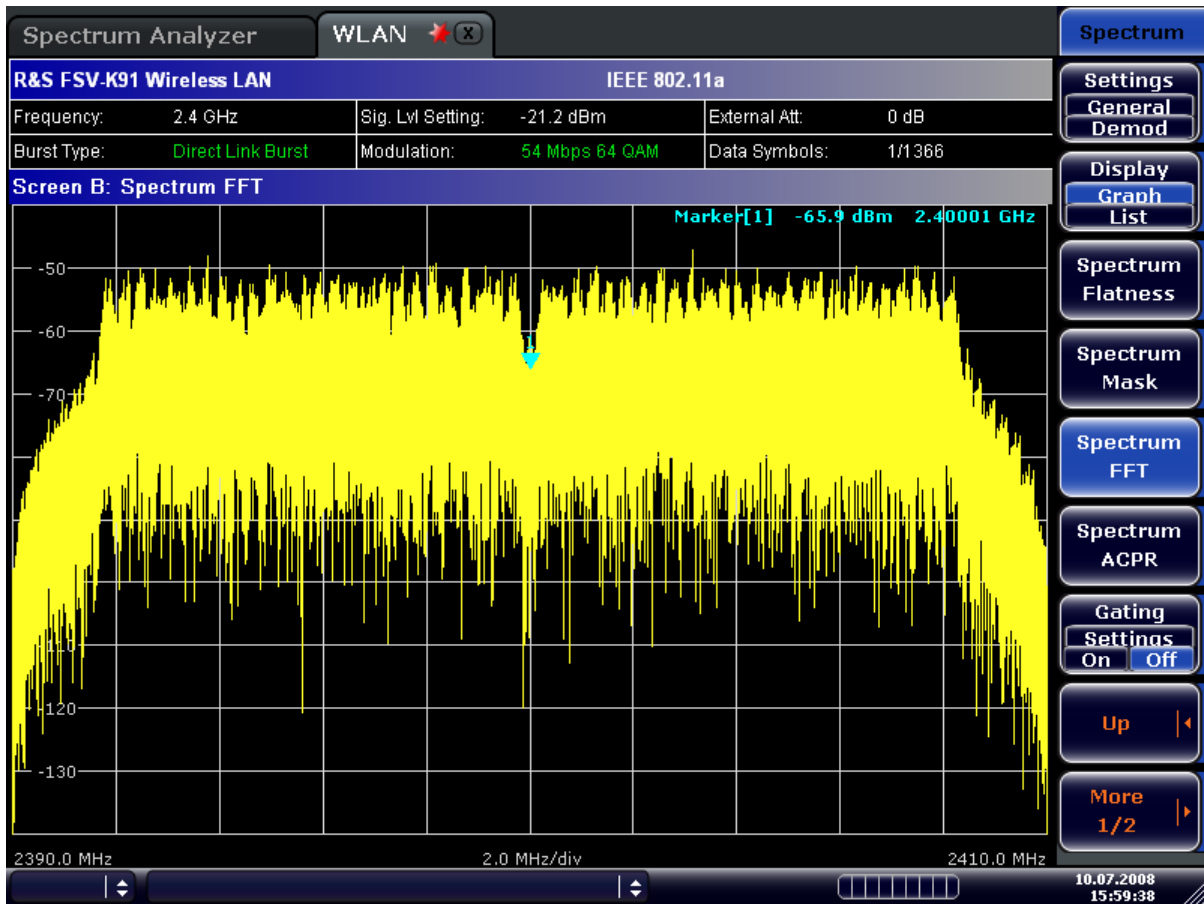

Remote command:

`CONFigure:BURSt:SPECTrum:FFT[:IMMediate]` on page 150

Spectrum ACPR (IEEE 802.11a, ac, g (OFDM Turbo Mode), n, p)/ Spectrum ACP (IEEE 802.11b)/ ACP Rel/Abs (IEEE 802.11j) ← Spectrum

Sets the ACP (Adjacent Channel Power) result display.

This result display is similar to the Spectrum Mask measurement, and provides information about leakage into adjacent channels. The results show the absolute or relative power measured in the three nearest channels either side of the measured channel. This measurement is the same as the adjacent channel power measurement provided by the signal analyzer.

The number of sweeps is set in the General Settings dialog box, Sweep Count field. If the measurement is performed over multiple sweeps both a max hold trace and an average trace are displayed.

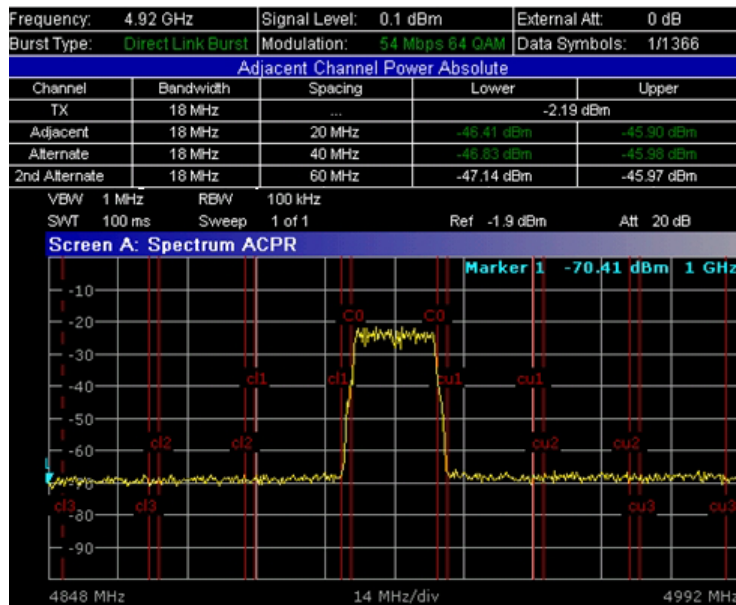

Remote command:

[CONFigure: BURSt: SPECTrum: ACPR\[: IMMEDIATE\]](#) on page 150

[CALCulate<n>: MARKer<1>: FUNCTION: POWER: RESULT\[: CURRENT\]?](#)

on page 144

[CALCulate<n>: MARKer<1>: FUNCTION: POWER: RESULT: MAXHold?](#) on page 144

Gating Settings On/Off ← Spectrum

See "Gating Settings On/Off ((IEEE 802.11a, b, g, j, p))" on page 67.

SEM Settings ← Spectrum

Displays the "SEM Settings" dialog box that contains the following editable settings:

SEM according to ← SEM Settings ← Spectrum

Specifies how the Spectrum Emission Mask settings and limits are applied. The following standards are supported:

- | | |
|--------|---|
| "ETSI" | Settings and limits are as specified in the standard |
| "IEEE" | Settings and limits are as specified in the IEEE Std 802.11n™-2009 Figure 20-17—Transmit spectral mask for 20 MHz transmission. For other IEEE standards see table 5-1 in the remote command description. |
| "User" | Settings and limits are configured via an XML file |

Remote command:

[\[SENSe:\] POWER: SEM](#) on page 198

File Name ← SEM Settings ← Spectrum

When "SEM according to": "User" settings are specified, "File Name" shows the name of the loaded XML file. Clicking the arrow switches to the File Manager to locate an XML file, and automatically selects "SEM according to": "User".

When using "ETSI" or "IEEE" standards, "File Name" indicates the name of the built-in configuration.

Remote command:

[MMEMory:LOAD:SEM:STATe 1](#), on page 180

Trace Reduction ← SEM Settings ← Spectrum

During the Spectrum Emission Mask (SEM) measurement data is acquired and trace data is selected according to the trace detector setting from the SEM xml definition file for each frequency range. Alternatively, the peak detector can be used regardless of the setting in the SEM definition file.

"Peak" For each frequency range, the peak detector is used to determine the corresponding trace value. This was the behaviour for the SEM measurement in R&S FSV-K91 versions before 1.70.

"Trace detector" For each frequency range, the trace detector defined in the SEM xml file is used to determine the corresponding trace value.

Remote command:

[\[SENSe:\]POWER:SEM:TRACe:REDUction](#) on page 200

TX Channel ← SEM Settings ← Spectrum

The bandwidth and RBW of the transmission channel are displayed for reference only.

SEM Configuration ← SEM Settings ← Spectrum

The table shows the settings and limits applied over specified frequency ranges around the TX channel.

Chan Sel ← Spectrum

Selects the channel model for the Spectrum Flatness measurement.

"Effective" The composition of the physical channel and the MIMO encoder.

"Physical" Physical channel

Remote command:

[CONFigure:BURSt:SPECTrum:FLATness:CSElect](#) on page 151

Import ← Spectrum

See ["Import"](#) on page 68.

Export ← Spectrum

See ["Export"](#) on page 68.

R&S Support ← Spectrum

See ["R&S Support"](#) on page 69.

Statistics

Opens a submenu to display statistics measurement results.

Settings General/Demod ← Statistics

See ["Settings General/Demod"](#) on page 64

Display List/Graph ← Statistics

See "Display List/Graph" on page 64

CCDF ← Statistics

Sets the CCDF result display.

This result display shows the probability of an amplitude within the gating lines exceeding the mean power measured between the gating lines. The x-axis displays power relative to the measured mean power.



Remote command:

`CONFigure:BURSt:STATistics:CCDF[:IMMediate]` on page 152

Bitstream ← Statistics

Sets the Bitstream result display. This result display shows the demodulated data stream.

- IEEE 802.11a, j, g (OFDM), n, p:
The results are grouped by symbol and carrier.

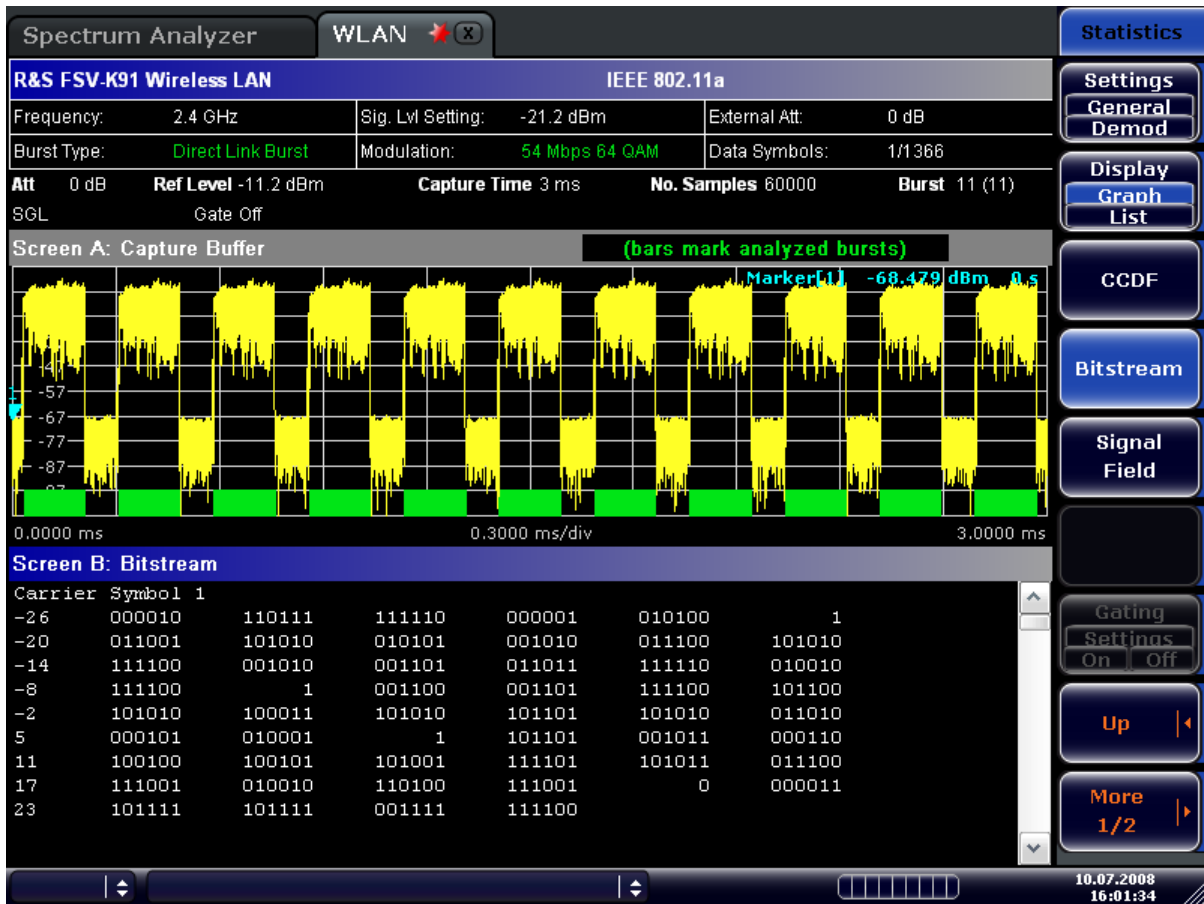

- IEEE 802.11b or g (Single Carrier)
The results are grouped by PPDU.

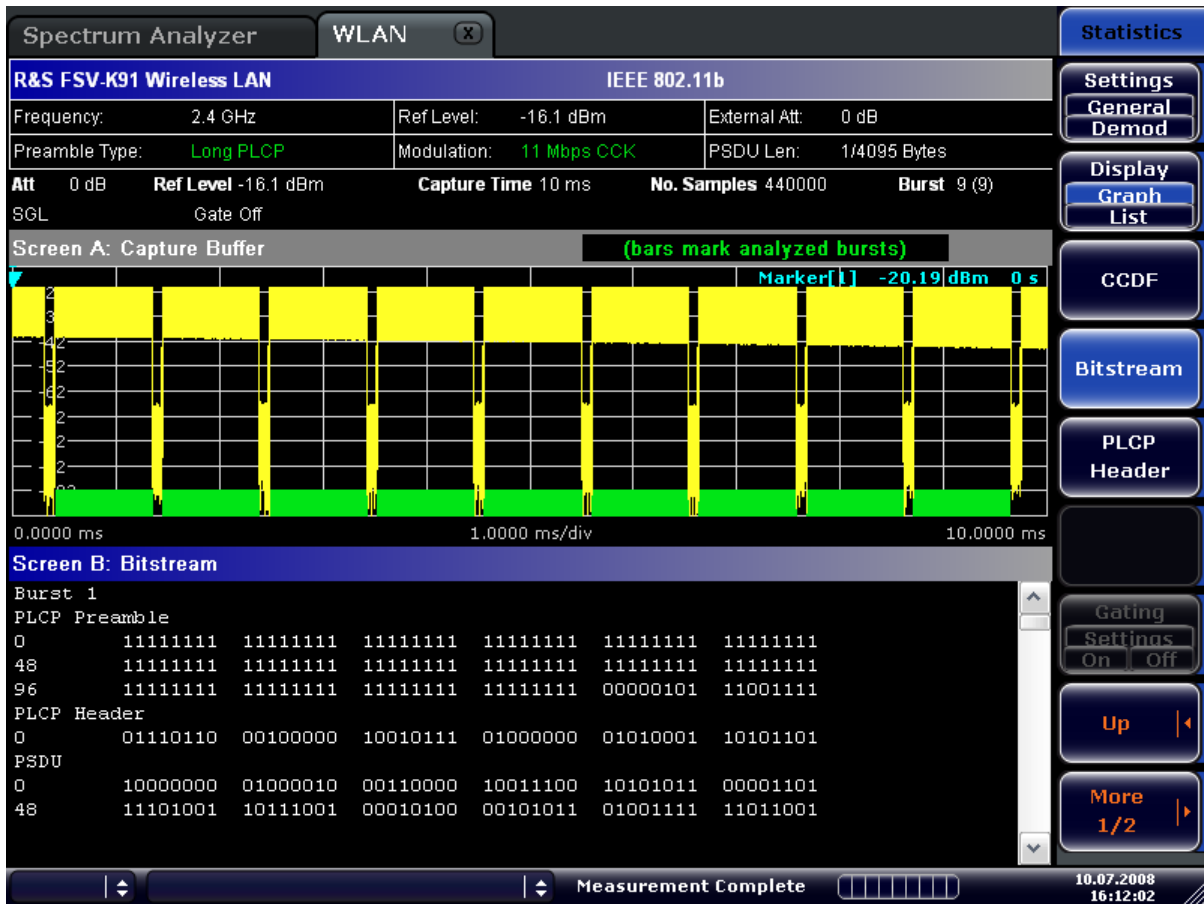

Remote command:

[CONFigure:BURSt:STATistics:BSTReam\[:IMMEDIATE\]](#) on page 152

Signal Field (IEEE 802.11a, ac, g (OFDM), j, n, p) ← Statistics

Sets the "Signal Field" result display.

This result display shows the decoded data from the signal field of the PPDU. Therefore it is only available if, in the "Demod Settings" dialog box, the "Signal Field Content" option is activated.

For the IEEE 802.11ac, n standards an enhanced Signal Field measurement is available, see [chapter 3.7, "Signal Field Measurement \(IEEE 802.11ac, n \(SISO+MIMO\)\)"](#), on page 39.

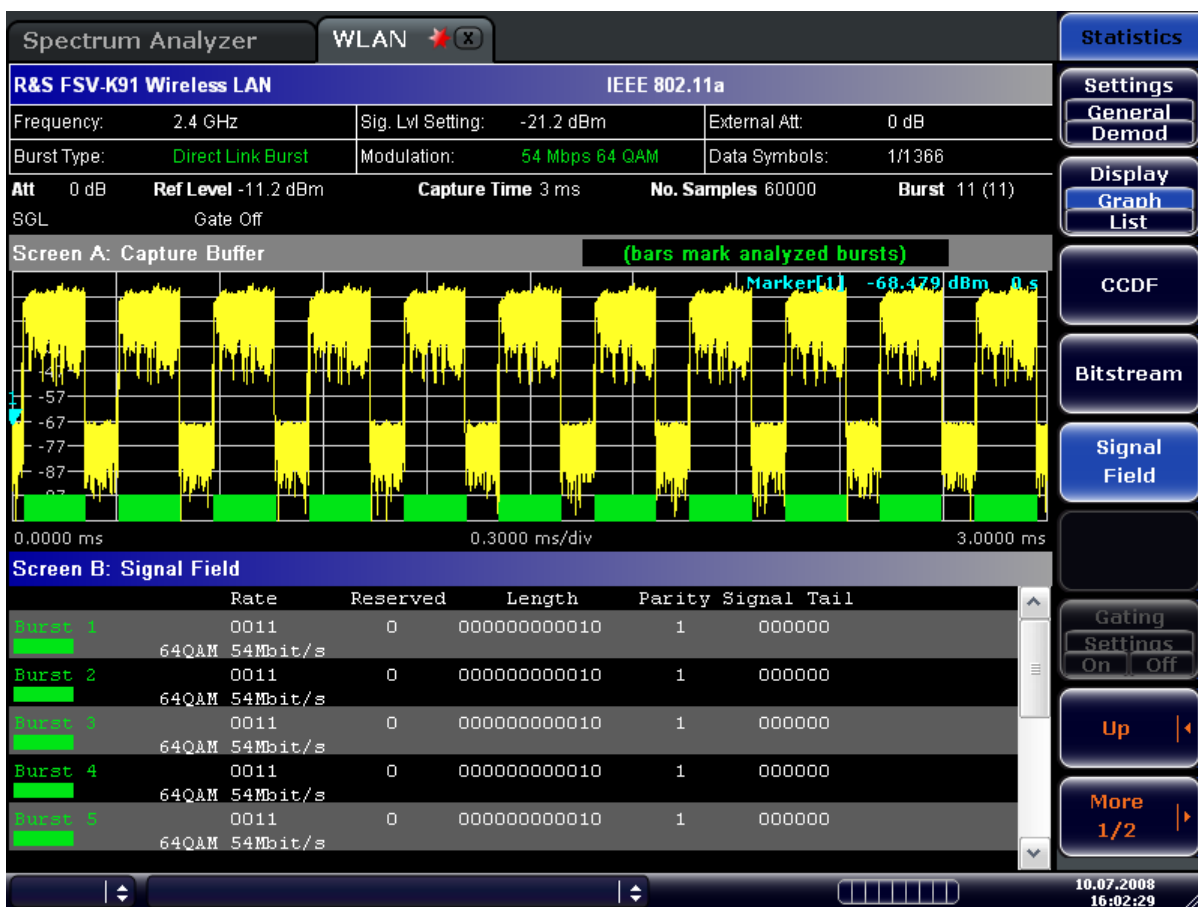

Remote command:

`CONFigure:BURSt:STATistics:SFIeld[:IMMediate]` on page 153

Gating Settings On/Off ← Statistics

See "Gating Settings On/Off ((IEEE 802.11a, b, g, j, p))" on page 67.

PLCP Header (IEEE 802.11b, g – Single Carrier) ← Statistics

This result display shows the decoded data from the PLCP header of the PPDU. The following details are listed:

Column header	Description	Example
PPDU	number of the decoded PPDU A colored block indicates that the PPDU was successfully decoded.	Burst 1
Signal	signal field The decoded data rate is shown below.	00010100 2 MBits/s
Service	service field The currently used bits are highlighted. The text below explains the decoded meaning of these bits.	00000000 --/--

PSDU Length	length field The decoded time to transmit the PSDU is shown below.	00000000111100 0 120 µs
CRC	CRC field The result is displayed below (OK for passed or Failed).	111010011100111 0 OK

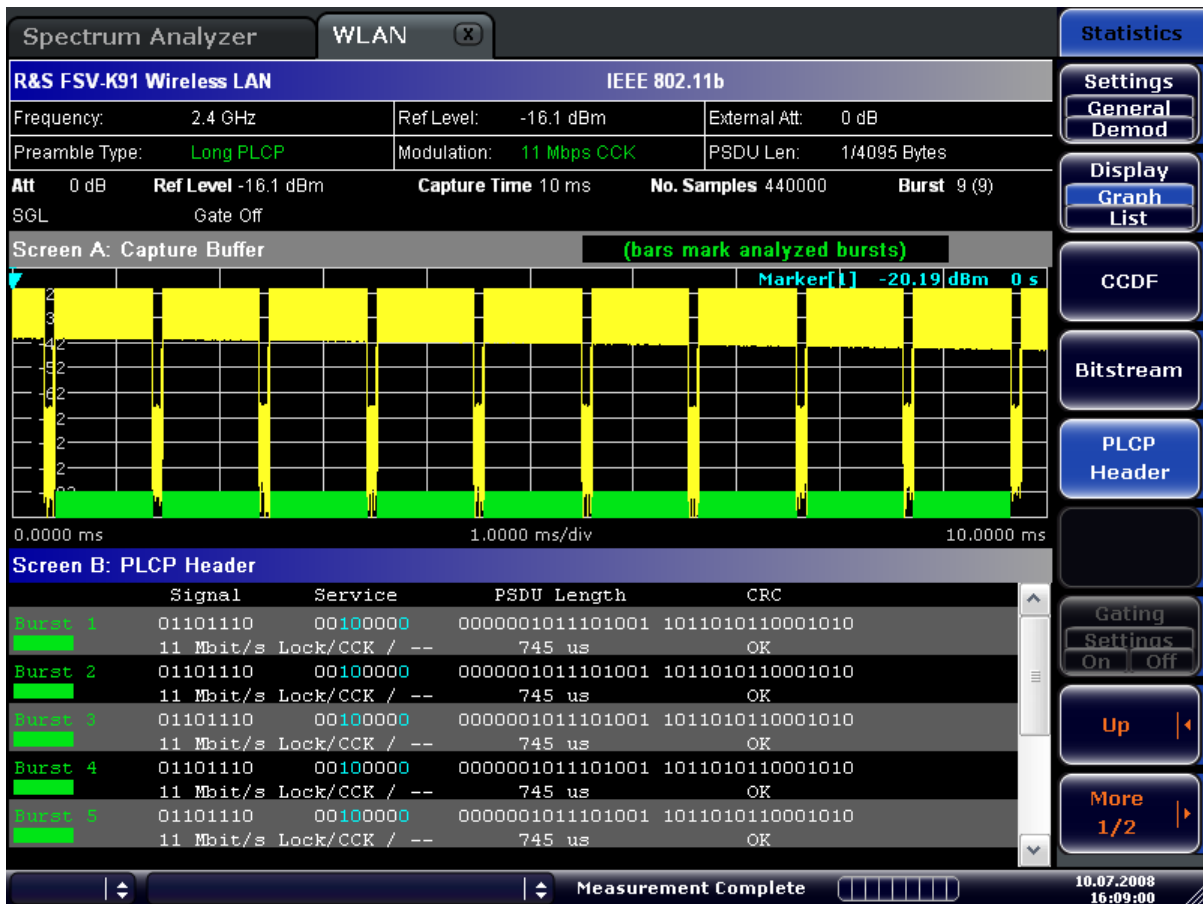

Remote command:

[CONFigure: BURSt: STATistics: SFieLd\[:IMMediate\]](#) on page 153

4.2 General Settings Dialog Box (K91)

In the **General Settings** dialog box, all settings related to the overall measurement can be modified.

The "STC/MIMO" settings are only available if the IEEE 802.11ac or n (MIMO) standard is selected.

- [General Settings](#)..... 88
- [Advanced Settings](#)..... 92
- [STC/MIMO Settings \(IEEE 802.11ac, n \(MIMO\) only\)](#)..... 93

4.2.1 General Settings

Standard	88
Frequency	88
Channel No	88
Signal Level / Reference Level.....	88
└ Auto Lvl	89
Ext Att	89
Capture Time	89
PPDU Count	89
Analyze PPDU	89
Sweep Count	90
Trigger Mode	90
Trigger Offset	90
Trigger Holdoff.....	90
Trigger Hysteresis.....	91
Ext. Trigger Lvl.....	91
Power Level	91
└ Auto Lvl	91
Input.....	91

Standard

Displays a list of all installed standards to select the wireless LAN standard. This is necessary to ensure that the measurements are performed according to the specified standard with the correct limit values and limit lines.

Remote command:

[CONFigure:STANdard](#) on page 154

Frequency

Specifies the center frequency of the signal to be measured. If the frequency is modified, the "Channel No" field is updated accordingly.

Remote command:

[\[SENSe:\]FREQuency:CENTer](#) on page 197

Channel No

Specifies the channel to be measured. If the "Channel No" field is modified, the frequency is updated accordingly.

Remote command:

[CONFigure:CHANnel](#) on page 153

Signal Level / Reference Level

Specifies the expected mean level of the RF input signal. If an automatic level detection measurement has been executed the signal level (RF) is updated.

For all standards other than IEEE 802.11b & g (Single Carrier), the reference level is set 10 dB higher than the signal level (RF) because of the expected crest factor of the signal. For standards IEEE 802.11b & g (Single Carrier), the reference level is set to the signal level (RF).

Remote command:

[CONFigure:POWer:EXPEcted:RF](#) on page 154

Auto Lvl ← Signal Level / Reference Level

Activates or deactivates the automatic setting of the reference level for measurements.

"ON" The reference level is measured automatically at the start of each measurement sweep. This ensures that the reference level is always set at the optimal level for obtaining accurate results but will result in slightly increased measurement times.

"OFF" The reference level is defined manually in the ["Signal Level / Reference Level"](#) on page 88 field.

Remote command:

[CONFigure:POWer:AUTO](#) on page 153

[CONFigure:POWer:AUTO:SWEep:TIME](#) on page 154

Ext Att

Specifies the external attenuation or gain applied to the RF signal. A positive value indicates attenuation, a negative value indicates gain. All displayed power level values are shifted by this value.

Remote command:

[INPut:ATTenuation](#) on page 177

Capture Time

Specifies the time (and therefore the amount of data) to be captured in a single measurement sweep.

Remote command:

[\[SENSe:\]SWEep:TIME](#) on page 203

PPDU Count

Activates or deactivates a specified number of PPDU's for capture and analysis.

On	The data analysis is performed over a number of consecutive sweeps until the required number of PPDU's has been captured and analyzed.
Off	The data analysis is performed on a single measurement sweep.

Remote command:

[\[SENSe:\]BURSt:COUNT:STATe](#) on page 185

Analyze PPDU's

Specifies the number of PPDU's to be measured, if the "PPDU Count" option is activated.

Remote command:

[\[SENSe:\]BURSt:COUNT](#) on page 185

Sweep Count

Specifies the number of sweeps to be performed for Spectrum ACP/ACPR and Spectrum Mask measurements.

Remote command:

[\[SENSe:\] SWEEp:COUNT](#) on page 200

Trigger Mode

Sets the source of the trigger for the data capture process of the measurement.

- "Free Run" The measurement sweep starts immediately.
- "External" The measurement sweep starts if the external trigger signal meets or exceeds the external trigger level (a fixed value that cannot be altered) at the input connector EXT TRIGGER/GATE IN on the rear panel.
- "IF Power" The measurement sweep starts when the signal power meets or exceeds the specified power trigger level. This trigger mode is not available for Spectrum Mask measurements in ETSI standard. If it is set and then the Spectrum Mask measurement in ETSI standard is selected, it automatically changes to "Free Run".
- "RF Power" The next measurement is triggered by the first intermediate frequency of the RF signal.
- "Power Sensor" The next measurement is triggered by the external power sensor (requires R&S FSV-K9 option).
- "External Using FS-Z11" If activated, the next measurement is triggered by the signal at the external trigger input connected to the R&S®FS-Z11 trigger unit. This allows for data to be captured from all connected analyzers synchronously for MIMO measurements.
For details see [chapter 3.6.1, "Trigger Synchronization Using an R&S®FS-Z11 Trigger Unit"](#), on page 37.

Remote command:

[TRIGger\[:SEQuence\]:MODE](#) on page 218

Trigger Offset

Specifies the time offset between the trigger signal and the start of the sweep. A negative value indicates a pre-trigger. This field is not available in the "Free Run" trigger mode.

Remote command:

[TRIGger\[:SEQuence\]:HOLDoff](#) on page 217

Trigger Holdoff

Defines the value for the trigger holdoff. The holdoff value in s is the time which must pass before triggering, in case another trigger event happens.

This softkey is only available if "IFPower", "RF Power" or "BBPower" is the selected trigger source.

Remote command:

[TRIGger<n>\[:SEquence\]:IFPower:HOLDoff](#) on page 217

Trigger Hysteresis

Defines the value for the trigger hysteresis for "IF power" or "RF Power" trigger sources. The hysteresis in dB is the value the input signal must stay below the power trigger level in order to allow a trigger to start the measurement. The range of the value is between 3 dB and 50 dB with a step width of 1 dB.

Remote command:

[TRIGger<n>\[:SEquence\]:IFPower:HYSteresis](#) on page 218

Ext. Trigger Lvl

Specifies the external trigger level if trigger mode "External" is used.

Remote command:

[TRIGger<n>\[:SEquence\]:LEVel\[:EXTernal\]](#) on page 218

Power Level

Specifies the trigger level if one of the "Power" trigger modes is set.

Remote command:

[TRIGger\[:SEquence\]:LEVel:POWer](#) on page 219

Auto Lvl ← Power Level

Activates or deactivates the automatic measurement of the IF power trigger level.

"ON"	The power trigger level is measured automatically at the start of each measurement sweep. This ensures that the power trigger level is always set at the optimal level for obtaining accurate results but will result in a slightly increased measurement times.
"OFF"	The power trigger level is defined manually in the "Power Level " on page 91 field.

Remote command:

[TRIGger\[:SEquence\]:LEVel:POWer:AUTO](#) on page 220

Input

The following signal sources are supported:

- RF Input
- Baseband Digital (only with Digital Baseband Interface, R&S FSV-B17)

Remote command:

[INPut:SElect](#) on page 179

4.2.2 Advanced Settings

Swap IQ	92
Input Sample Rate.....	92
Full Scale Level.....	92
Auto Level Time	92
Ref Level	92
Attenuation	93
Sample Rate	93
Meas Range (IEEE 802.11b, g).....	93

Swap IQ

Activates or deactivates the inverted I/Q modulation.

On	I and Q signals are interchanged.
Off	Normal I/Q modulation.

Remote command:

`[SENSe:] SWAPiQ` on page 200

Input Sample Rate

Defines the sample rate of the digital I/Q signal source. This sample rate must correspond with the sample rate provided by the connected device, e.g. a generator.

Remote command:

`INPut:DIQ:SRATe` on page 178

Full Scale Level

The "Full Scale Level" defines the level that should correspond to an I/Q sample with the magnitude "1".

The level is defined in Volts.

Remote command:

`INPut:DIQ:RANGe[:UPPer]` on page 178

Auto Level Time

Specifies the sweep time used for the automatic level measurements.

Remote command:

`CONFigure:POWer:AUTO:SWEep:TIME` on page 154

Ref Level

Specifies the reference level to use for measurements. If the reference level is modified, the signal level is updated accordingly (depending on the currently selected standard and measurement type). This field is only editable if the "Auto Lvl" is deactivated.

Remote command:

`DISPlay[:WINDow<n>]:TRACe<t>:Y[:SCALE]:RLEVEL?` on page 166

Attenuation

Specifies the settings for the attenuator. This field is only editable if the "Auto Lvl" option is deactivated. If the "Auto Lvl" option is activated, the RF attenuator setting is coupled to the reference level setting.

Remote command:

[INPut:ATTenuation](#) on page 177

Sample Rate

Specifies the sample rate used for IQ measurements.

For IEEE 802.11a, p: the Input Sample Rate can be chosen continuously.

For IEEE 802.11n: 20 MHz, 40 MHz, 80 MHz*

For IEEE 802.11ac: 20 MHz, 40 MHz, 80 MHz*, 160 MHz*

*) requires bandwidth extension option

Remote command:

[TRACe: IQ:SRATe](#) on page 210

Meas Range (IEEE 802.11b, g)

Defines the measurement range for the peak vector error.

"All Symbols" Peak Error Vector results are calculated over the complete PPDU

"PSDU only" Peak Error Vector results are calculated over the PSDU only

Remote command:

[CONFigure:WLAN:PVErRor:MRANge](#) on page 161

4.2.3 STC/MIMO Settings (IEEE 802.11ac, n (MIMO) only)

DUT MIMO configuration.....	93
Signal Capture.....	94
Simultaneous Signal Capture Setup.....	94
L State.....	94
L Analyzer IP Address.....	94
L Assignment.....	94
L Joined RX Sync and Tracking.....	95
Sequential Using OSP Switch Setup.....	95
L OSP IP Address.....	96
L OSP Switch Module.....	96
Manual Sequential MIMO Data Capture.....	96
L Capture.....	96
L Analyze.....	97
L Clear.....	97

DUT MIMO configuration

Defines the number of Tx antennas of the device under test (DUT). Currently up to 4 Tx antennas are supported.

Remote command:

[CONFigure:WLAN:DUTConfig](#) on page 156

Signal Capture

Defines the MIMO method used by the analyzer(s) to capture data from multiple TX antennas sent by one device under test (DUT).

All modes support RF and Analog Baseband signal input.

- "Simultaneous" Simultaneous normal MIMO operation
The number of Tx antennas set in [DUT MIMO configuration](#) defines the number of analyzers required for this measurement setup.
- "Sequential using OSP switch" Sequential using open switch platform
A single analyzer and the Rohde & Schwarz OSP Switch Platform (with at least one fitted R&S®OSP-B101 option) is required to measure the number of DUT Tx Antennas as defined in [DUT MIMO configuration](#).
- "Sequential manual" Sequential using manual operation
A single analyzer is required to measure the number of DUT Tx Antennas as defined in [DUT MIMO configuration](#). Data capturing is performed manually via the analyzer's user interface.

Remote command:

[CONFigure:WLAN:MIMo\[:CAPture\]:TYPE](#) on page 159

Simultaneous Signal Capture Setup

For each RX antenna from which data is to be captured simultaneously, the settings are configured here.

State ← Simultaneous Signal Capture Setup

Switches the corresponding slave analyzer On or Off. In On state the slave analyzer captures data. This data is transferred via LAN to the master for analysis of the MIMO system.

Remote command:

[CONFigure:WLAN:ANTMatrix:STATe<RecPath>](#) on page 156

Analyzer IP Address ← Simultaneous Signal Capture Setup

Defines the IP addresses of the slaves connected via LAN to the master.

Remote command:

[CONFigure:WLAN:ANTMatrix:ADDRESS<RecPath>](#) on page 155

Assignment ← Simultaneous Signal Capture Setup

Assignment of the expected antenna to an analyzer. For a wired connection the assignment of the Tx antenna connected to the analyzer is a possibility. For a wired connection and Direct Spatial Mapping the Spectrum Flatness traces in the diagonal contain the useful information, in case the signal transmitted from the antennas matches with the expected antennas. Otherwise the secondary diagonal will contain the useful traces.

Remote command:

[CONFigure:WLAN:ANTMatrix:ANTenna<RecPath>](#) on page 155

Joined RX Sync and Tracking ← Simultaneous Signal Capture Setup

This command configures how PPDU synchronization and tracking is performed for multiple captured antenna signals.

"ON" RX antennas are synchronized and tracked together.

"OFF" RX antennas are synchronized and tracked separately.

Remote command:

CONFigure:WLAN:RSYNc:JOINed on page 161

Sequential Using OSP Switch Setup

A single analyzer and the Rohde & Schwarz OSP Switch Platform (with at least one fitted R&S®OSP-B101 option) is required to measure the number of DUT Tx Antennas as defined in [DUT MIMO configuration](#).

Note: For sequential MIMO measurements the DUT has to transmit identical PPDU's over time! The signal field, for example, has to be identical for all PPDU's.

This setup requires the analyzer and the OSP switch platform to be connected via LAN. A connection diagram is shown to assist you in connecting the specified number of DUT Tx antennas with the analyzer via the Rohde & Schwarz OSP switch platform.

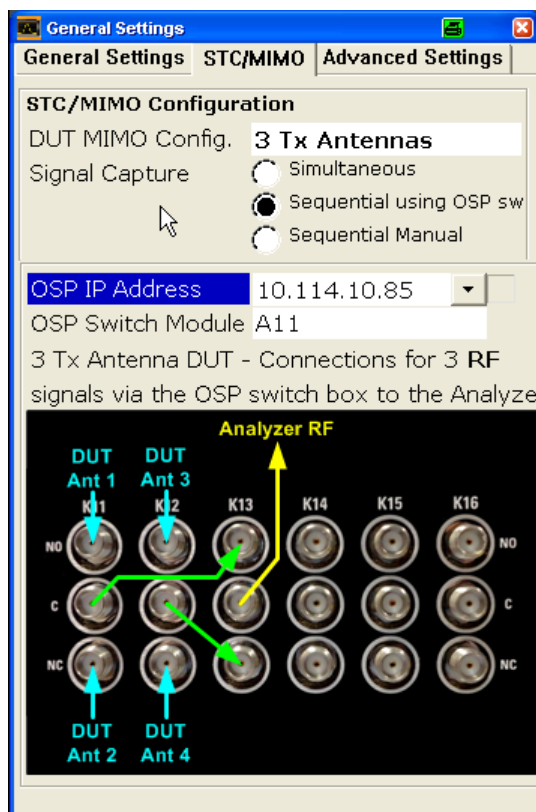

Fig. 4-3: Connection instructions for sequential MIMO using an OSP switch

The diagram shows an R&S®OSP-B101 option fitted in one of the three module slots at the rear of the OSP switch platform. The DUT Tx antennas, the OSP switching box and the analyzer have to be connected as indicated in the diagram.

- **Blue** colored arrows represent the connections between the Tx antennas of the DUT and the corresponding SMA plugs of the R&S®OSP-B101 option.
- **Green** colored arrows represent auxiliary connections of SMA plugs of the R&S®OSP-B101 option.
- **Yellow** colored arrows represent the connection between the SMA plug of the R&S®OSP-B101 option with the RF or analog baseband input of the analyzer.

OSP IP Address ← Sequential Using OSP Switch Setup

The analyzer and the R&S OSP switch platform have to be connected via LAN. Enter the IP address of the OSP switch platform.

When using an R&S®OSP130 switch platform, the IP address is shown in the front display.

When using a R&S®OSP120 switch platform, connect an external monitor to get the IP address or use the default IP address of the OSP switch platform. For details read the OSP operation manual.

An online keyboard is displayed to enter the address in dotted IPV4 format.

Remote command:

[CONFigure:WLAN:OSP:ADDRes](#)s on page 160

OSP Switch Module ← Sequential Using OSP Switch Setup

The R&S®OSP-B101 option is fitted in one of the three module slots at the rear of the OSP switch platform. The DUT Tx antennas are connected with the analyzer via the R&S®OSP-B101 module fitted in the OSP switch platform. Select the R&S®OSP-B101 module that is used for this connection.

Remote command:

[CONFigure:WLAN:OSP:MODule](#) on page 160

Manual Sequential MIMO Data Capture

Note: For sequential MIMO measurements the DUT has to transmit identical PPDU's over time! The signal field, for example, has to be identical for all PPDU's. Otherwise, manual data capture will not return reasonable measurement results.

For this MIMO method you must connect each Tx antenna of the WLAN DUT with the analyzer and start data capturing manually (see "Capture" on page 96).

The dialog box shows a preview of the 4 capture memories (one for each RX antenna). The PPDU's detected by the application are highlighted by the green bars.

Remote command:

```
CONF:WLAN:MIMO:CAPT:TYP MAN
CONF:WLAN:MIMO:CAPT RX1
INIT:IMM
CALC:BURS:IMM
```

Capture ← Manual Sequential MIMO Data Capture

For each Rx antenna the contents of the capture memory are displayed. Press the "Capture" button for the corresponding antenna to start a new data capture.

Remote command:

[INITiate<n>\[:IMMediate\]](#) on page 177

Analyze ← Manual Sequential MIMO Data Capture

Calculates the results for the captured antenna signals.

Remote command:

`CALCulate<n>:BURSt[:IMMediate]` on page 120

Clear ← Manual Sequential MIMO Data Capture

Clears all the capture memory previews.

4.3 Demod Settings Dialog Box

In the "Demod Settings" dialog box, the settings associated with the signal modulation can be modified. The settings under "PPDU to Analyze" specify the characteristics of the PPDU to be considered in the measurement results. Only the PPDU which meet the criteria specified in this group will be included in measurement analysis if the "Use Header Content" option is activated. The tracking settings allow various errors in measurement results to be compensated for.

- [Demod Settings](#).....97
- [Advanced Demod Settings \(IEEE 802.11ac, n \(MIMO\) only\)](#)..... 104
- [MIMO Settings \(IEEE 802.11ac, n \(MIMO\) only\)](#)..... 109

4.3.1 Demod Settings

Demod Settings (IEEE 802.ac, n (MIMO) only)	98
Signal Field Content (IEEE 802.11a, g (OFDM), j & n (SISO), p)	98
Use Header Content (IEEE 802.11b, g – Single Carrier)	98
PPDU Type (IEEE 802.11a, g (OFDM, Single Carrier), j, n, p)	98
Preamble Type (IEEE 802.11b)	99
PPDU Frame Format (IEEE 802.11n, SISO)	99
Auto Demodulation (IEEE 802.11n, SISO)	99
Analyze PSDU Mod (IEEE 802.11n, SISO)	99
Demodulator (IEEE 802.11a, b, g, j, p)	100
Auto Guard Interval (IEEE 802.11n, SISO)	100
Guard Interval (IEEE 802.11n, SISO)	100
Equal PPDU Length	100
Data Symbols (IEEE 802.11a, ac, j, n, p)	101
Min Data Symbols (IEEE 802.11a, ac, j, n, p)	101
Max Data Symbols (IEEE 802.11a, ac, j, n, p)	101
Channel Estimation Range (IEEE 802.11a, ac, g (OFDM), j, n, p)	101
Payload Length (IEEE 802.11b, g)	102
Min Payload Length (IEEE 802.11b, g)	102
Max Payload Length (IEEE 802.11b, g)	102
Filter adjacent channels (IEEE 802.11ac, n (MIMO))	102
Phase	102
Timing	102
Level	103
Pilots for Tracking (IEEE 802.11n, ac (SISO+MIMO))	103

Filters (IEEE 802.11b, g).....	103
L Transmit Filter.....	103
L Receive Filter.....	103
L Equalizer Filter Len.	104
FFT Start Offset (IEEE 802.11a, g, j, p).....	104

Demod Settings (IEEE 802.ac, n (MIMO) only)

Determines whether the settings are defined automatically or manually.

"Auto All" Automatically sets all Advanced demodulation settings to "Auto, same as first PPDU".

"Manual" Restores all settings to the state prior to activating "Auto All".

Remote command:

[SENSe:] DEMod: FORMat [: BCONtent] : AUTO on page 193

Signal Field Content (IEEE 802.11a, g (OFDM), j & n (SISO), p)

Activates or deactivates the decoding of the captured PPDU data.

"ON" Only the PPDUs are included in the results analysis whose modulation format specified in the signal symbol field matches the modulation format specified in the "Analyze PSDU Mod (IEEE 802.11n, SISO)" on page 99 field.

"OFF" The data is demodulated according to the modulation scheme specified in the "Demodulator (IEEE 802.11a, b, g, j, p)" on page 100 field. If any of the analyzed data has a modulation different to that specified the results will be of limited use.

Remote command:

[SENSe:] DEMod: FORMat : SIGSymbol on page 196

Use Header Content (IEEE 802.11b, g – Single Carrier)

Activates or deactivates the PLCP header field decoding of the captured PPDU data.

"ON" Only the PPDUs are included in the results analysis whose modulation format specified in the signal symbol field matches the modulation format specified in the "Analyze PSDU Mod (IEEE 802.11n, SISO)" on page 99 field.

"OFF" The data is demodulated according to the modulation scheme specified in the "Demodulator (IEEE 802.11a, b, g, j, p)" on page 100 field. If any of the analyzed data has a modulation different to that specified the results will be of limited use.

Remote command:

[SENSe:] DEMod: FORMat : SIGSymbol on page 196

PPDU Type (IEEE 802.11a, g (OFDM, Single Carrier), j, n, p)

Specifies the type of PPDU to be included in measurement analysis. Only one PPDU type can be selected for the measurement results. The following PPDU types are supported:

"Direct Link PPDU"	IEEE 802.11a, j, n, p
"OFDM"	IEEE 802.11g
"Long DSSS"->"OFDM"	IEEE 802.11g
"Short DSSS"->"OFDM"	IEEE 802.11g
"Long PLCP"	IEEE 802.11g
"Short PLCP"	IEEE 802.11g

Remote command:

[\[SENSe:\] DEMod:FORMat:BANalyze:BTYPe](#) on page 187

Preamble Type (IEEE 802.11b)

Specifies the type of PPDU which should be included in measurement analysis. The following PPDU types are supported: Short PLCP, Long PLCP.

Remote command:

[\[SENSe:\] DEMod:FORMat:BANalyze:BTYPe](#) on page 187

PPDU Frame Format (IEEE 802.11n, SISO)

Specifies the type of PHY Protocol Data Unit (PPDU) which should be included in measurement analysis. The following PPDU formats are supported:

- Mixed 20MHz
- Green Field 20MHz
- Mixed 40MHz
- Green Field 40MHz

Remote command:

[\[SENSe:\] DEMod:FORMat:BANalyze:BTYPe](#) on page 187

Auto Demodulation (IEEE 802.11n, SISO)

Activates or deactivates the automatic detection of the modulation. If activated, the modulation applied to the input data is determined from the modulation type of the first complete PPDU within the captured data. This option automatically activates the "Signal Field Content" option.

Remote command:

[\[SENSe:\] DEMod:FORMat\[:BContent\]:AUTO](#) on page 193

Analyze PSDU Mod (IEEE 802.11n, SISO)

Specifies the modulation of the PDUs to be analyzed. Only PDUs using the selected modulation are considered in measurement analysis. This option is only available if the "Use Signal Field Content" or the "Use Header Content" option is activated.

Remote command:

[\[SENSe:\] DEMod:FORMat:BANalyze](#) on page 187

Demodulator (IEEE 802.11a, b, g, j, p)

Specifies the modulation to be applied to the measured data. If the captured data uses a different modulation scheme than specified by this field the results will be of limited use. This field is only available if the "Signal Field Content" or the "Use Header Content" option is deactivated.

Remote command:

[\[SENSe:\]DEMod:FORMat:BANalyze](#) on page 187

Auto Guard Interval (IEEE 802.11n, SISO)

Specifies whether the Guard interval of the measured data should be automatically detected or not

If enabled, the Guard Interval is detected from the input signal.

If disabled, the guard interval of the input signal can be specified with the "Guard Interval" parameter.

Remote command:

[CONFigure:WLAN:GTIME:AUTO](#) on page 157

Guard Interval (IEEE 802.11n, SISO)

Specifies the guard interval of the input signal.

When "Auto Guard Interval" is set to "ON" then "Guard Interval" is read only and displays the detected guard interval.

"Short" Only the PPDU's with short guard interval are analyzed.

"Long" Only the PPDU's with long guard interval are analyzed.

Remote command:

[CONFigure:WLAN:GTIME:SElect](#) on page 158

Equal PPDU Length

Activates or deactivates the PPDU selection for measurement analysis according to the range or specific number of data symbols/bytes.

Standard	State	Description
IEEE 802.11a, ac, j, n, p	On	Only PPDU's with exactly the number of symbols specified in the "Data Symbols" field are considered for measurement analysis (see "Data Symbols (IEEE 802.11a, ac, j, n, p)" on page 101).
	Off	Only PPDU's within the range of data symbols specified by the "Min Data Symbols" and "Max Data Symbols" fields are considered for measurement analysis. (See "Min Data Symbols (IEEE 802.11a, ac, j, n, p)" on page 101 and "Max Data Symbols (IEEE 802.11a, ac, j, n, p)" on page 101)
IEEE 802.11b, g (Single Carrier)	On	Only PPDU's with exactly the number of data bytes or duration specified in the "Payload Length" field are considered for measurement analysis. (See "Payload Length (IEEE 802.11b, g)" on page 102)
	Off	Only PPDU's within the range of data bytes or duration specified by the "Min Payload Length" and "Max Payload Length" fields are considered for measurement analysis. (See "Min Payload Length (IEEE 802.11b, g)" on page 102 and "Max Payload Length (IEEE 802.11b, g)" on page 102)

Standard	State	Description
IEEE 802.11g (OFDM)	On	Only PPDU with exactly the number of data symbols or duration specified in the "Payload Length" field are considered for measurement analysis. (See "Payload Length (IEEE 802.11b, g)" on page 102)
	Off	Only PPDU within the range of data symbols or duration specified by the "Min Payload Length" and "Max Payload Length" fields are considered for measurement analysis. (See "Min Payload Length (IEEE 802.11b, g)" on page 102 and "Max Payload Length (IEEE 802.11b, g)" on page 102)

Remote command:

[\[SENSe:\] DEMod:FORMat:BANalyze:SYMBOLs:EQUal](#) on page 192

[\[SENSe:\] DEMod:FORMat:BANalyze:DBYTes:EQUal](#) on page 189

[\[SENSe:\] DEMod:FORMat:BANalyze:DURation:EQUal](#) on page 191

Data Symbols (IEEE 802.11a, ac, j, n, p)

Specifies the number of data symbols of a PPDU to be considered in measurement analysis. This field is only available if the "Equal PPDU Length" option is activated.

Remote command:

[\[SENSe:\] DEMod:FORMat:BANalyze:SYMBOLs:MIN](#) on page 193

Min Data Symbols (IEEE 802.11a, ac, j, n, p)

Specifies the minimum number of data symbols of a PPDU to be considered in measurement analysis. This field is only available if the "Equal PPDU Length" option is deactivated.

Remote command:

[\[SENSe:\] DEMod:FORMat:BANalyze:SYMBOLs:MIN](#) on page 193

Max Data Symbols (IEEE 802.11a, ac, j, n, p)

Specifies the maximum number of data symbols of a PPDU to be considered in measurement analysis. This field is only available if the "Equal PPDU Length" option is deactivated.

Remote command:

[\[SENSe:\] DEMod:FORMat:BANalyze:SYMBOLs:MAX](#) on page 192

Channel Estimation Range (IEEE 802.11a, ac, g (OFDM), j, n, p)

Specifies how accurately the EVM results are calculated.

"Preamble"	The channel estimation is performed in the preamble as required in the standard.
"Payload"	The channel estimation is performed in the payload.

Remote command:

[\[SENSe:\] DEMod:CESTimation](#) on page 185

Payload Length (IEEE 802.11b, g)

Specifies the number of symbols, bytes or duration of a PPDU to be considered in measurement analysis. This field is only available if the "Equal PPDU Length" option is activated.

Remote command:

[\[SENSe:\]DEMod:FORMat:BANalyze:DBYTeS:MIN](#) on page 190

[\[SENSe:\]DEMod:FORMat:BANalyze:DURation:MIN](#) on page 191

Min Payload Length (IEEE 802.11b, g)

Specifies the minimum number of symbols, bytes or duration of a PPDU to be considered in measurement analysis. This field is only available if the "Equal PPDU Length" option is deactivated.

Remote command:

[\[SENSe:\]DEMod:FORMat:BANalyze:DBYTeS:MIN](#) on page 190

[\[SENSe:\]DEMod:FORMat:BANalyze:DURation:MIN](#) on page 191

Max Payload Length (IEEE 802.11b, g)

Specifies the maximum number of symbols, bytes or duration of a PPDU to be considered in measurement analysis. This field is only available if the "Equal PPDU Length" option is deactivated.

Remote command:

[\[SENSe:\]DEMod:FORMat:BANalyze:DBYTeS:MAX](#) on page 190

[\[SENSe:\]DEMod:FORMat:BANalyze:DURation:MAX](#) on page 191

Filter adjacent channels (IEEE 802.11ac, n (MIMO))

If activated, only the useful signal is analyzed, all signal data in adjacent channels is filtered out by the RBW filter.

This setting improves the signal to noise ratio and thus the EVM results for narrow signals.

Remote command:

[\[SENSe:\]BANDwidth\[:RESolution\]:FILTer](#) on page 184

Phase

Activates or deactivates the compensation for phase error. If activated, the measurement results are compensated for phase error on a per-symbol basis.

Remote command:

[\[SENSe:\]TRACking:PHASe](#) on page 203

Timing

Activates or deactivates the compensation for timing error. If activated, the measurement results are compensated for timing error on a per-symbol basis.

Remote command:

[\[SENSe:\]TRACking:TIME](#) on page 204

Level

Activates or deactivates the compensation for level error. If activated, the measurement results are compensated for level error on a per-symbol basis.

Remote command:

[\[SENSe:\] TRACking:LEVel](#) on page 203

Pilots for Tracking (IEEE 802.11n, ac (SISO+MIMO))

In case tracking is used, the used pilot sequence has an effect on the measurement results.

"According to standard" The pilot sequence is determined according to the corresponding WLAN standard. In case the pilot generation algorithm of the device under test (DUT) has a problem, the erroneous pilot sequence might affect the measurement results or the WLAN measurement application might not synchronize at all onto the signal generated by the DUT.

"Detected" The pilot sequence detected in the WLAN signal to be analyzed is used by the WLAN measurement application. In case the pilot generation algorithm of the device under test (DUT) has a problem, the erroneous pilot sequence will not affect the measurement results. In case the pilot sequence generated by the DUT is correct, it is recommended that you use the "According to Standard" setting because it generates more accurate measurement results.

Remote command:

[\[SENSe:\] TRACking:PILots](#) on page 204

Filters (IEEE 802.11b, g)

Filter settings are only available for standards IEEE 802.11b, g.

Transmit Filter ← Filters (IEEE 802.11b, g)

Specifies the transmit filter to be used

The settings provided by default are:

- Auto – Specifies the default filter
- DefRecieve – default receive filter
- DefTransimt – default transmit filter

See also [chapter 3.4, "Signal Processing of the IEEE 802.11b Application"](#), on page 29

Remote command:

[\[SENSe:\] DEMod:FILTer:MODulation](#) on page 187

Receive Filter ← Filters (IEEE 802.11b, g)

Specifies the receive filter to be used

The settings provided by default are:

- Auto – Specifies the default filter
- DefRecieve – default receive filter
- DefTransimt – default transmit filter

See also [chapter 3.4, "Signal Processing of the IEEE 802.11b Application"](#), on page 29

Remote command:

[\[SENSe:\]DEMod:FILTer:MODulation](#) on page 187

Equalizer Filter Len. ← Filters (IEEE 802.11b, g)

Specifies the length of the equalizer filter in chips

Remote command:

[\[SENSe:\]DEMod:FILTer:EFLength](#) on page 186

FFT Start Offset (IEEE 802.11a, g, j, p)

This command specifies the FFT start offset.

- "AUTO" The FFT start offset is automatically chosen to minimize the intersymbol interference.
- "Guard Interval Cntr" Guard Interval Center: The FFT start offset is placed to the center of the guard interval.
- "Peak" The peak of the fine timing metric is used to determine the FFT start offset.

Remote command:

[\[SENSe:\]DEMod:FFT:OFFSet](#) on page 186

4.3.2 Advanced Demod Settings (IEEE 802.11ac, n (MIMO) only)

The Advanced Demod settings allow you to specify the PPDU's to be analyzed. It also provides settings to adapt the synchronisation to the channel conditions.

This tab is only available if the standard IEEE 802.11ac or n (MIMO) is selected.

PPDU format to measure	104
Channel Bandwidth to measure	105
MCS Index to use	105
MCS Index	106
Nsts to use (IEEE 802.11 ac only)	106
Nsts (IEEE 802.11ac only)	106
STBC field	106
Guard Interval Length	107
Extension spatial streams (sounding) (IEEE 802.11ac or n (MIMO) only)	108
Source of Payload Length	108
Power Interval Search (IEEE 802.11ac only)	108
FFT Start Offset	108

PPDU format to measure

Defines the PPDU formats included in the analysis.

- "Auto, same type as first PPDU" All PPDU's identical to the first recognized PPDU are analyzed.

"Auto, individually for each PDU"	All PPDUs are analyzed
"Meas only Mixed Mode"	Only mixed mode PPDUs are analyzed
"Meas only Greenfield"	Only Greenfield mode PPDUs are analyzed.
"Demod all as Mixed Mode"	All PPDUs are analyzed as Mixed Mode PPDUs
"Demod all as Greenfield"	All PPDUs are analyzed as Greenfield PPDUs.

Remote command:

[\[SENSe:\]DEMod:FORMat:BANalyze:BTYPe:AUTO:TYPE](#) on page 188

Channel Bandwidth to measure

Defines the channel bandwidth of the PPDUs taking part in the analysis.

"Auto, same type as first PDU"	The channel bandwidth of the first valid PPDUs is detected and subsequent PPDUs are analyzed only if they have the same channel bandwidth.
"Auto, individually for each PDU"	All PPDUs are analyzed regardless of their channel bandwidth
"Meas only x MHz signal:"	Only PPDUs with a channel bandwidth of x MHz are analyzed
"Demod all as x MHz signal:"	All PPDUs are analyzed as x MHz channel bandwidth PPDUs.

Remote command:

[\[SENSe:\]BANDwidth:CHANnel:AUTO:TYPE](#) on page 183

MCS Index to use

Defines the Modulation and Coding Scheme (MCS) index of the PPDUs taking part in the analysis.

"Auto, same type as first PDU:"	All PPDUs using the MCS index identical to the first recognized PDU are analyzed.
" Auto, individually for each PDU"	All PPDUs are analyzed
"Meas only the specified MCS"	Only PPDUs with the MCS index specified in the MCS index field are analyzed
"Demod all with specified MCS"	The MCS index of the MCS index field is applied to all PPDUs.

Remote command:

[\[SENSe:\]DEMod:FORMat:MCSIndex:MODE](#) on page 194

MCS Index

define the Modulation and Coding Scheme (MCS) index, of the PPDU taking part in the analysis, manually. This field is enabled for "MCS index to use" = "Meas only the specified MCS" or "Demod all with specified MCS".

Remote command:

[SENSe:] DEMod: FORMat: MCSIndex on page 194

Nsts to use (IEEE 802.11 ac only)

Defines the the PPDU taking part in the analysis depending on their Nsts.

Note: The terms in brackets in the following description indicate how the setting is referred to in the "Signal Field" result display ("NSTS" column).

"Auto, same type as first PDU""(A1st)" All PPDU using the Nsts identical to the first recognized PDU are analyzed.

" Auto, individually for each PDU""(AI)" All PPDU are analyzed

"Meas only the specified Nsts""(M ...)" Only PPDU with the Nsts specified for the [Nsts \(IEEE 802.11ac only\)](#) setting are analyzed

"Demod all with specified Nsts""(D ...)" The [Nsts \(IEEE 802.11ac only\)](#) setting is used for all PPDU.

Remote command:

[SENSe:] DEMod: FORMat: NSTSindex: MODE on page 195

Nsts (IEEE 802.11ac only)

Defines the Nsts of the PPDU taking part in the analysis. This field is enabled for [Nsts to use \(IEEE 802.11 ac only\)](#) = "Meas only the specified Nsts" or "Demod all with specified Nsts".

Remote command:

[SENSe:] DEMod: FORMat: NSTSindex on page 195

STBC field

Defines the Space-Time Block Coding (STBC) field content of the PPDU taking part in the analysis.

"Auto, same type as first PDU""(A1st)" All PPDU using a STBC field content identical to the first recognized PDU are analyzed.

"Auto, individually for each PDU""(AI)" All PPDU are analyzed.

"Meas only if STBC field = 1 (+1 Stream)""(M1)" (IEEE 802.11N)	Only PPDU's with the specified STBC field content are analyzed.
"Meas only if STBC field = 2 (+2 Stream)""(M2)" (IEEE 802.11N)	Only PPDU's with the specified STBC field content are analyzed.
"Demod all as STBC field = 1""(D1)"(IEEE 802.11N)	All PPDU's are analyzed assuming the specified STBC field content.
"Demod all as STBC field = 2""(D2)"(IEEE 802.11N)	All PPDU's are analyzed assuming the specified STBC field content.
"Meas only if STBC = 1 (Nsts = 2Nss)""(M1)"(IEEE 802.11AC)	Only PPDU's with the specified STBC field content are analyzed.
"Demod all as STBC = 1 (Nsts = 2Nss)""(D1)"(IEEE 802.11AC)	All PPDU's are analyzed assuming the specified STBC field content.

Remote command:

[CONFigure:WLAN:STBC:AUTO:TYPE](#) on page 163

Guard Interval Length

Defines the guard interval length of the PPDU's taking part in the analysis.

"Auto, same type as first PPDU:"	All PPDU's using the guard interval length identical to the first recognized PPDU are analyzed.
"Auto, individually for each PPDU: "	All PPDU's are analyzed.
"Meas only Short"	Only PPDU's with short guard interval length are analyzed.
"Meas only Long"	Only PPDU's with long guard interval length are analyzed.

"Demod all as short" All PPDUs are demodulated assuming short guard interval length.

"Demod all as long " All PPDUs are demodulated assuming long guard interval length.

Remote command:

[CONFigure:WLAN:GTIME:AUTO:TYPE](#) on page 157

Extension spatial streams (sounding) (IEEE 802.11ac or n (MIMO) only)

defines the Ness field content of the PPDUs taking part in the analysis.

"Auto, same type as first PDU" All PPDUs using a Ness value identical to the first recognized PDU are analyzed.

"Auto, individually for each PDU" All PPDUs are analyzed.

"Meas only if Ness = <x>" Only PPDUs with the specified Ness value are analyzed.

"Demod all as Ness = <x>" All PPDUs are analyzed assuming the specified Ness value.

Remote command:

[CONFigure:WLAN:EXTension:AUTO:TYPE](#) on page 156

Source of Payload Length

Defines how the payload length of the PPDUs to analyze is determined.

"Estimate from Signal" The payload length is estimated by the measurement application from the signal.

"Take from HT-SIG" The payload length information from the HT-Signal field is used.

Remote command:

[CONFigure:WLAN:PAYload:LENgth:SRC](#) on page 160

Power Interval Search (IEEE 802.11ac only)

If enabled, the R&S FSV WLAN application initially performs a coarse burst search on the input signal in which increases in the power vs time trace are detected. Further time-consuming processing is then only performed where bursts are assumed. This improves the measurement speed for signals with low duty cycle rates.

However, for signals in which the PDU power levels differ significantly, this option should be disabled as otherwise some PPDUs may not be detected.

Remote command:

[\[SENSe:\] DEMod:TXARea](#) on page 196

FFT Start Offset

This command specifies the FFT start offset.

"AUTO" The FFT start offset is automatically chosen to minimize the intersymbol interference.

"Guard Interval Cntr" Guard Interval Center: The FFT start offset is placed to the center of the guard interval.

Remote command:

[SENSe:] DEMod: FFT: OFFSet on page 186

4.3.3 MIMO Settings (IEEE 802.11ac, n (MIMO) only)

The MIMO settings define the mapping between streams and antennas.

This tab is only available if the standard IEEE 802.11ac or n (MIMO) is selected.

Spatial Mapping Mode.....	109
Power Normalise.....	109
User Defined Spatial Mapping.....	109

Spatial Mapping Mode

Defines the mapping between streams and antennas.

- "Direct" The mapping between streams and antennas is the identity matrix. See also section "20.3.11.10.1 Spatial Mapping" of the IEEE 802.11n WLAN standard.
- "Spatial Expansion:" For this mode all streams contribute to all antennas. See also section "20.3.11.10.1 Spatial Mapping" of the IEEE 802.11n WLAN standard.
- "User defined" The mapping between streams and antennas is defined by the User Defined Spatial Mapping table.

Remote command:

CONFigure: WLAN: SMAPping: MODE on page 161

Power Normalise

Specifies whether an amplification of the signal power due to the spatial mapping is performed according to the matrix entries.

- "On" Spatial mapping matrix is scaled by a constant factor to obtain a passive spatial mapping matrix which does not increase the total transmitted power.
- "Off" Normalization step is omitted

Remote command:

CONFigure: WLAN: SMAPping: NORMAlise on page 162

User Defined Spatial Mapping

Define your own spatial mapping between streams and antennas.

For each antenna (TX1..4), the complex element of each STS-Stream is defined. The upper value is the real part part of the complex element. The lower value is the imaginary part of the complex element.

Additionally, a "Time Shift" can be defined for cyclic delay diversity (CSD).

The stream for each antenna is calculated as:

$$\begin{pmatrix} Tx_1 - Stream \\ \cdot \\ \cdot \\ Tx_4 - Stream \end{pmatrix} = \begin{pmatrix} Tx_1, STS.1 & \cdot & \cdot & Tx_1, STS.4 \\ \cdot & & & \cdot \\ \cdot & & & \cdot \\ Tx_4, STS.1 & \cdot & \cdot & Tx_4, STS.4 \end{pmatrix} \begin{pmatrix} STS - Stream_1 \\ \cdot \\ \cdot \\ STS - Stream_4 \end{pmatrix}$$

Remote command:

[CONFigure:WLAN:SMAPping:TX<1...4>](#) on page 162

[CONFigure:WLAN:SMAPping:TX<1...4>:STReam<1...4>](#) on page 162

[CONFigure:WLAN:SMAPping:TX<1...4>:TIMeshift](#) on page 163

4.4 Softkeys of the Sweep Menu – SWEEP key

The following table shows all softkeys available in the "Sweep" menu in "WLAN" mode (SWEEP key). It is possible that your instrument configuration does not provide all softkeys. If a softkey is only available with a special option, model or (measurement) mode, this information is delivered in the corresponding softkey description.

Run Single/Cont	110
Auto Level	110
Refresh	110

Run Single/Cont

Selects the sweep mode.

"Single" single sweep mode

"Cont" continuous sweep mode

Remote command:

[INITiate<n>:CONTinuous](#) on page 176

Auto Level

Starts an automatic level detection measurement. If this softkey is pressed while a measurement is running, the current measurement is aborted and the automatic level detection measurement is started. If the aborted measurement was a continuous measurement it is resumed after the automatic level detection is completed.

Remote command:

[CONFigure:POWer:AUTO](#) on page 153

Refresh

Updates the current measurement results with respect to the current gate settings. This softkey is only available if the measurement results are effected by the gate settings (Spectrum FFT, PVT and CCDF) and if the gate settings are modified after a measurement result has been obtained.

4.5 Softkeys of the Trace Menu – TRAC key

The following table shows all softkeys available in the "Trace" menu in "WLAN" mode (TRACE key). It is possible that your instrument configuration does not provide all softkeys. If a softkey is only available with a special option, model or (measurement) mode, this information is delivered in the corresponding softkey description.

Display List/Graph

Configures the result display. The measurement results are displayed either in form of a list of measurement points or as a graphical trace.

For MIMO measurements (IEEE 802.11ac or n (MIMO) only) the results are provided as an overview of all data streams in the Global Result Summary (List 1), and for the individual streams in separate result summaries (List 2).

Remote command:

`DISPlay[:WINDow<n>]:TABLE` on page 165

For result queries see [chapter 5.8, "FETCh Subsystem \(WLAN\)"](#), on page 168

Screen Focus A/B

Selects the active screen for IQ measurement results in split and full screen mode. Only the markers of an active screen can be controlled.

Remote command:

`DISPlay[:WINDow<n>]:SSElect` on page 164

Screen Size Full/Split

Changes the display between split and full screen for IQ measurement results. Frequency sweep measurement results are always displayed in full screen.

Remote command:

`DISPlay[:WINDow<n>][:SUBWindow<m>]:SIZE` on page 164

4.6 Softkeys of the Marker Menu – MKR key (WLAN)

The following table shows all softkeys available in the "Marker" menu in "WLAN" mode (MKR key). It is possible that your instrument configuration does not provide all softkeys. If a softkey is only available with a special option, model or (measurement) mode, this information is delivered in the corresponding softkey description. Close all settings dialog boxes before opening the "Marker" menu.

Marker 1

Opens a dialog box to adjust the marker. The contents of the dialog box depend on the type of graph the marker is adjusted to. After every change, the marker position in the trace and the marker information are updated.

Remote command:

[CALCulate<n>:MARKer<m>\[:STATe\]](#) on page 139

[CALCulate<n>:MARKer<1>:X](#) on page 142

[CALCulate<n>:MARKer<1>:Y](#) on page 143

[CALCulate<n>:MARKer<1>:SYMBOL](#) on page 141

[CALCulate<n>:MARKer<1>:CARRIER](#) on page 140

Unzoom

Cancels the marker zoom.

Remote command:

[CALCulate<n>:MARKer<1>:FUNCTION:ZOOM](#) on page 145

Marker Zoom

Opens an edit dialog box to select the magnification factor for the zoom. The zoom facility is provided for the following result displays: Magnitude Capture Buffer, PVT, Constellation vs Symbol, Constellation vs Carrier. The maximum magnification depends on the type of result display.

Remote command:

[CALCulate<n>:MARKer<1>:FUNCTION:ZOOM](#) on page 145

Marker Off

Switches off all markers in the active result display.

Remote command:

[CALCulate<n>:MARKer<m>:AOFF](#) on page 139

4.7 Softkeys of the Marker To Menu – MKR-> key

The following table shows all softkeys available in the "Marker To" menu in "WLAN" mode (MKR-> key). It is possible that your instrument configuration does not provide all softkeys. If a softkey is only available with a special option, model or (measurement) mode, this information is delivered in the corresponding softkey description.

Peak (Spectrum Flatness result display)

Sets the marker to the peak value of the assigned trace.

Remote command:

[CALCulate<n>:MARKer<1>:MAXimum](#) on page 141

Min (Spectrum Flatness result display)

Sets the marker to the minimum value of the assigned trace.

Remote command:

[CALCulate<n>:MARKer<1>:MINimum](#) on page 141

MKR -> Trace

Opens an edit dialog box to enter the number of the trace, on which the marker is to be placed. This softkey is available for all result displays with more than one trace.

Remote command:

[CALCulate<n>:MARKer<1>:TRACe](#) on page 142

4.8 Softkeys of the Lines Menu – LINES key

The following table shows all softkeys available in the "Lines" menu in "WLAN" mode (LINES key). It is possible that your instrument configuration does not provide all softkeys. If a softkey is only available with a special option, model or (measurement) mode, this information is delivered in the corresponding softkey description.

This menu is only available if the results are displayed in form of a list (for details see [chapter 3.9.2, "Result Summary List"](#), on page 54 and the "Display Graph/List" softkey, "Display List/Graph" on page 64).

Default Current	113
Default All	113

Default Current

Resets all limits for the current modulation scheme to the values specified in the selected standard.

Remote command:

[chapter 5.4, "CALCulate:LIMit Subsystem \(WLAN\)"](#), on page 121

Default All

Resets all limits for all modulation schemes to the values specified in the selected standard.

Remote command:

[chapter 5.4, "CALCulate:LIMit Subsystem \(WLAN\)"](#), on page 121

4.9 Softkeys of the Input/Output Menu for WLAN Measurements

The following chapter describes all softkeys available in the "Input/Output" menu for WLAN measurements.

Note that the digital baseband functions are only available if the optional Digital Baseband Interface (R&S FSV-B17) is installed.

For details see the base unit description.

EXIQ	114
L TX Settings	114
L RX Settings	114
L Send To	114

L Firmware Update.....	114
L R&S Support.....	114
L DigIConf.....	115

EXIQ

Opens a configuration dialog box for an optionally connected R&S EX-IQ-BOX and a submenu to access the main settings quickly.

Note: The EX-IQ-Box functionality is not supported for R&S FSV models 1321.3008Kxx.

If the optional R&S DigIConf software is installed, the submenu consists only of one key to access the software. **Note that R&S DigIConf requires a USB connection (not LAN!) from the R&S FSV to the R&S EX-IQ-BOX in addition to the R&S Digital I/Q Interface connection. R&S DigIConf version 2.10 or higher is required.**

For typical applications of the R&S EX-IQ-BOX see also the description of the R&S Digital I/Q Interface (R&S FSV-B17) in the base unit manual.

For details on configuration see the "R&S®Ex I/Q Box - External Signal Interface Module Manual".

For details on installation and operation of the R&S DigIConf software, see the "R&S®EX-IQ-BOX Digital Interface Module R&S®DigIConf Software Operating Manual".

TX Settings ← EXIQ

Opens the "EX-IQ-BOX Settings" dialog box to configure the R&S FSV for digital output to a connected device ("Transmitter" Type).

RX Settings ← EXIQ

Opens the "EX-IQ-BOX Settings" dialog box to configure the R&S FSV for digital input from a connected device ("Receiver" Type).

Send To ← EXIQ

The configuration settings defined in the dialog box are transferred to the R&S EX-IQ-BOX.

Firmware Update ← EXIQ

If a firmware update for the R&S EX-IQ-BOX is delivered with the R&S FSV firmware, this function is available. In this case, when you select the softkey, the firmware update is performed.

R&S Support ← EXIQ

Stores useful information for troubleshooting in case of errors.

This data is stored in the `C:\R_S\Instr\user\Support` directory on the instrument.

If you contact the Rohde&Schwarz support to get help for a certain problem, send these files to the support in order to identify and solve the problem faster.

DigIConf ← EXIQ

Starts the optional R&S DigIConf application. This softkey is only available if the optional software is installed.

To return to the R&S FSV application, press any key on the front panel. The application is displayed with the "EXIQ" menu, regardless of which key was pressed.

For details on the R&S DigIConf application, see the "R&S®EX-IQ-BOX Digital Interface Module R&S®DigIConf Software Operating Manual".

Note: If you close the R&S DigIConf window using the "Close" icon, the window is minimized, not closed.

If you select the "File > Exit" menu item in the R&S DigIConf window, the application is closed. Note that in this case the settings are lost and the EX-IQ-BOX functionality is no longer available until you restart the application using the "DigIConf" softkey in the R&S FSV once again.

Remote command:

Remote commands for the R&S DigIConf software always begin with `SOURce:EBOX`. Such commands are passed on from the R&S FSV to the R&S DigIConf automatically which then configures the R&S EX-IQ-BOX via the USB connection.

All remote commands available for configuration via the R&S DigIConf software are described in the "R&S®EX-IQ-BOX Digital Interface Module R&S®DigIConf Software Operating Manual".

Example 1:

```
SOURce:EBOX:*RST
```

```
SOURce:EBOX:*IDN?
```

Result:

```
"Rohde&Schwarz,DigIConf,02.05.436 Build 47"
```

Example 2:

```
SOURce:EBOX:USER:CLOCK:REFERENCE:FREQUENCY 5MHZ
```

Defines the frequency value of the reference clock.

5 Remote Commands for WLAN TX Measurements

This section describes the remote commands specific to the WLAN TX Measurements option (R&S FSV-K91/91n/91ac/91p). The abbreviation WLAN stands for the Wireless LAN operating mode. For details on conventions used in this chapter refer to [chapter 5.1, "Notation"](#), on page 117 at the beginning of this chapter.

For further information on analyzer or basic settings commands, refer to the corresponding subsystem in the base unit description.

Subsystems of the WLAN TX Measurements option

5.1	Notation	117
5.2	ABORt Subsystem	120
5.3	CALCulate:BURSt Subsystem (WLAN)	120
5.4	CALCulate:LIMit Subsystem (WLAN)	121
5.5	CALCulate:MARKer Subsystem (WLAN)	138
5.5.1	Description of the CALCulate:MARKer Subsystem (WLAN, R&S FSV K91/91n).....	139
5.5.2	CALCulate:MARKer:FUNCTion Subsystem (WLAN, R&S FSV-K91/91n).....	144
5.6	CONFIgure Subsystem (WLAN)	145
5.7	DISPlay Subsystem (WLAN)	163
5.8	FETCh Subsystem (WLAN)	168
5.8.1	ASCIi formats for returned values.....	168
5.8.2	Commands of the Fetch Subsystem (K91).....	169
5.9	FORMat Subsystem	176
5.10	INITiate Subsystem	176
5.11	INPut Subsystem	177
5.12	INSTrument Subsystem (WLAN)	179
5.13	MMEMory Subsystem (WLAN)	179
5.14	SENSE Subsystem (WLAN)	181
5.14.1	Analysis modulation format.....	181
5.14.2	Commands of the SENSE Subsystem.....	182
5.15	STATus Subsystem (WLAN)	204
5.16	TRACe Subsystem (WLAN)	208
5.16.1	Commands of the TRACe Subsystem.....	209
5.16.2	I/Q Measurements.....	211

5.16.3	Power vs Time – Full Burst and Rising/Falling Data.....	212
5.16.4	Spectrum Flatness.....	212
5.16.5	Spectrum Flatness 11n.....	213
5.16.6	Spectrum Group Delay 11n.....	213
5.16.7	Spectrum FFT.....	214
5.16.8	Statistics Bitstream Data.....	214
5.16.9	Statistics CCDF – Complementary Cumulative Distribution Function.....	214
5.16.10	Statistics Signal Field Data.....	215
5.16.11	EVM vs Carrier.....	215
5.16.12	EVM vs Symbol.....	215
5.16.13	Error vs Preamble.....	216
5.16.14	Frequency Sweep Measurements.....	216
5.16.15	Spectrum ACPR.....	216
5.17	TRIGger Subsystem (WLAN).....	217
5.18	UNIT Subsystem (K91).....	220
5.19	Status Reporting System (Option R&S FSV-K91).....	221
5.19.1	STATus:OPERation Register.....	224
5.19.2	STATus:QUEStionable Register.....	224
5.19.3	STATus:QUEStionable:LIMit Register.....	225
5.19.4	STATus:QUEStionable:SYNC Register.....	226
5.19.5	STATus:QUEStionable:ACPLimit Register.....	227

5.1 Notation

In the following sections, all commands implemented in the instrument are first listed and then described in detail, arranged according to the command subsystems. The notation is adapted to the SCPI standard. The SCPI conformity information is included in the individual description of the commands.

Individual Description

The individual description contains the complete notation of the command. An example for each command, the *RST value and the SCPI information are included as well.

The options and operating modes for which a command can be used are indicated by the following abbreviations:

Abbreviation	Description
A	spectrum analysis
A-F	spectrum analysis – span > 0 only (frequency mode)
A-T	spectrum analysis – zero span only (time mode)
ADEMODO	analog demodulation (option R&S FSV-K7)
BT	Bluetooth (option R&S FSV-K8)
CDMA	CDMA 2000 base station measurements (option R&S FSV-K82)
EVDO	1xEV-DO base station analysis (option R&S FSV-K84)
GSM	GSM/Edge measurements (option R&S FSV-K10)
IQ	IQ Analyzer mode
OFDM	WiMAX IEEE 802.16 OFDM measurements (option R&S FSV-K93)
OFDMA/WiBro	WiMAX IEEE 802.16e OFDMA/WiBro measurements (option R&S FSV-K93)
NF	Noise Figure measurements (R&S FSV-K30)
PHN	Phase Noise measurements (R&S FSV-K40)
PSM	Power Sensor measurements (option R&S FSV-K9)
SFM	Stereo FM measurements (option R&S FSV-K7S)
SPECM	Spectrogram mode (option R&S FSV-K14)
TDS	TD-SCDMA base station / UE measurements (option R&S FSV-K76/K77)
VSA	Vector Signal Analysis (option R&S FSV-K70)
WCDMA	3GPP Base Station measurements (option R&S FSV-K72), 3GPP UE measurements (option R&S FSV-K73)
WLAN	WLAN TX measurements (option R&S FSV-K91)



The spectrum analysis mode is implemented in the basic unit. For the other modes, the corresponding options are required.

Upper/Lower Case Notation

Upper/lower case letters are used to mark the long or short form of the key words of a command in the description. The instrument itself does not distinguish between upper and lower case letters.

Special Characters

	A selection of key words with an identical effect exists for several commands. These keywords are indicated in the same line; they are separated by a vertical stroke. Only one of these keywords needs to be included in the header of the command. The effect of the command is independent of which of the keywords is used.
--	---

Example:

```
SENSe:FREQuency:CW|:FIXed
```

The two following commands with identical meaning can be created. They set the frequency of the fixed frequency signal to 1 kHz:

```
SENSe:FREQuency:CW 1E3
```

```
SENSe:FREQuency:FIXed 1E3
```

A vertical stroke in parameter indications marks alternative possibilities in the sense of "or". The effect of the command differs, depending on which parameter is used.

Example: Selection of the parameters for the command

```
[SENSe<1...4>:]AVERAge<1...4>:TYPE VIDEo | LINear
```

[]	Key words in square brackets can be omitted when composing the header. The full command length must be accepted by the instrument for reasons of compatibility with the SCPI standards. Parameters in square brackets can be incorporated optionally in the command or omitted as well.
----	---

{}	Parameters in braces can be incorporated optionally in the command, either not at all, once or several times.
----	---

Description of Parameters

Due to the standardization, the parameter section of SCPI commands consists always of the same syntactical elements. SCPI has therefore specified a series of definitions, which are used in the tables of commands. In the tables, these established definitions are indicated in angled brackets (<...>) and is briefly explained in the following.

For details see the chapter "SCPI Command Structure" in the base unit description.

<Boolean>

This keyword refers to parameters which can adopt two states, "on" and "off". The "off" state may either be indicated by the keyword OFF or by the numeric value 0, the "on" state is indicated by ON or any numeric value other than zero. Parameter queries are always returned the numeric value 0 or 1.

<numeric_value> <num>

These keywords mark parameters which may be entered as numeric values or be set using specific keywords (character data). The following keywords given below are permitted:

- MAXimum: This keyword sets the parameter to the largest possible value.
- MINimum: This keyword sets the parameter to the smallest possible value.
- DEFault: This keyword is used to reset the parameter to its default value.
- UP: This keyword increments the parameter value.
- DOWN: This keyword decrements the parameter value.

The numeric values associated to MAXimum/MINimum/DEFault can be queried by adding the corresponding keywords to the command. They must be entered following the quotation mark.

Example:

```
SENSe:FREQuency:CENTer? MAXimum
```

Returns the maximum possible numeric value of the center frequency as result.

<arbitrary block program data>

This keyword is provided for commands the parameters of which consist of a binary data block.

5.2 ABORt Subsystem

ABORt

This command aborts a current measurement and resets the trigger system.

Example: ABOR; INIT: IMM

Mode: all

5.3 CALCulate:BURSt Subsystem (WLAN)

The CALCulate:BURSt subsystem checks the I/Q measurement results.

[CALCulate<n>:BURSt\[:IMMEDIATE\]](#)..... 120

CALCulate<n>:BURSt[:IMMEDIATE]

This command forces the I/Q measurement results to be recalculated according to the current settings.

Suffix:

<n> 1...4
irrelevant

Example: CALC1: BURS
Starts the recalculation of the IQ measurement results.

Usage: Event

Mode: WLAN

Manual operation: See "[Analyze](#)" on page 97

5.4 CALCulate:LIMit Subsystem (WLAN)

The CALCulate:LIMit subsystem contains commands for the limit lines and the corresponding limit checks.

CALCulate<n>:LIMit<1>:ACPower:ACHannel?	122
CALCulate<n>:LIMit<k>:ACPower:ACHannel:RESult	122
CALCulate<n>:LIMit<1>:ACPower:ALternate?	123
CALCulate<n>:LIMit<k>:ACPower:ALternate<channel>[:RELative]	123
CALCulate<n>:LIMit<1>:BURSt:ALL	124
CALCulate<n>:LIMit<1>:BURSt:ALL:RESult?	124
CALCulate<n>:LIMit<1>:BURSt:EVM[:AVERage]	124
CALCulate<n>:LIMit<1>:BURSt:EVM[:AVERage]:RESult?	125
CALCulate<n>:LIMit<1>:BURSt:EVM:ALL[:AVERage]	125
CALCulate<n>:LIMit<1>:BURSt:EVM:ALL[:AVERage]:RESult?	126
CALCulate<n>:LIMit<1>:BURSt:EVM:ALL:MAXimum	126
CALCulate<n>:LIMit<1>:BURSt:EVM:ALL:MAXimum:RESult?	126
CALCulate<n>:LIMit<1>:BURSt:EVM:DATA[:AVERage]	127
CALCulate<n>:LIMit<1>:BURSt:EVM:DATA[:AVERage]:RESult?	127
CALCulate<n>:LIMit<1>:BURSt:EVM:DATA:MAXimum	128
CALCulate<n>:LIMit<1>:BURSt:EVM:DATA:MAXimum:RESult?	128
CALCulate<n>:LIMit<1>:BURSt:EVM:MAXimum	128
CALCulate<n>:LIMit<1>:BURSt:EVM:MAXimum:RESult?	129
CALCulate<n>:LIMit<1>:BURSt:EVM:PILOt[:AVERage]	129
CALCulate<n>:LIMit<1>:BURSt:EVM:PILOt[:AVERage]:RESult?	129
CALCulate<n>:LIMit<1>:BURSt:EVM:PILOt:MAXimum	130
CALCulate<n>:LIMit<1>:BURSt:EVM:PILOt:MAXimum:RESult?	130
CALCulate<n>:LIMit<1>:BURSt:FERRor[:AVERage]	131
CALCulate<n>:LIMit<1>:BURSt:FERRor[:AVERage]:RESult?	131
CALCulate<n>:LIMit<1>:BURSt:FERRor:MAXimum	131
CALCulate<n>:LIMit<1>:BURSt:FERRor:MAXimum:RESult?	131
CALCulate<n>:LIMit<1>:BURSt:IQOFset[:AVERage]	132
CALCulate<n>:LIMit<1>:BURSt:IQOFset[:AVERage]:RESult?	132
CALCulate<n>:LIMit<1>:BURSt:IQOFset:MAXimum	132
CALCulate<n>:LIMit<1>:BURSt:IQOFset:MAXimum:RESult?	133
CALCulate<n>:LIMit<1>:BURSt:SYMBOLerror[:AVERage]	133
CALCulate<n>:LIMit<1>:BURSt:SYMBOLerror[:AVERage]:RESult?	133
CALCulate<n>:LIMit<1>:BURSt:SYMBOLerror:MAXimum	133
CALCulate<n>:LIMit<1>:BURSt:SYMBOLerror:MAXimum:RESult?	134
CALCulate<n>:LIMit<1>:BURSt:TFALI[:AVERage]	134
CALCulate<n>:LIMit<1>:BURSt:TFALI[:AVERage]:RESult?	134
CALCulate<n>:LIMit<1>:BURSt:TFALI:MAXimum	134
CALCulate<n>:LIMit<1>:BURSt:TFALI:MAXimum:RESult?	135
CALCulate<n>:LIMit<1>:BURSt:TRISe[:AVERage]	135
CALCulate<n>:LIMit<1>:BURSt:TRISe[:AVERage]:RESult?	135
CALCulate<n>:LIMit<1>:BURSt:TRISe:MAXimum	136
CALCulate<n>:LIMit<1>:BURSt:TRISe:MAXimum:RESult?	136
CALCulate<n>:LIMit<1>:CONTrol[:DATA]	136
CALCulate<n>:LIMit<k>:FAIL?	137

CALCulate<n>:LIMit<1>:SPECtrum:MASK:CHECK:X?	137
CALCulate<n>:LIMit<1>:SPECtrum:MASK:CHECK:Y?	138
CALCulate<n>:LIMit<1>:UPPer[:DATA]	138

CALCulate<n>:LIMit<1>:ACPpower:ACHannel?

This command returns the ACP adjacent channel limit for IEEE 802.11j if defined.

Suffix:

<n> 1...4
 irrelevant

Return values:

<Result> numeric value in dB

Example:

`CALC:LIM:ACP:ACH?`

Returns the IEEE 802.11j ACP adjacent channel limit.

Usage: Query only

Mode: WLAN

CALCulate<n>:LIMit<k>:ACPpower:ACHannel:RESult

This command queries the result of the limit check for the upper/lower adjacent channel when adjacent channel power measurement is performed.

If the power measurement of the adjacent channel is switched off, the command produces a query error.

Suffix:

<n> Selects the measurement window.
<k> irrelevant

Return values:

Result The result is returned in the form <result>, <result> where <result> = PASSED | FAILED, and where the first returned value denotes the lower, the second denotes the upper adjacent channel.

Example:

```
CALC:LIM:ACP:ACH 30DB, 30DB
```

Sets the relative limit value for the power in the lower and upper adjacent channel to 30 dB below the power in the channel.

```
CALC:LIM:ACP:ACH:ABS -35DBM, -35DBM
```

Sets the absolute limit value for the power in the lower and upper adjacent channel to -35 dB.

```
CALC:LIM:ACP ON
```

Switches on globally the limit check for the channel/adjacent channel measurement.

```
CALC:LIM:ACP:ACH:STAT ON
```

Switches on the limit check for the adjacent channels.

```
INIT;*WAI
```

Starts a new measurement and waits for the sweep end.

```
CALC:LIM:ACP:ACH:RES?
```

Queries the limit check result in the adjacent channels.

CALCulate<n>:LIMit<1>:ACPpower:ALternate?

This command returns the ACP alternate channel limit for IEEE 802.11j if defined.

Suffix:

<n> 1...4
irrelevant

Return values:

<Result> numeric value in dB

Example:

```
CALC:LIM:ACP:ALT?
```

Returns the IEEE 802.11j ACP alternate channel limit.

Usage:

Query only

Mode:

WLAN

CALCulate<n>:LIMit<k>:ACPpower:ALternate<channel>[:RELative] <LowerLimit>, <UpperLimit>

This command defines the limit for the alternate adjacent channels for adjacent channel power measurements. The reference value for the relative limit value is the measured channel power.

Suffix:

<n> Selects the measurement window.

<k> irrelevant

<Channel> 1...11
the alternate channel

Parameters:

<LowerLimit>, first value: 0 to 100dB; limit for the lower and the upper alternate adjacent channel
<UpperLimit>

*RST: 0 DB

Example: `CALC:LIM:ACP:ALT2 30DB, 30DB`
Sets the relative limit value for the power in the lower and upper second alternate adjacent channel to 30 dB below the channel power.

CALCulate<n>:LIMit<1>:BURSt:ALL

This command sets or returns all the limit values.

Suffix:

<n> 1...4
 irrelevant

Return values:

<Results> The results are input or output as a list of values separated by ',' in the following (ASCII) format:
 <average frequency error>, <max frequency error>,
 <average symbol error>, <max symbol error>,
 <average IQ offset>, <maximum IQ offset>,
 <average EVM all bursts>, <max EVM all bursts>,
 <average EVM data carriers >, <max EVM data carriers >
 <average EVM pilots >, <max EVM pilots >
 The units for the EVM results are specified with the `UNIT:EVM` command.

Example: `CALC:LIM:BURS:ALL?`
All limit values are returned

Mode: WLAN

CALCulate<n>:LIMit<1>:BURSt:ALL:RESUlt?

This command returns all the limit results.

Suffix:

<n> 1...4
 irrelevant

Return values:

<Results> For details on formats refer to [FETCh:BURSt:ALL?](#) on page 170.

Example: `CALC:LIM:BURS:ALL:RES?`
All limit values are returned

Usage: Query only

Mode: WLAN

CALCulate<n>:LIMit<1>:BURSt:EVM[:AVERAge] <Value>

This command sets the average error vector magnitude limit for the IEEE 802.11b standard.

Suffix:	
<n>	1...4 irrelevant
Parameters:	
<Value>	numeric value in dB
Example:	CALC:LIM:BURS:EVM -25.0 Average EVM limit is set to -25 dB
Mode:	WLAN

CALCulate<n>:LIMit<1>:BURSt:EVM[:AVERAge]:RESult?

This command returns the average error vector magnitude limit result for the IEEE 802.11b standard.

Suffix:	
<n>	1...4 irrelevant
Return values:	
<Results>	0 1 0 PASSED 1 FAILED
Example:	CALC:LIM:BURS:EVM:RES? Average EVM limit result is returned
Usage:	Query only
Mode:	WLAN

CALCulate<n>:LIMit<1>:BURSt:EVM:ALL[:AVERAge] <Value>

This command sets the average error vector magnitude limit. This is a combined figure that represents the pilot, data and the free carrier.

Suffix:	
<n>	1...4 irrelevant
Parameters:	
<Value>	numeric value in dB
Example:	CALC:LIM:BURS:EVM:ALL -25.0 Average EVM for all carrier limit is set to -25.0 dB
Mode:	WLAN

CALCulate<n>:LIMit<1>:BURSt:EVM:ALL[:AVERAge]:RESult?

This command returns the average error vector magnitude limit result. This is a combined figure that represents the pilot, data and the free carrier.

Suffix:

<n> 1...4
irrelevant

Return values:

<Results> 0 | 1
0
PASSED
1
FAILED

Example:

CALC:LIM:BURS:EVM:ALL:RES?
Average EVM for all carrier limit result is returned

Usage:

Query only

Mode:

WLAN

CALCulate<n>:LIMit<1>:BURSt:EVM:ALL:MAXimum <Value>

This command sets the maximum error vector magnitude limit. This is a combined figure that represents the pilot, data and the free carrier.

Suffix:

<n> 1...4
irrelevant

Parameters:

<Value> numeric value in dB

Example:

CALC:LIM:BURS:EVM:ALL:MAX?
Maximum EVM for all carrier limit is returned

Mode:

WLAN

CALCulate<n>:LIMit<1>:BURSt:EVM:ALL:MAXimum:RESult?

This command returns the maximum error vector magnitude limit result. This is a combined figure that represents the pilot, data and the free carrier.

Suffix:

<n> 1...4
irrelevant

Return values:

<Results> 0 | 1
0
 PASSED
1
 FAILED

Example:

CALC:LIM:BURS:EVM:ALL:MAX:RES?
 Maximum EVM for all carrier limit result is returned

Usage:

Query only

Mode:

WLAN

CALCulate<n>:LIMit<1>:BURSt:EVM:DATA[:AVERAge] <Value>

This command sets the average error vector magnitude limit summary for the data carrier.

Suffix:

<n> 1...4
 irrelevant

Parameters:

<Value> numeric value in dB

Example:

CALC:LIM:BURS:EVM:DATA -30.0
 Average EVM for data carrier limit is set to -30.0 dB

Mode:

WLAN

CALCulate<n>:LIMit<1>:BURSt:EVM:DATA[:AVERAge]:RESult?

This command returns the average error vector magnitude limit result summary for the data carrier.

Suffix:

<n> 1...4
 irrelevant

Return values:

Results 0 | 1
0
 PASSED
1
 FAILED

Example:

CALC:LIM:BURS:EVM:DATA:RES?
 Average EVM for data carrier limit result is returned

Usage:

Query only

Mode:

WLAN

CALCulate<n>:LIMit<1>:BURSt:EVM:DATA:MAXimum <Value>

This command sets the maximum error vector magnitude limit summary for the data carrier.

Suffix:

<n> 1...4
irrelevant

Parameters:

<Value> numeric value in dB

Example:

CALC:LIM:BURS:EVM:DATA:MAX?
Maximum EVM for data burst limit is returned

Mode: WLAN

CALCulate<n>:LIMit<1>:BURSt:EVM:DATA:MAXimum:RESult?

This command returns the maximum error vector magnitude limit result summary for the data carrier.

Suffix:

<n> 1...4
irrelevant

Return values:

<Results> 0 | 1
0
PASSED
1
FAILED

Example:

CALC:LIM:BURS:EVM:DATA:MAX:RES?
Maximum EVM for data carrier limit result is returned Characteristics.

Usage: Query only

Mode: WLAN

CALCulate<n>:LIMit<1>:BURSt:EVM:MAXimum <Value>

This command sets the maximum error vector magnitude limit for the IEEE 802.11b standard.

Suffix:

<n> 1...4
irrelevant

Parameters:

<Value> numeric value in dB

Example: `CALC:LIM:BURS:EVM:MAX?`
Maximum EVM limit is returned

Mode: WLAN

CALCulate<n>:LIMit<1>:BURSt:EVM:MAXimum:RESult?

This command returns the maximum error vector magnitude limit result for the IEEE 802.11b standard.

Suffix:
<n> 1...4
irrelevant

Return values:
<Results> 0 | 1
0
PASSED
1
FAILED

Example: `CALC:LIM:BURS:EVM:MAX:RES?`
Maximum EVM limit result is returned

Usage: Query only

Mode: WLAN

CALCulate<n>:LIMit<1>:BURSt:EVM:PILot[:AVERage] <Value>

This command sets the average error vector magnitude limit summary for the pilot carriers.

Suffix:
<n> 1...4
irrelevant

Parameters:
<Value> numeric value in dB

Example: `CALC:LIM:BURS:EVM:PIL -8.0`
Average EVM for pilot carrier limit is set to -8.0 dB

Mode: WLAN

CALCulate<n>:LIMit<1>:BURSt:EVM:PILot[:AVERage]:RESult?

This command returns the average error vector magnitude limit result summary for the pilot carriers.

Suffix:
<n> 1...4
irrelevant

Return values:

<Results> 0 | 1
0
 PASSED
1
 FAILED

Example:

CALC:LIM:BURS:EVM:PIL:RES?
 Average EVM for pilot carrier limit result is returned

Usage:

Query only

Mode:

WLAN

CALCulate<n>:LIMit<1>:BURSt:EVM:PILot:MAXimum <Value>

This command sets the maximum error vector magnitude limit summary for the pilot carriers.

Suffix:

<n> 1...4
 irrelevant

Parameters:

<Value> numeric value in dB

Example:

CALC:LIM:BURS:EVM:PIL:MAX?
 Maximum EVM for pilot carrier limit is returned

Mode:

WLAN

CALCulate<n>:LIMit<1>:BURSt:EVM:PILot:MAXimum:RESult?

This command returns the maximum error vector magnitude limit result summary for the pilot carriers.

Suffix:

<n> 1...4
 irrelevant

Return values:

<Results> 0 | 1
0
 PASSED
1
 FAILED

Example:

CALC:LIM:BURS:EVM:PIL:MAX:RES?
 Maximum EVM for pilot carrier limit result is returned

Usage:

Query only

Mode:

WLAN

CALCulate<n>:LIMit<1>:BURSt:FERRor[:AVERAge] <Value>

This command sets the average frequency error limit.

Suffix:

<n> 1...4
 irrelevant

Parameters:

<Value> numeric value in Hertz

Example:

CALC:LIM:BURS:FERR 10000

The average frequency error limit is set to 10 kHz

Mode:

WLAN

CALCulate<n>:LIMit<1>:BURSt:FERRor[:AVERAge]:RESult?

This command returns the average frequency error limit result.

Suffix:

<n> 1...4
 irrelevant

Example:

CALC:LIM:BURS:FERR:RES?

Average frequency error limit result is returned

Usage:

Query only

Mode:

WLAN

CALCulate<n>:LIMit<1>:BURSt:FERRor:MAXimum <Value>

This command sets the maximum frequency error limit.

Suffix:

<n> 1...4
 irrelevant

Parameters:

<Value> numeric value in Hertz

Example:

CALC:LIM:BURS:FERR:MAX?

Maximum frequency error limit is returned

Mode:

WLAN

CALCulate<n>:LIMit<1>:BURSt:FERRor:MAXimum:RESult?

This command returns the maximum frequency error limit result.

Suffix:

<n> 1...4
 irrelevant

Example: `CALC:LIM:BURS:FERR:MAX:RES?`
Maximum frequency error limit result is returned

Usage: Query only

Mode: WLAN

CALCulate<n>:LIMit<1>:BURSt:IQOFset[:AVERAge] <Value>

This command sets the average IQ Offset error limit.

Suffix:
<n> 1...4
irrelevant

Parameters:
<Value> Range: -1000000 to 1000000
Default unit: dB

Example: `CALC:LIM:BURS:IQOF -10.0`
Average IQ Off set error limit is set to -10.0 dB

Mode: WLAN

CALCulate<n>:LIMit<1>:BURSt:IQOFset[:AVERAge]:RESult?

This command returns the average IQ Offset error limit result.

Suffix:
<n> 1...4
irrelevant

Example: `CALC:LIM:BURS:IQOF:RES?`
Average IQ Offset error limit result is returned

Usage: Query only

Mode: WLAN

CALCulate<n>:LIMit<1>:BURSt:IQOFset:MAXimum <Value>

This command sets the maximum IQ Offset error limit.

Suffix:
<n> 1...4
irrelevant

Parameters:
<Value> Range: -1000000 to 1000000
Default unit: dB

Example: `CALC:LIM:BURS:IQOF:MAX 15.0`
Maximum IQ Off set error limit is set to -15.0 dB

Mode: WLAN

CALCulate<n>:LIMit<1>:BURSt:IQOFset:MAXimum:RESult?

This command returns the maximum IQ Offset error limit result.

Suffix:

<n> 1...4
irrelevant

Example:

CALC:LIM:BURS:IQOF:MAX:RES?
Maximum IQ Offset error limit result is returned

Usage:

Query only

Mode:

WLAN

CALCulate<n>:LIMit<1>:BURSt:SYMBOLerror[:AVERage] <Value>

This command sets the average symbol error limit.

Suffix:

<n> 1...4
irrelevant

Parameters:

<Value> numeric value in Hertz

Example:

CALC:LIM:BURS:SYMB 10000
The average symbol error limit is set to 10kHz

Mode:

WLAN

CALCulate<n>:LIMit<1>:BURSt:SYMBOLerror[:AVERage]:RESult?

This command returns the average symbol error limit result.

Suffix:

<n> 1...4
irrelevant

Example:

CALC:LIM:BURS:SYMB:RES?
Average symbol error limit result is returned

Usage:

Query only

Mode:

WLAN

CALCulate<n>:LIMit<1>:BURSt:SYMBOLerror:MAXimum <Value>

This command sets the maximum symbol error limit.

Suffix:

<n> 1...4
irrelevant

Parameters:

<Value> numeric value in Hertz

Example: `CALC:LIM:BURS:SYMB:MAX?`
Maximum symbol error limit is returned

Mode: WLAN

CALCulate<n>:LIMit<1>:BURSt:SYMBolerror:MAXimum:RESult?

This command returns the maximum symbol error limit result.

Suffix:
<n> 1...4
 irrelevant

Example: `CALC:LIM:BURS:SYMB:MAX:RES?`
Maximum symbol error limit result is returned.

Usage: Query only

Mode: WLAN

CALCulate<n>:LIMit<1>:BURSt:TFALI[:AVERAge] <Value>

This command sets the average fall time limit.

Suffix:
<n> 1...4
 irrelevant

Parameters:
<Value> numeric value in seconds

Example: `CALC:LIM:BURS:TFAL 0.000001`
The average fall time limit is set to 1 μ s

Mode: WLAN

CALCulate<n>:LIMit<1>:BURSt:TFALI[:AVERAge]:RESult?

This command returns the average fall time limit result.

Suffix:
<n> 1...4
 irrelevant

Example: `CALC:LIM:BURS:TFAL1:RES?`
Average fall time limit result is returned

Usage: Query only

Mode: WLAN

CALCulate<n>:LIMit<1>:BURSt:TFALI:MAXimum <Value>

This command sets the maximum fall time limit.

Suffix:
 <n> 1...4
 irrelevant

Parameters:
 <Value> numeric value in seconds

Example: CALC:LIM:BURS:TFALL:MAX 0.000001
 The maximum fall time limit set to 1 μ s.

Mode: WLAN

CALCulate<n>:LIMit<1>:BURSt:TFALI:MAXimum:RESult?

This command returns the maximum fall time limit result.

Suffix:
 <n> 1...4
 irrelevant

Example: CALC:LIM:BURS:TRIS:MAX:RES?
 Maximum fall time limit result is returned

Usage: Query only

Mode: WLAN

CALCulate<n>:LIMit<1>:BURSt:TRISe[:AVERAge] <Value>

This command sets the average rise time limit.

Suffix:
 <n> 1...4
 irrelevant

Parameters:
 <Value> numeric value in seconds

Example: CALC:LIM:BURS:TRIS 0.000001
 The average rise time limit is set to 1 μ s

Mode: WLAN

CALCulate<n>:LIMit<1>:BURSt:TRISe[:AVERAge]:RESult?

This command returns the average rise time limit result.

Suffix:
 <n> 1...4
 irrelevant

Example: CALC:LIM:BURS:TRIS:RES?
 The average rise time limit result is returned

Usage: Query only

Mode: WLAN

CALCulate<n>:LIMit<1>:BURSt:TRISe:MAXimum <Value>

This command sets the maximum rise time limit.

Suffix:

<n> 1...4
irrelevant

Parameters:

<Value> numeric value in seconds

Example: CALC:LIM:BURS:TRIS:MAX 0.000001
Maximum rise time limit is set to 1 ∞s

Mode: WLAN

CALCulate<n>:LIMit<1>:BURSt:TRISe:MAXimum:RESult?

This command returns the maximum rise time limit result.

Suffix:

<n> 1...4
irrelevant

Example: CALC:LIM:BURS:TRIS:MAX:RES?
Maximum rise time limit result is returned

Usage: Query only

Mode: WLAN

CALCulate<n>:LIMit<1>:CONTrol[:DATA] <Value>

This command defines the X-axis values (frequencies) of the upper or lower limit lines. The number of values for the CONTrol axis and for the corresponding UPPer limit line has to be identical. Otherwise default values are entered for missing values or unnecessary values are deleted.

Parameters:

<Value>

Example: CALC:LIM2:CONT 1MHz,30MHz,100MHz, 300MHz,1GHz
Defines 5 reference values for the X-axis of limit line 2
CALC:LIM2:CONT?
Outputs the reference values for the X-axis of limit line 2 separated by a comma.

Mode: WLAN

CALCulate<n>:LIMit<k>:FAIL?

This command queries the result of a limit check.

Note that for SEM measurements, the limit line suffix <k> is irrelevant, as only one specific SEM limit line is checked for the currently relevant power class.

To get a valid result, you have to perform a complete measurement with synchronization to the end of the measurement before reading out the result. This is only possible for single sweeps.

Suffix:

<n> irrelevant
 <k> limit line
 For option WLAN TX Measurements, R&S FSV-K91/91n, see table below

Return values:

<Result> **0**
 PASS
 1
 FAIL

Example:

```
INIT; *WAI
Starts a new sweep and waits for its end.
CALC:LIM3:FAIL?
Queries the result of the check for limit line 3.
```

Usage: Query only

For option WLAN TX Measurements, R&S FSV-K91/91n, the numeric suffix <k> specifies the limit lines as follows:

Suffix	Limit
1 to 2	These indexes are not used
3	ETSI Spectrum Mask limit line
4	Spectrum Flatness (Upper) limit line
5	Spectrum Flatness (Lower) limit line
6	IEEE Spectrum Mask limit line
7	PVT Rising Edge max limit
8	PVT Rising Edge mean limit
9	PVT Falling Edge max limit
10	PVT Falling Edge mean limit

CALCulate<n>:LIMit<1>:SPECtrum:MASK:CHECK:X?

This command returns the X-value at the maximum overstepping of the spectrum mask limits.

Suffix:	
<n>	1...4 irrelevant
Example:	CALC:LIM:SPEC:MASK:CHEC:X? Returns the frequency at the maximum overstepping.
Usage:	Query only
Mode:	WLAN

CALCulate<n>:LIMit<1>:SPECtrum:MASK:CHECK:Y?

This command returns the Y-value at the maximum overstepping of the spectrum mask limits.

Suffix:	
<n>	1...4 irrelevant
Example:	CALC:LIM:SPEC:MASK:CHEC:Y? Returns the power at the maximum overstepping.
Usage:	Query only
Mode:	WLAN

CALCulate<n>:LIMit<1>:UPPer[:DATA] <Value>

This command defines the values for the upper limit lines independently of the measurement window. The number of values for the CONTROL axis and for the corresponding UPPER limit line has to be identical. Otherwise default values are entered for missing values or unnecessary values are deleted.

Suffix:	
<n>	1...4 irrelevant
Parameters:	
<Value>	
Example:	CALC:LIM2:UPP -10,0,0,-10,-5 Defines 5 upper limit values for limit line 2 in the preset unit. CALC:LIM2:UPP? Outputs the upper limit values for limit line 2 separated by a comma.
Mode:	WLAN

5.5 CALCulate:MARKer Subsystem (WLAN)

The CALCulate:MARKer subsystem checks the marker functions of the instrument.

The following subsystem is included:

[chapter 5.5.2, "CALCulate:MARKer:FUNCTION Subsystem \(WLAN, R&S FSV-K91/91n\)", on page 144](#)

5.5.1 Description of the CALCulate:MARKer Subsystem (WLAN, R&S FSV K91/91n)..... 139
 5.5.2 CALCulate:MARKer:FUNCTION Subsystem (WLAN, R&S FSV-K91/91n)..... 144

5.5.1 Description of the CALCulate:MARKer Subsystem (WLAN, R&S FSV K91/91n)

CALCulate<n>:MARKer<m>[:STATe]..... 139
 CALCulate<n>:MARKer<m>:AOFF..... 139
 CALCulate<n>:MARKer<1>:BSYMBOL..... 140
 CALCulate<n>:MARKer<1>:CARRIER..... 140
 CALCulate<n>:MARKer<1>:MAXimum..... 141
 CALCulate<n>:MARKer<1>:MINimum..... 141
 CALCulate<n>:MARKer<1>:SYMBOL..... 141
 CALCulate<n>:MARKer<1>:TRACE..... 142
 CALCulate<n>:MARKer<1>:X..... 142
 CALCulate<n>:MARKer<1>:Y..... 143

CALCulate<n>:MARKer<m>[:STATe] <State>

This command turns markers on and off.

If the corresponding marker number is currently active as a deltamarker, it is turned into a normal marker.

Suffix:

- <n> Selects the measurement window.
- <m> depends on mode
 Selects the marker.

Parameters:

- <State> ON | OFF
- *RST: OFF

Example:

CALC:MARK3 ON
 Switches on marker 3 or switches to marker mode.

Manual operation: See "[Marker 1](#)" on page 112

CALCulate<n>:MARKer<m>:AOFF

This command all markers off, including delta markers and marker measurement functions.

Suffix:

- <n> Selects the measurement window.

<m> depends on mode
irrelevant

Example: CALC:MARK:AOFF
Switches off all markers.

Usage: Event

Manual operation: See "[Marker Off](#)" on page 112

CALCulate<n>:MARKer<1>:BSYMBOL <BurstNumber>, <SymbolNumber>

This command positions the selected marker to the indicated symbol in the indicated burst.

This command only applies to 802.11b standard for the following result displays:

- Constellation vs Symbol
- EVM vs Symbol

Suffix:

<n> 1...4
irrelevant

Parameters:

<BurstNumber>, The first numeric value is the burst number and the second
<SymbolNumber> numeric value is the symbol number.

Example: CALC:MARK1:BSYM 2,10
Positions marker 1 to symbol 10 of burst 2.
CALC:MARK1:BSYM?
Outputs the burst and symbol values of marker 1.

Mode: WLAN

CALCulate<n>:MARKer<1>:CARRIER <Carrier>

This command positions the selected marker to the indicated carrier.

This command is query only for the following result displays:

- Constellation vs Symbol
- Constellation vs Carrier

Suffix:

<n> 1...4
irrelevant

Parameters:

<Carrier>

Example: CALC:MARK:CARR -7
Positions marker 1 to carrier -7.
CALC:MARK:CARR?
Outputs the carrier value of marker 1.

Mode: WLAN, OFDM, OFDMA/WiBro

Manual operation: See "[Marker 1](#)" on page 112

CALCulate<n>:MARKer<1>:MAXimum

This command sets the selected marker to the maximum peak value in the current trace. This command is only available for the Spectrum Flatness result display.

Suffix:

<n> 1...4
window

Example: CALC2:MARK:MAX
Set marker 1 in screen B to maximum value in trace.

Mode: WLAN, OFDM, OFDMA/WiBro

Manual operation: See "[Peak \(Spectrum Flatness result display\)](#)" on page 112

CALCulate<n>:MARKer<1>:MINimum

This command sets the selected marker to the minimum peak value in the current trace. This command is only available for the Spectrum Flatness result display.

Suffix:

<n> 1...4
window

Example: CALC2:MARK:MIN
Set marker 1 in screen B to minimum value in trace.

Mode: WLAN, OFDM, OFDMA/WiBro

Manual operation: See "[Min \(Spectrum Flatness result display\)](#)" on page 112

CALCulate<n>:MARKer<1>:SYMBOL <Symbol>

This command positions the selected marker to the indicated symbol.

This command is query only for the following result displays:

- Constellation vs Symbol
- Constellation vs Carrier

Suffix:

<n> 1...4
window

Parameters:

<Symbol> 1 to <number of symbols in selected burst>

Example: `CALC2:MARK:SYMB 2`
 Positions marker 1 in screen B to symbol 2.
 `CALC2:MARK:SYMB?`
 Outputs the symbol value of marker 1 in screen B.

Mode: WLAN, OFDM, OFDMA/WiBro

Manual operation: See "[Marker 1](#)" on page 112

CALCulate<n>:MARKer<1>:TRACe <TraceNo>

This command assigns the selected marker to the indicated measurement curve in the selected measurement window.

This command is only available for the following result displays:

- Constellation versus Carrier
- EVM vs Symbol
- Frequency Error vs Preamble
- Phase Error vs Preamble
- PVT Full Burst
- PVT Rising/Falling
- Spectrum Flatness
- Spectrum Mask, if Max Hold trace is displayed
- Spectrum ACP/ACPR, if Max Hold trace is displayed

Suffix:

<n> 1...4
 window

Parameters:

<TraceNo> Trace number to be assigned to the marker.
 *RST: 1

Example: `"CALC2:MARK:TRAC 2`
 Assigns marker 1 in screen B to trace 2.

Mode: WLAN

Manual operation: See "[MKR -> Trace](#)" on page 113

CALCulate<n>:MARKer<1>:X <Position>

This command positions the selected marker to the indicated inphase (Constellation vs Symbol), frequency (Spectrum FFT, Spectrum Mask, Spectrum APCR), time (Magnitude Capture Buffer, Auto level, PVT Full Burst, PVT Rising / Falling), power (CCDF), sub-carrier (Constellation vs Carrier, EVM vs Carrier, Spectrum Flatness) or symbol (EVM vs Symbol) in the selected measurement window.

This command is query only for the following result displays:

- Constellation vs Symbol

- Constellation vs Carrier

Suffix:

<n> 1...4
window

Parameters:

<Position> 1 to <maximum range for selected measurement>

Example:

CALC:MARK:X 2ms
Positions marker 1 in screen A to time 2ms.

Mode:

WLAN, OFDMA/WiBro

Manual operation: See "[Marker 1](#)" on page 112

CALCulate<n>:MARKer<1>:Y <Position>

This command positions the selected marker to the indicated quadrature (Constellation vs Symbol), magnitude of I or Q (Constellation vs Carrier), EVM (EVM vs Carrier) or abs (Spectrum Flatness) in the selected measurement window.

This command is query only for the following result displays:

- Auto Level
- Constellation vs Symbol
- Constellation vs Carrier
- EVM vs Symbol
- PVT Full
- PVT Rising/Falling
- Magnitude Capture Buffer
- Spectrum Mask
- Spectrum ACP/ACPR
- Spectrum FFT
- CCDF

Suffix:

<n> 1...4
window

Parameters:

<Position>

Example:

CALC2:MARK:Y -2
Positions marker 1 in screen B to -2.
CALC:MARK:Y?
Outputs the measured value of marker 1.

Mode:

WLAN; OFDMA/WiBro

Manual operation: See "[Marker 1](#)" on page 112

5.5.2 CALCulate:MARKer:FUNCTION Subsystem (WLAN, R&S FSV-K91/91n)

The measurement window is selected by CALCulate 1 (screen A) or 2 (screen B).

CALCulate<n>:MARKer<1>:FUNCTION:POWER:RESult[:CURRent]?.....	144
CALCulate<n>:MARKer<1>:FUNCTION:POWER:RESult:MAXHold?.....	144
CALCulate<n>:MARKer<1>:FUNCTION:ZOOM.....	145

CALCulate<n>:MARKer<1>:FUNCTION:POWER:RESult[:CURRent]?

This command queries the current result values of the adjacent channel power measurement. An ACPR (Adjacent channel power relative) measurement must have previously been run, for there to be summary data available.

Results are output separated by commas in the following order:

- Power of main channel
- Power of lower adjacent channel
- Power of upper adjacent channel
- Power of lower alternate adjacent channel 1
- Power of upper alternate adjacent channel 1
- Power of lower alternate adjacent channel 2
- Power of upper alternate adjacent channel 2

Adjacent channel power values are output in dB.

Suffix:

<n> 1...4
 irrelevant

Example: CALC:MARK:FUNC:POW:RES?

Usage: Query only

Mode: WLAN

Manual operation: See "Spectrum ACPR (IEEE 802.11a, ac, g (OFDM Turbo Mode), n, p)/ Spectrum ACP (IEEE 802.11b)/ ACP Rel/Abs (IEEE 802.11j)" on page 80

CALCulate<n>:MARKer<1>:FUNCTION:POWER:RESult:MAXHold?

This command queries the maximum result values of the adjacent channel power measurement. An ACPR (Adjacent channel power relative) measurement must have previously been run with more than one sweep, for there to be maximum summary data available.

For details on the output refer to [CALCulate<n>:MARKer<1>:FUNCTION:POWER:RESult\[:CURRent\]?](#) on page 144 .

Suffix:	
<n>	1...4 irrelevant
Example:	CALC:MARK:FUNC:POW:RES:MAXH?
Usage:	Query only
Mode:	WLAN
Manual operation:	See "Spectrum ACPR (IEEE 802.11a, ac, g (OFDM Turbo Mode), n, p)/ Spectrum ACP (IEEE 802.11b)/ ACP Rel/Abs (IEEE 802.11j)" on page 80

CALCulate<n>:MARKer<1>:FUNction:ZOOM <Factor>

This command sets the magnification factor for the zoom. It is only available for the following result displays:

- Constellation vs Carrier
- Constellation vs Symbol
- PVT
- Magnitude Capture Buffer

Suffix:	
<n>	1...4 irrelevant

Parameters:
<Factor>

Example: INIT:CONT OFF
Switches to single sweep mode
CALC:MARK:FUNC:ZOOM 3;*WAI
Activates zooming and waits for its end.

Mode: WLAN

Manual operation: See "Unzoom" on page 112
See "Marker Zoom" on page 112

5.6 CONFigure Subsystem (WLAN)

The CONFigure subsystem contains commands for configuring complex measurement tasks. The CONFigure subsystem is closely linked to the functions of the FETCH subsystem, where the measurement results are queried.

CONFigure:BURSt:CONStellation:CARRier:SElect.....	146
CONFigure:BURSt:CONStellation:CCARRier[:IMMEDIATE].....	147
CONFigure:BURSt:CONStellation:CSYMBOL[:IMMEDIATE].....	147
CONFigure:BURSt:EVM:ECARRier[:IMMEDIATE].....	147
CONFigure:BURSt:EVM:ESYMBOL[:IMMEDIATE].....	148

CONFigure:BURSt:PREamble[:IMMediate]	148
CONFigure:BURSt:PREamble:SElect	148
CONFigure:BURSt:PVT[:IMMediate]	148
CONFigure:BURSt:PVT:AVERage	149
CONFigure:BURSt:PVT:RPOWer	149
CONFigure:BURSt:PVT:SElect	149
CONFigure:BURSt:SPECtrum:ACPR[:IMMediate]	150
CONFigure:BURSt:SPECtrum:FFT[:IMMediate]	150
CONFigure:BURSt:SPECtrum:FLATness[:IMMediate]	151
CONFigure:BURSt:SPECtrum:FLATness:CSElect	151
CONFigure:BURSt:SPECtrum:FLATness:SElect	151
CONFigure:BURSt:SPECtrum:MASK[:IMMediate]	152
CONFigure:BURSt:SPECtrum:MASK:SElect	152
CONFigure:BURSt:STATistics:BSTReam[:IMMediate]	152
CONFigure:BURSt:STATistics:CCDF[:IMMediate]	152
CONFigure:BURSt:STATistics:SFIeld[:IMMediate]	153
CONFigure:CHANnel	153
CONFigure:POWer:AUTO	153
CONFigure:POWer:AUTO:SWEep:TIME	154
CONFigure:POWer:EXPEcted:RF	154
CONFigure:POWer:EXPEcted:IQ	154
CONFigure:STANdard	154
CONFigure:WLAN:ANTMatrix:ADDRes<RecPath>	155
CONFigure:WLAN:ANTMatrix:ANTenna<RecPath>	155
CONFigure:WLAN:ANTMatrix:STATe<RecPath>	156
CONFigure:WLAN:DUTConfig	156
CONFigure:WLAN:EXTension:AUTO:TYPE	156
CONFigure:WLAN:GTIme:AUTO	157
CONFigure:WLAN:GTIme:AUTO:TYPE	157
CONFigure:WLAN:GTIme:SElect	158
CONFigure:WLAN:MIMo:CAPTure	159
CONFigure:WLAN:MIMo[:CAPTure]:TYPE	159
CONFigure:WLAN:OSP:ADDRes	160
CONFigure:WLAN:OSP:MODule	160
CONFigure:WLAN:PAYload:LENGth:SRC	160
CONFigure:WLAN:PVERror:MRANge	161
CONFigure:WLAN:RSYNc:JOINed	161
CONFigure:WLAN:SMAPping:MODE	161
CONFigure:WLAN:SMAPping:NORMalise	162
CONFigure:WLAN:SMAPping:TX<1...4>	162
CONFigure:WLAN:SMAPping:TX<1...4>:STReam<1...4>	162
CONFigure:WLAN:SMAPping:TX<1...4>:TIMeshift	163
CONFigure:WLAN:STBC:AUTO:TYPE	163

CONFigure:BURSt:CONStellation:CARRier:SElect <Mode>

This remote control command is only available when Constellation vs Symbol measurement is selected. When the Constellation versus Symbol measurement is initiated, it will calculate the results of the selected carrier.

Parameters:

<Mode> -26 to 26 | ALL | PILOTS
 *RST: ALL

Example:

CONF:BURS:CONS:CARR:SEL -26
 Carrier -26 is selected.
 CONF:BURS:CONS:CARR:SEL 10
 Carrier 10 is selected.
 CONF:BURS:CONS:CARR:SEL ALL
 All carriers are selected.
 CONF:BURS:CONS:CARR:SEL PIL
 Pilots only.

Mode: WLAN

Manual operation: See "[Carrier Selection \(IEEE 802.11a, ac, g, j, n \(OFDM\), p\)](#)" on page 75

CONFigure:BURSt:CONStellation:CCARrier[:IMMediate]

This remote control command configures the measurement type to be Constellation vs Carrier. After this command has been executed, the specified measurement will only be started when the user issues the `INITiate<n>[:IMMediate]` command.

Example: CONF:BURS:CONS:CCAR
 Configures the Constellation versus Carrier measurement type.

Mode: WLAN

Manual operation: See "[Constell vs Symbol/Carrier](#)" on page 73

CONFigure:BURSt:CONStellation:CSYMBOL[:IMMediate]

This remote control command configures the measurement type to be Constellation vs Symbol. After this command has been executed, the specified measurement will only be started when the user issues the `INITiate<n>[:IMMediate]` command

Example: CONF:BURS:CONS:CSYM
 Configures the Constellation versus Symbol measurement type.

Mode: WLAN

Manual operation: See "[Constell vs Symbol/Carrier](#)" on page 73

CONFigure:BURSt:EVM:ECARrier[:IMMediate]

This remote control command configures the measurement type to be EVM vs Carrier. After this command has been executed, the specified measurement will only be started when the user issues the `INITiate<n>[:IMMediate]` command.

Example: CONF:BURS:EVM:ECAR
 Configures the EVM vs Carrier measurement type.

Mode: WLAN

Manual operation: See ["EVM vs Symbol/Carrier"](#) on page 69

CONFigure:BURSt:EVM:ESYMBOL[:IMMEDIATE]

This remote control command configures the measurement type to be EVM vs Symbol. After this command has been executed, the specified measurement will only be started when the user issues the `INITiate<n>[:IMMEDIATE]` command.

Example: `CONF: BURS: EVM: ESYM`
Configures the EVM vs Symbol measurement type.

Mode: WLAN

Manual operation: See ["EVM vs Symbol/Carrier"](#) on page 69

CONFigure:BURSt:PREamble[:IMMEDIATE]

This remote control command configures the measurement type to be Phase or Frequency vs Preamble. After this command has been executed, the specified measurement will only be started when the user issues the `INITiate<n>[:IMMEDIATE]` command.

Example: `CONF: BURS: PRE`
Configures the preamble measurement type.

Mode: WLAN

Manual operation: See ["Error Frequency/Phase"](#) on page 71

CONFigure:BURSt:PREamble:SElect <Mode>

This remote control command configures the interpretation of the preamble measurement results.

Parameters:
<Mode> PHASe | FREQuency

Example: `CONF: BURS: PRE: SEL PHAS`
Configures the Phase vs Preamble measurement type.

Mode: WLAN

Manual operation: See ["Error Frequency/Phase"](#) on page 71

CONFigure:BURSt:PVT[:IMMEDIATE]

This remote control command configures the measurement type to be Power vs Time. After this command has been executed, the specified measurement will only be started when the user issues the `INITiate<n>[:IMMEDIATE]` command.

Example: `CONF: BURS: PVT`
Configures the Power vs Time measurement type.

Mode: WLAN

Manual operation: See "[PVT](#)" on page 64

CONFigure:BURSt:PVT:AVERAge <Value>

This remote control command configures the measurement type to set the burst power averaging length to the desired value. This command is only valid when the selected standard is IEEE 802.11b.

Parameters:

<Value>

Example: `CONF:BURS:PVT:AVER 31`
Configures the burst power average length of 31.

Mode: WLAN

Manual operation: See "[Average Length \(IEEE 802.11b, g – Single Carrier\)](#)" on page 67

CONFigure:BURSt:PVT:RPOWER <Mode>

This remote control command configures the use of either mean or maximum burst power as a reference power for the 802.11b PVT measurement.

Parameters:

<Mode> MEAN | MAXimum

Example: `CONF:BURS:PVT:RPOW MEAN`
Configures to use mean burst power as a reference power.

Mode: WLAN

Manual operation: See "[Ref Pow Max/Mean \(IEEE 802.11b, g – Single Carrier\)](#)" on page 67

CONFigure:BURSt:PVT:SELEct <Mode>

This remote control configures how to interpret the Power vs Time measurement results.

Parameters:

<Mode>

EDGE

configures the measurement to be rising and falling edge

FALL

configures the measurement to be falling edge only (IEEE 802.11b & g (CCK))

FULL

configures the measurement to be full burst (IEEE 802.11a, j & g (OFDM) n, p, IEEE 802.11 Turbo Mode)

RISE

configures the measurement to be rising edge only (IEEE 802.11b & g (CCK))

Example:

```
CONF: BURS: PVT: SEL FULL
```

Interprets the measurement results as full burst

Mode:

WLAN

Manual operation:

See "Full Burst" on page 65

See "Rising & Falling" on page 65

See "Ramp Up/Down/Up & Down (IEEE 802.11b, g – Single Carrier)" on page 66

CONFigure: BURSt: SPECtrum: ACPR[:IMMediate]

This remote control command configures the measurement type to be ACPR (adjacent channel power relative). After this command has been executed, the specified measurement will only be started when the user issues the `INITiate<n>[:IMMediate]` command.

Example:

```
CONF: BURS: SPEC: ACPR
```

Configures the ACPR measurement type.

Mode:

WLAN

Manual operation:

See "Spectrum ACPR (IEEE 802.11a, ac, g (OFDM Turbo Mode), n, p)/ Spectrum ACP (IEEE 802.11b)/ ACP Rel/Abs (IEEE 802.11j)" on page 80

CONFigure: BURSt: SPECtrum: FFT[:IMMediate]

This remote control command configures the measurement type to be FFT (Fast Fourier Transform). After this command has been executed, the specified measurement will only be started when the user issues the `INITiate<n>[:IMMediate]` command.

Example:

```
CONF: BURS: SPEC: FFT
```

Configures the FFT measurement type.

Mode:

WLAN

Manual operation:

See "Spectrum FFT" on page 79

CONFigure:BURSt:SPECTrum:FLATness[:IMMEDIATE]

This remote control command configures the measurement type to be Spectrum Flatness. After this command has been executed, the specified measurement will only be started when the user issues the `INITiate<n>[:IMMEDIATE]` command.

Example: `CONF: BURS: SPEC: FLAT`
Configures the Spectrum Flatness measurement type.

Mode: WLAN

Manual operation: See "Spectrum Flatness (IEEE 802.11a, ac, g, j, n (OFDM), p / Group Delay (IEEE 802.11 n (MIMO)))" on page 76

CONFigure:BURSt:SPECTrum:FLATness:CSElect <CSelect>

This remote control command configures the Spectrum Flatness channel selection. This command is only valid for IEEE 802.11ac, n and IEEE 802.11n (MIMO).

Parameters:

<CSelect>	EFFECTive Effective channel
	PHYSical Physical channel

Example: `CONF: BURS: SPEC: FLAT: SEL PHY`
Flatness measurement channel is configured as Physical.

Manual operation: See "Chan Sel" on page 82

CONFigure:BURSt:SPECTrum:FLATness:SElect <MeasType>

This remote control command configures the Spectrum Flatness measurement type. This command is only valid for IEEE 802.11ac, n and IEEE 802.11n (MIMO).

Parameters:

<MeasType>	FLATness Spectrum Flatness results
	GRDelay Spectrum Flatness Group Delay results

Example: `CONF: BURS: SPEC: FLAT: SEL GRD`
Flatness measurement type is configured as Spectrum Flatness Group Delay

Manual operation: See "Spectrum Flatness (IEEE 802.11a, ac, g, j, n (OFDM), p / Group Delay (IEEE 802.11 n (MIMO)))" on page 76

CONFigure:BURSt:SPECtrum:MASK[:IMMediate]

This remote control command configures the measurement type to be Spectrum Mask. After this command has been executed, the specified measurement will only be started when the user issues the `INITiate<n>[:IMMediate]` command

Example: `CONF: BURS: SPEC: MASK`
Configures the Spectrum Mask measurement type.

Mode: WLAN

Manual operation: See "[Spectrum Mask \(IEEE 802.11ac, b, g \(Single Carrier\)\) / Spectrum IEEE/ETSI \(IEEE 802.11a, g, j, n \(OFDM\), p\)](#)" on page 78

CONFigure:BURSt:SPECtrum:MASK:SELect <Mode>

This remote control configures the interpretation of the Spectrum Mask measurement results. This command is only available for IEEE 802.11a & p.

Parameters:
<Mode> IEEE | ETSI

Example: `CONF: BURS: SPEC: MASK: SEL ETSI`
Interprets the measurement results using the ETSI standard.

Mode: WLAN

Manual operation: See "[Spectrum Mask \(IEEE 802.11ac, b, g \(Single Carrier\)\) / Spectrum IEEE/ETSI \(IEEE 802.11a, g, j, n \(OFDM\), p\)](#)" on page 78

CONFigure:BURSt:STATistics:BSTReam[:IMMediate]

This remote control command configures the measurement type to be Bitstream. After this command has been executed, the specified measurement will only be started when the user issues the `INITiate<n>[:IMMediate]` command.

Example: `CONF: BURS: STAT: BSTR`
Configures the Bitstream measurement type.

Mode: WLAN

Manual operation: See "[Bitstream](#)" on page 83

CONFigure:BURSt:STATistics:CCDF[:IMMediate]

This remote control command configures the measurement type to be CCDF (conditional cumulative distribution functions.). After this command has been executed, the specified measurement will only be started when the user issues the `INITiate<n>[:IMMediate]` command.

Example: `CONF: BURS: STAT: CCDF`
Configures the CCDF measurement type.

Mode: WLAN
Manual operation: See "CCDF" on page 83

CONFigure:BURSt:STATistics:SField[:IMMediate]

This remote control command configures the measurement type to be Signal Field. After this command has been executed, the specified measurement will only be started when the user issues the `INITiate<n>[:IMMediate]` command.

Example: `CONF:BURS:STAT:SField`
 Configures the Signal Field measurement type.

Mode: WLAN
Manual operation: See "Signal Field (IEEE 802.11a, ac, g (OFDM), j, n, p)" on page 85
 See "PLCP Header (IEEE 802.11b, g – Single Carrier)" on page 86

CONFigure:CHANnel <Channel>

This remote control command is used to specify the input channel for which measurements are to be performed. This command will automatically cause the internal measurement frequency to be re-calculated.

Parameters:
 <Channel> *RST: 0

Example: `CONF:CHAN 9`
 Specifies channel 9 as frequency measurement.

Mode: WLAN
Manual operation: See "Channel No " on page 88

CONFigure:POWer:AUTO <Mode>

This remote control command is used to switch on or off automatic power level detection. When switched on, power level detection is performed at the start of each measurement sweep.

Parameters:
 <Mode> ONCE | ON | OFF
 If this command is issued with the ONCE parameter then the auto level routine is performed immediately one time.

Example: `CONF:POW:AUTO ON`
 Configures the automatic detection of the input power level.

Mode: WLAN
Manual operation: See "Auto Lvl " on page 89
 See "Auto Level" on page 110

CONFigure:POWer:AUTO:SWEep:TIME <Time>

This remote control command is used to specify the sweep time for the automatic power level detection.

Parameters:

<Time> numeric value in seconds
*RST: 100ms

Example:

```
CONF:POW:AUTO:SWE:TIME 200MS
```

Configures a 200 ms sweep time for the auto-level detection.

Mode: WLAN

Manual operation: See ["Auto Lvl "](#) on page 89
See ["Auto Level Time "](#) on page 92

CONFigure:POWer:EXPEcted:RF <Level>

This remote control command is used to specify the mean power level of the source signal as supplied to the Analyzer RF input. This value will be overwritten if Auto Level is turned on.

Parameters:

<Level>

Example:

```
CONF:POW:EXP:RF 9
```

Assumes an input signal strength of 9 dBm.

Mode: WLAN

Manual operation: See ["Signal Level / Reference Level"](#) on page 88

CONFigure:POWer:EXPEcted:IQ <Level>

This remote control command is used to specify the mean power level of the source signal as supplied to the optional **Digital Baseband Interface (R&S FSV-B17)**. This value will be overwritten if Auto Level is turned on.

Parameters:

<Level>

Example:

```
CONF:POW:EXP:IQ 9 MV
```

Assumes an input signal strength of 9 mV.

Mode: WLAN

CONFigure:STANdard <Standard>

This remote control command specifies which Wireless LAN standard the option is configured to measure.

For details on supported standards see [chapter 3.1, "Introduction to WLAN 802.11A, AC, B, G, J, N & P TX Tests"](#), on page 12.

Parameters:

<Standard> 0 | 1 | 2 | 3 | 4 | 6 | 7

0
IEEE 802.11a

1
IEEE 802.11b

2
IEEE 802.11j (10 MHz)

3
IEEE 802.11j (20 MHz)

4
IEEE 802.11g

5
Turbo

6
IEEE 802.11n

7
IEEE 802.11n (MIMO)

8
IEEE 802.11ac

9
IEEE 802.11p

*RST: 0

Example:

```
CONF:STAN 0
```

Selects the IEEE 802.11a standard for the measurement.

Mode:

WLAN

Manual operation: See "[Standard](#)" on page 88

CONFigure:WLAN:ANTMatrix:ADDRess<RecPath> <Address>

This remote control command specifies the TCP/IP address for each receiver path in IPV4 format. Note, it is not possible to set the IP address of ANTMATRIX1 (Master)

Suffix:

<RecPath> 1..4
Defines the receiver path.

Parameters:

<Address> TCP/IP address in IPV4 format

Example:

```
CONF:WLAN:ANTM:ADDR2 '192.168.114.157'
```

Manual operation: See "[Analyzer IP Address](#)" on page 94

CONFigure:WLAN:ANTMatrix:ANTenna<RecPath> <Antenna>

This remote control command specifies the antenna assignment of the receive path.

Suffix:	
<RecPath>	1..4 Defines the receiver path.
Parameters:	
<Antenna>	ANTENNA1 ANTENNA2 Antenna assignment of the receiver path
Example:	CONF:WLAN:ANTM:ANT2 ANTENNA1
Manual operation:	See " Assignment " on page 94

CONFigure:WLAN:ANTMatrix:STATE<RecPath> State

This remote control command specifies the state of the receive path. Note, it is not possible to set the state of ANTMMatrix1 (Master).

Suffix:	
<RecPath>	1..4 Defines the receiver path.
Parameters:	
<State>	ON OFF State of the receive path
Example:	CONF:WLAN:ANTM:STAT2 ON
Manual operation:	See " State " on page 94

CONFigure:WLAN:DUTConfig <NoOfAnt>

This remote control command specifies the number of antennas used for MIMO measurement.

Parameters:	
<NoOfAnt>	TX1 TX2 TX3 TX4 TX1: one antenna, TX2: two antennas etc.
Example:	CONF:WLAN:DUTC TX1
Manual operation:	See " DUT MIMO configuration " on page 93

CONFigure:WLAN:EXTension:AUTO:TYPE <BurstType>

This remote control command specifies which bursts are analyzed according to extension spatial streams.

Parameters:

<BurstType>

The first burst is analyzed and subsequent bursts are analyzed only if they match

FBURst

The first burst is analyzed and subsequent bursts are analyzed only if they match

ALL

All bursts are analyzed

M0 | M1 | M2 | M3

Measure only if Ness 0 | 1 | 2 | 3

D0 | D1 | D2 | D3

Demod all as Ness 0 | 1 | 2 | 3

Example:

```
CONF:WLAN:EXT:AUTO:TYPE?
```

Manual operation:

See ["Extension spatial streams \(sounding\) \(IEEE 802.11ac or n \(MIMO\) only\)"](#) on page 108

CONFigure:WLAN:GTIMe:AUTO <State>

This remote control command specifies whether the guard time of the IEEE 802.11n (SISO) input signal is automatically detected or specified manually.

Parameters:

<State>

ON | OFF

*RST: OFF

Example:

```
CCONF:WLAN:GTIM:AUTO ON
```

Sets automatic detection of the guard time of the input signal

Mode:

WLAN

Manual operation:

See ["Auto Guard Interval \(IEEE 802.11n, SISO\)"](#) on page 100

CONFigure:WLAN:GTIMe:AUTO:TYPE <TYPE>

This remote control command specifies how bursts are analyzed according to guard length.

Note: In previous R&S FSV-K91 versions, this command configured both the guard interval type and the channel bandwidth. Now this command only configures the guard type. The channel bandwidth of the PPDU to be measured must be configured separately using the `[SENSe:]BANDwidth:CHANnel:AUTO:TYPE` command.

Parameters:

<TYPE>

FBURst

The guard length of the first PPDU is detected and subsequent bursts are analyzed only if they match.

("Auto, same type as first burst" in manual operation)

ALL

All PPDUs are analyzed regardless of guard length.

("Auto, individually for every burst" in manual operation)

MS

Only PPDUs with short guard interval length are analyzed.

(corresponds to "Meas only Short" in manual operation; MN8 | MN16 parameters in previous versions)

ML

Only bursts with long guard interval length are analyzed.

(corresponds to "Meas only Long" in manual operation; ML16 | ML32 parameters in previous versions)

DS

All bursts are demodulated assuming short guard interval length.

(corresponds to "Demod all as short" in manual operation; DN8 | DN16 parameters in previous versions)

DL

All bursts are demodulated assuming long guard interval length.

(corresponds to "Demod all as long" in manual operation; DL16 | DL32 parameters in previous versions)

Example:

```
CONF:WLAN:GTIM:AUTO:TYPE FBUR
```

Mode:

WLAN

Manual operation:

See "[Guard Interval Length](#)" on page 107

CONFigure:WLAN:GTIM:SElect <GuardTime>

This remote control command specifies the guard time of the IEEE 802.11n input signal. If the guard time is specified to be detected from the input signal using the [CONFigure:WLAN:GTIM:AUTO](#) command then this command is query only and allows the detected guard time to be obtained.

Parameters:

<GuardTime>

SHORT | NORMAl

SHORT

Only the PPDUs with short guard interval are analyzed.

NORMAl

Only the PPDUs with long guard interval are analyzed.

("Long" in manual operation)

*RST: NORMAl

Example:

```
CCONF:WLAN:GTIM:SEL SHOR
```

Measures signals with short guard times

Mode: WLAN (IEEE 802.11n)

Manual operation: See "[Guard Interval \(IEEE 802.11n, SISO\)](#)" on page 100

CONFigure:WLAN:MIMo:CAPTure <SignalPath>

Specifies the signal path to be captured in MIMO sequential manual measurements. Subsequently, use the [INITiate<n>\[:IMMEDIATE\]](#) command to start capturing data.

Parameters:

<SignalPath> RX1 | RX2 | RX3 | RX4

For details see "[Signal Capture](#)" on page 94

*RST: RX1

Example:

```
CONF:WLAN:DUTC TX4
```

Specify the number of antennas used for MIMO measurement as 2.

```
CONF:WLAN:MIMO:CAPT:TYPE MAN
```

Specify sequential MIMO measurement using manual operation. Pause the script and connect TX1 of the DUT to the analyzer. Continue the script

```
CONF:WLAN:MIM:CAPT RX1
```

Select RX1 for the next capture.

```
INIT:IMM
```

Capture the selected channel

Pause the script and connect TX2 of the DUT to the analyzer.

Continue the script

```
CONF:WLAN:MIM:CAPT RX2
```

Select RX2 for the next capture.

```
INIT:IMM
```

Capture the selected channel

```
CALC:BURS:IMM
```

Analyze the captured data

Mode: WLAN (IEEE 802.11ac/n (MIMO))

CONFigure:WLAN:MIMo[:CAPTure]:TYPE <Method>

Specifies the method used to analyze MIMO signals.

Parameters:

<Method>

SIMultaneous

Simultaneous normal MIMO operation

OSP

Sequential using open switch platform

MANual

Sequential using manual operation

*RST: SIM

Example:

```
CONF:WLAN:MIM:TYP SIM
```

Mode: WLAN (IEEE 802.11ac/n (MIMO))

Manual operation: See ["Signal Capture"](#) on page 94

CONFigure:WLAN:OSP:ADDRess <Address>

Specifies the TCP/IP address of the switch unit to be used for automated sequential MIMO measurements. The supported unit is Rohde & Schwarz OSP 1505.3009.03 with module option 1505.5101.02

Parameters:

<ID> TCP/IP address in dotted IPV4 format

Example: CONF:WLAN:MIM:OSP:ADDR '192.168.114.157'

Mode: WLAN (IEEE 802.11ac/n (MIMO))

Manual operation: See ["OSP IP Address"](#) on page 96

CONFigure:WLAN:OSP:MODule <ID>

Specifies the module of the switch unit to be used for automated sequential MIMO measurements. The supported unit is Rohde & Schwarz OSP 1505.3009.03 with module option 1505.5101.02

Parameters:

<ID> Module ID

*RST: A11

Example: CONF:WLAN:MIM:OSP:MOD A11

Mode: WLAN (IEEE 802.11ac/n (MIMO))

Manual operation: See ["OSP Switch Module"](#) on page 96

CONFigure:WLAN:PAYload:LENGth:SRC <Source>

Determines if the payload length should be taken from the signal field decoding result or from the signal (IEEE 802.11ac/n (MIMO)).

Parameters:

<Source> **ESTimate**
Signal

HTSignal
signal field decoding result

Example: CONF:WLAN:PAY:LEN:SRC EST
use signal

Manual operation: See ["Source of Payload Length"](#) on page 108

CONFigure:WLAN:PVERror:MRANge <Range>

This remote control command specifies whether the Peak Error Vector results are calculated over the complete burst or just over the PSDU.

This command is supported for 802.11b and 802.11g only.

Parameters:

<Range> **ALL**
Peak Error Vector results are calculated over the complete burst

PSDU
Peak Error Vector results are calculated over the PSDU only

*RST: ALL

Example:

CONF:WLAN:PVER:MRANge PSDU

Peak Error Vector results are calculated over the PSDU only

Mode: WLAN

Manual operation: See "[Meas Range \(IEEE 802.11b, g\)](#)" on page 93

CONFigure:WLAN:RSYNc:JOINed <State>

This command configures how burst synchronization and tracking is performed for multiple antennas.

Parameters:

<State> ON | OFF

ON
RX antennas are synchronized and tracked together.

OFF
RX antennas are synchronized and tracked separately.

*RST: OFF

Mode: WLAN (IEEE 802.11ac/n (MIMO))

Manual operation: See "[Joined RX Sync and Tracking](#)" on page 95

CONFigure:WLAN:SMAPping:MODE <Mode>

This remote control command specifies the special mapping mode.

Parameters:

<Mode> **DIRect**
direct

SEXPansion
expansion

USER
user defined

Example:

CONF:WLAN:SMAP:MODE DIR

Manual operation: See "[Spatial Mapping Mode](#)" on page 109

CONFigure:WLAN:SMAPping:NORMalise <State>

This remote control command specifies whether an amplification of the signal power due to the spatial mapping is performed according to the matrix entries. If this command is set to ON then the spatial mapping matrix is scaled by a constant factor to obtain a passive spatial mapping matrix which does not increase the total transmitted power. If this command is set to OFF the normalization step is omitted.

Parameters:

<State> ON/OFF

Example: CONF:WLAN:SMAP:NORM OFF

Manual operation: See "[Power Normalise](#)" on page 109

CONFigure:WLAN:SMAPping:TX<1...4> <STS.1 I>,<STS.1 Q>,<STS.2 I>,<STS.2 Q>,<STS.3 I>,<STS.3 Q>,<STS.4 I>,<STS.4 Q>,<TimeShift>

This remote control command specifies the mapping for all streams (real & imaginary data pairs) and timeshift for a specified antenna.

Suffix:

TX<1...4> Defines the TX antenna

Parameters:

<STS.1 I>, <STS.2 I>, Imag part of the complex element of the STS-Streams
<STS.3 I>, <STS.4 I>

<STS.1 Q>, <STS.2 Q>, Real part of the complex element of the STS-Streams
<STS.3 Q>, <STS.4 Q>

<TimeShift> Time shift (in s) for specification of user defined CSD (cyclic delay diversity) for the Spatial Mapping.

Range: -32 ns to 32 ns

Example: CONF:WLAN:SMAP:TX1 1.0,1.0, 2.0,2.0, 3.0,3.0, 4.0,4.0, 0

Manual operation: See "[User Defined Spatial Mapping](#)" on page 109

CONFigure:WLAN:SMAPping:TX<1...4>:STReam<1...4> <STS I>,<STS Q>

This remote control command specifies the mapping for a specific stream and antenna.

Suffix:

TX<1...4> Defines the TX antenna

STReam<1...4> Defines the stream

Parameters:

<STS I> Imag part of the complex element of the STS-Stream

<STS Q> Real part of the complex element of the STS-Stream

Example: CONF:WLAN:SMAP:TX1:STR1 1.0, 1.0

Manual operation: See ["User Defined Spatial Mapping"](#) on page 109

CONFigure:WLAN:SMAPping:TX<1...4>:TIMeshift <TimeShift>

This remote control command specifies the timeshift for a specific antenna.

Suffix:

TX<1...4> Defines the TX antenna

Parameters:

<TimeShift> Time shift (in s) for specification of user defined CSD (cyclic delay diversity) for the Spatial Mapping.
Range: -32 ns to 32 ns

Example: CONF:WLAN:SMAP:TX1:TIM 0

Manual operation: See ["User Defined Spatial Mapping"](#) on page 109

CONFigure:WLAN:STBC:AUTO:TYPE <BurstType>

This remote control command specifies which bursts are analyzed according to STBC streams.

Parameters:

<BurstType>

FBURst
First burst is analyzed and subsequent bursts are analyzed only if they match.

ALL
All bursts are analyzed.

M0 | M1 | M2
Measure only if STBC field = 0 | 1 | 2

D0 | D1 | D2
Demod all as STBC field = 0 | 1 | 2

Example: CONF:WLAN:STBC:AUTO:TYPE?

Manual operation: See ["STBC field"](#) on page 106

5.7 DISPlay Subsystem (WLAN)

The DISPLay subsystem controls the selection and presentation of textual and graphic information as well as of measurement data on the display. In contrast to the basic device, the WLAN TX Measurements option supports the split screen modus.

DISPlay[:WINDow<n>][:SUBWindow<m>]:SIZE.....	164
DISPlay[:WINDow<n>]:SSElect.....	164
DISPlay[:WINDow<n>]:TABLE.....	165
DISPlay[:WINDow<n>]:TRACe<t>:Y[:SCALE]:AUTO.....	165
DISPlay[:WINDow<n>]:TRACe<t>:Y[:SCALE]:PDIvision.....	166
DISPlay[:WINDow<n>]:TRACe<t>:Y[:SCALE]:RLEVel?.....	166

DISPlay[:WINDow<n>]:TRACe<t>:Y[:SCALe]:RLEVel[:RF].....	167
DISPlay[:WINDow<n>]:TRACe<t>:Y[:SCALe]:RLEVel:IQ.....	167
DISPlay[:WINDow<n>]:TRACe<t>:Y[:SCALe]:RLEVel:OFFSet.....	168

DISPlay[:WINDow<n>][:SUBWIndow<m>]:SIZE <Size>

This command configures the measurement display.

Suffix:

<n>	1 2 window; Channel and adjacent-channel power measurements: Only "1" is allowed as a suffix for the window. Spectrum Emission Mask and Spurious Emissions measurements: selects the window that is displayed in full size (if no suffix is defined, "1" is used): 1: diagram/result list 2: marker table
<m>	1 2 selects the item in the window to be displayed in full size: 1: diagram 2: result list

Parameters:

<Size>	LARGE SMALL LARGE Channel and adjacent-channel power measurements: diagram in full screen. Spectrum Emission Mask and Spurious Emissions measurements: diagram or list in full screen, depending on the value of the suffix. SMALL split screen (diagram and list and table) *RST: SMALL
--------	---

Example:

```
DISP:SIZE LARG
Displays the measurement diagram in full screen size.
DISP:WIND1:SUBW2:SIZE LARG
Displays the result list in full screen size.
DISP:WIND2:SIZE LARG
Displays the marker table in full screen size.
```

Mode: all

Manual operation: See "Screen Size Full/Split" on page 111

DISPlay[:WINDow<n>]:SSElect

This command selects whether screen A or screen B is active. SSElect means Screen SElect.

Suffix:
 <n> 1 | 2
 window; 1=A, 2=B

Parameters:
 *RST: 1

Example: DISP:WIND1:SSEL
 Sets the screen A active.

Mode: WLAN

Manual operation: See "Screen Focus A/B" on page 111

DISPlay[:WINDow<n>]:TABLe <State>

This command selects whether the results table is displayed.

Suffix:
 <n> 1 | 2
 window; 1=A, 2=B

Parameters:
 <State> ON | OFF
 *RST: ON

Example: DISP:WIND1:TABL ON
 Hides the results table

Mode: WLAN

Manual operation: See "Display List/Graph" on page 64

DISPlay[:WINDow<n>]:TRACe<t>:Y[:SCALe]:AUTO <State>

This command switches on or off automatic scaling of the Y-axis for the specified trace display. Automatic scaling sets the Y-axis to automatically scale to best fit the measurement results. This command is only available for the following result displays:

- EVM vs Carrier
- EVM vs Symbol.
- Frequency error vs Preamble
- Phase error vs Preamble

Suffix:
 <n> 2
 window; must be 2 as the relevant results are always displayed in screen B

<t> 1
 trace; must be 1

Parameters:

<State> ON | OFF
 *RST: ON

Example:

DISP:WIND2:TRAC:Y:SCAL:AUTO ON
 Switches on automatic scaling of the Y-axis for the active trace

Mode: WLAN

Manual operation: See "Y-Axis/Div" on page 75

DISPlay[:WINDow<n>]:TRACe<t>:Y[:SCALe]:PDIVision <Size>

This command sets the size of each Y scale division for the specified trace display. Note that this command has no affect if automatic scaling of the Y-axis is enabled. This command is only available for the following result displays:

- EVM vs Carrier
- EVM vs Symbol.
- Frequency error vs Preamble
- Phase error vs Preamble

Suffix:

<n> 2
 window; must be 2 as the relevant results are always displayed in screen B

<t> 1
 trace; must be 1

Parameters:

<Size> *RST: 3

Example:

DISP:WIND2:TRAC:Y:SCAL:DPIV 2
 Sets the Y scale division to size to 2.

Mode: WLAN

Manual operation: See "Y-Axis/Div" on page 75

DISPlay[:WINDow<n>]:TRACe<t>:Y[:SCALe]:RLEVel?

This command queries the current internal instrument reference level used when performing measurements.

Suffix:

<n> 1 | 2
 irrelevant

<t> 1...3
 irrelevant

Example:

DISP:TRAC:Y:RLEV?
 Returns the current reference level in use.

Usage: Query only
SCPI confirmed

Mode: WLAN

Manual operation: See "Ref Level " on page 92

DISPlay[:WINDow<n>]:TRACe<t>:Y[:SCALe]:RLEVel[:RF] <Level>

This command can be used to retrieve or set the current internal instrument reference level for RF input used when performing measurements.

Suffix:

<n> 1 | 2
irrelevant

<t> 1...3
irrelevant

Parameters:

<Level> <numeric value> in dB
*RST: -5 dB

Example:

DISP:TRAC:Y:RLEV?
Returns the current RF reference level in use.
DISP:TRAC:Y:RLEV: -20
Sets the instrument reference level to -20.

Mode: WLAN

DISPlay[:WINDow<n>]:TRACe<t>:Y[:SCALe]:RLEVel:IQ <Level>

This command can be used to retrieve or set the current internal instrument reference level for baseband input used when performing measurements.

Suffix:

<n> 1 | 2
irrelevant

<t> 1...3
irrelevant

Parameters:

<Level> <numeric value> in V
*RST: 1 V

Example:

DISP:TRAC:Y:IQ?
Returns the current baseband reference level in use.
DISP:TRAC:Y:RLEV:IQ 1
Sets the instrument reference level to 1.

Mode: WLAN

DISPlay[:WINDow<n>]:TRACe<t>:Y[:SCALe]:RLEVel:OFFSet <Value>

This command specifies the external attenuation/gain applied to measurements. The value corresponds to the reference level offset in the spectrum analyzer mode.

Suffix:

<n> 1 | 2
 irrelevant

<t> 1...3
 irrelevant

Parameters:

<Level> <numeric value> in dB
 *RST: 0 dB

Example:

DISP:TRAC:Y:RLEV:OFFS 10
External attenuation (level offset) of the analyzer is 10 dB.
DISP:TRAC:Y:RLEV:OFFS -10
External attenuation of the analyzer is -10 dB. i.e. a gain of 10 dB.

Mode: WLAN

5.8 FETCh Subsystem (WLAN)

The FETCh subsystem contains commands for reading out results of complex measurement tasks. This subsystem is closely linked to the CONFIGure and SENSE subsystems.

- 5.8.1 ASCII formats for returned values..... 168
- 5.8.2 Commands of the Fetch Subsystem (K91)..... 169

5.8.1 ASCII formats for returned values

The results are output as a list of result strings separated by commas.

Returned values for IEEE 802.11a, j, g(OFDM), n, p & Turbo Mode

<preamble power>, <payload power>, <min rms power>,
<average rms power>,<max rms power>, <peak power>,
<min crest factor>,<average crest factor>,<max crest factor>,
<min frequency error>,<average frequency error>, <max frequency error>,
<min symbol error>, <average symbol error>, <max symbol error>,
<min IQ offset>, <average IQ offset>, <maximum IQ offset>,
<min gain imbalance>, <average gain imbalance>, <max gain imbalance>,
<min quadrature offset>, <average quadrature offset>, <max quadrature offset>,

<min EVM all bursts>, <average EVM all bursts>, <max EVM all bursts>,
 <min EVM data carriers>, <average EVM data carriers >, <max EVM data carriers >
 <min EVM pilots>, <average EVM pilots >, <max EVM pilots >

Returned values for IEEE 802.11b & g (CCK)

<min rise time>,<average rise time>,<max rise time>,
 <min fall time>,<average fall time>,<max fall time>,
 <min rms power>,<average rms power>,<max rms power>,
 <min peak power>,<average peak power>,<max peak power>,
 <min crest factor>,<average crest factor>,<max crest factor>,
 <min frequency error>,<average frequency error>, <max frequency error>,
 <min chip clock error>, <average chip clock error>, <max chip clock error>,
 <min phase error>, <average phase error>, <max phase error>,
 <min IQ offset>, <average IQ offset>, <maximum IQ offset>,
 <min gain imbalance>, <average gain imbalance>, <max gain imbalance>,
 <min quadrature offset>, <average quadrature offset>, <max quadrature offset>,
 <min EVM IEEE>, <average EVM IEEE>, <max EVM IEEE>,
 <min EVM Direct>, <average EVM Direct >, <max EVM Direct >

5.8.2 Commands of the Fetch Subsystem (K91)

FETCh:BURSt:ALL?	170
FETCh:BURSt:BERPilot:DATA:AVERAge?	170
FETCh:BURSt:BERPilot:DATA:MAXimum?	170
FETCh:BURSt:BERPilot:DATA:MINimum?	170
FETCh:BURSt:COUNt[:ALL]?	171
FETCh:BURSt:CRESt[:AVERAge]?	171
FETCh:BURSt:CRESt:MAXimum?	171
FETCh:BURSt:CRESt:MINimum?	171
FETCh:BURSt:EVM:[IEEE]:AVERAge?	171
FETCh:BURSt:EVM:[IEEE]:MAXimum?	171
FETCh:BURSt:EVM:[IEEE]:MINimum?	171
FETCh:BURSt:EVM:ALL:AVERAge?	171
FETCh:BURSt:EVM:ALL:MAXimum?	171
FETCh:BURSt:EVM:ALL:MINimum?	171
FETCh:BURSt:EVM:DATA:AVERAge?	172
FETCh:BURSt:EVM:DATA:MAXimum?	172
FETCh:BURSt:EVM:DATA:MINimum?	172
FETCh:BURSt:EVM:DIReCt:AVERAge?	172
FETCh:BURSt:EVM:DIReCt:MAXimum?	172
FETCh:BURSt:EVM:DIReCt:MINimum?	172
FETCh:BURSt:EVM:PILot:AVERAge?	172

FETCh:BURSt:EVM:PILot:MAXimum?	172
FETCh:BURSt:EVM:PILot:MINimum?	172
FETCh:BURSt:FERRor:AVERage?	173
FETCh:BURSt:FERRor:MAXimum?	173
FETCh:BURSt:FERRor:MINimum?	173
FETCh:BURSt:GIMBalance:AVERage?	173
FETCh:BURSt:GIMBalance:MAXimum?	173
FETCh:BURSt:GIMBalance:MINimum?	173
FETCh:BURSt:IQOFset:AVERage?	173
FETCh:BURSt:IQOFset:MAXimum?	173
FETCh:BURSt:IQOFset:MINimum?	173
FETCh:BURSt:PAYLoad?	173
FETCh:BURSt:PEAK?	174
FETCh:BURSt:PREAmble?	174
FETCh:BURSt:QUADoffset:AVERage?	174
FETCh:BURSt:QUADoffset:MAXimum?	174
FETCh:BURSt:QUADoffset:MINimum?	174
FETCh:BURSt:RMS[:AVERage]?	174
FETCh:BURSt:RMS:MAXimum?	174
FETCh:BURSt:RMS:MINimum?	174
FETCh:BURSt:SYMBolerror:AVERage?	175
FETCh:BURSt:SYMBolerror:MAXimum?	175
FETCh:BURSt:SYMBolerror:MINimum?	175
FETCh:BURSt:TFALi:AVERage?	175
FETCh:BURSt:TFALi:MAXimum?	175
FETCh:BURSt:TFALi:MINimum?	175
FETCh:BURSt:TRISe:AVERage?	175
FETCh:BURSt:TRISe:MAXimum?	175
FETCh:BURSt:TRISe:MINimum?	175
FETCh:SYMBol:COUNT?	175

FETCh:BURSt:ALL?

This command returns all the results. The results are output as a list of result strings separated by commas in ASCII format. For details on the format refer to [chapter 5.8.1, "ASCII formats for returned values"](#), on page 168. The units for the EVM results are specified with the `UNIT:EVM` command.

Example: `FETC:BURS:ALL?`
All calculated results are returned.

Usage: Query only

Mode: WLAN

FETCh:BURSt:BERPilot:DATA:AVERage?

FETCh:BURSt:BERPilot:DATA:MAXimum?

FETCh:BURSt:BERPilot:DATA:MINimum?

This command returns the Burst Error Rate for PILOTS (average, minimum or maximum value) in % for the IEEE 802.11ac/n (MIMO) standard

Example: FETC: BURS: BERP: DATA: MAX?
Usage: Query only
Mode: WLAN

FETCh: BURSt: COUNt[:ALL]?

This command returns the number of analyzed bursts.

Example: FETC: BURS: COUN?
 The analyzed number of bursts is returned.
Usage: Query only
Mode: WLAN

FETCh: BURSt: CRESSt[:AVERAge]?**FETCh: BURSt: CRESSt: MAXimum?****FETCh: BURSt: CRESSt: MINimum?**

This command returns the average, minimum or maximum determined CREST factor (= ratio of peak power to average power) in dB.

Example: FETC: BURS: CRES: MAX?
 The maximum calculated crest factor from the most recent measurement is returned.
Usage: Query only
Mode: WLAN

FETCh: BURSt: EVM: [IEEE]: AVERAge?**FETCh: BURSt: EVM: [IEEE]: MAXimum?****FETCh: BURSt: EVM: [IEEE]: MINimum?**

This command returns the error vector magnitude measurement results summary (average, minimum or maximum value) in dB for the IEEE 802.11b standard. This result is the value before filtering.

Example: FETC: BURS: EVM: MAX?
 The maximum EVM recorded before filtering.
Usage: Query only
Mode: WLAN

FETCh: BURSt: EVM: ALL: AVERAge?**FETCh: BURSt: EVM: ALL: MAXimum?****FETCh: BURSt: EVM: ALL: MINimum?**

This command returns the error vector magnitude measurement results summary (average, minimum or maximum value) in dB. This is a combined figure that represents the pilot, data and the free carrier.

Example: FETC:BURS:EVM:ALL:MAX?
The maximum EVM recorded for all measurement carrier is returned.

Usage: Query only

Mode: WLAN

FETCh:BURSt:EVM:DATA:AVERAge?
FETCh:BURSt:EVM:DATA:MAXimum?
FETCh:BURSt:EVM:DATA:MINimum?

This command returns the error vector magnitude measurement results summary for the data carrier (average, minimum or maximum value) in dB.

Example: FETC:BURS:EVM:DATA:MAX?
The maximum EVM recorded for the data carrier is returned.

Usage: Query only

Mode: WLAN

FETCh:BURSt:EVM:DIRect:AVERAge?
FETCh:BURSt:EVM:DIRect:MAXimum?
FETCh:BURSt:EVM:DIRect:MINimum?

This command returns the error vector magnitude measurement results summary (average, minimum or maximum value) in dB for the IEEE 802.11b standard. This result is the value after filtering.

Example: FETC:BURS:EVM:DIR:MAX?
The maximum EVM recorded after filtering.

Usage: Query only

Mode: WLAN

FETCh:BURSt:EVM:PILot:AVERAge?
FETCh:BURSt:EVM:PILot:MAXimum?
FETCh:BURSt:EVM:PILot:MINimum?

This command returns the error vector magnitude measurement results summary for the EVM pilot carrier (average, minimum or maximum value) in dB.

Example: FETC:BURS:EVM:PIL:MAX?
The maximum EVM recorded for the EVM pilot carrier is returned.

Usage: Query only

Mode: WLAN

FETCh:BURSt:FERRor:AVERage?
FETCh:BURSt:FERRor:MAXimum?
FETCh:BURSt:FERRor:MINimum?

This command returns the measured average, minimum or maximum frequency errors in Hertz.

Example: `FETC:BURS:FERR:MAX?`
The maximum frequency error from the most recent measurement is returned.

Usage: Query only

Mode: WLAN

FETCh:BURSt:GIMBalance:AVERage?
FETCh:BURSt:GIMBalance:MAXimum?
FETCh:BURSt:GIMBalance:MINimum?

This command returns the measured average, minimum or maximum IQ Imbalance errors in dB.

Example: `FETC:BURS:GIMB:MAX?`
The maximum IQ Imbalance error from the most recent measurement is returned.

Usage: Query only

Mode: WLAN

FETCh:BURSt:IQOFfset:AVERage?
FETCh:BURSt:IQOFfset:MAXimum?
FETCh:BURSt:IQOFfset:MINimum?

This command returns the measured average, minimum or maximum IQ Offset errors in dB.

Example: `FETC:BURS:IQOF:MAX?`
The maximum IQ Offset error from the most recent measurement is returned.

Usage: Query only

Mode: WLAN

FETCh:BURSt:PAYLoad?

This command returns the measured power in the payload of the burst.

Example: `FETC:BURS:PAYL?`
The burst payload power is returned

Usage: Query only

Mode: WLAN

FETCh:BURSt:PEAK?

This command returns the Peak power in dBm measured during the measurement time.

Example: FETC: BURS: PEAK?
The calculated peak power from the most recent measurement is returned.

Usage: Query only

Mode: WLAN

FETCh:BURSt:PREamble?

This command returns the measured power in the burst preamble.

Example: FETC: BURS: PRE?
The burst preamble power is returned

Usage: Query only

Mode: WLAN

FETCh:BURSt:QUADoffset:AVERage?
FETCh:BURSt:QUADoffset:MAXimum?
FETCh:BURSt:QUADoffset:MINimum?

This command returns the accuracy in terms of the phase error of symbols within a burst.

Example: FETC: BURS: QUAD: MAX?
The maximum angle error recorded for a symbol during the measurement.

Usage: Query only

Mode: WLAN

FETCh:BURSt:RMS[:AVERage]?
FETCh:BURSt:RMS:MAXimum?
FETCh:BURSt:RMS:MINimum?

This command returns the average, minimum or maximum RMS burst power in dBm measured during the measurement.

Example: FETC: BURS: RMS: MAX?
The maximum calculated RSM burst power from the most recent measurement is returned.

Usage: Query only

Mode: WLAN

FETCh:BURSt:SYMBolerror:AVERAge?
FETCh:BURSt:SYMBolerror:MAXimum?
FETCh:BURSt:SYMBolerror:MINimum?

This command returns the percentage of symbols that were outside permissible demodulation range within a burst.

Example: `FETC:BURS:SYMB:MAX?`
The maximum number of symbols that were out of range per burst.

Usage: Query only

Mode: WLAN

FETCh:BURSt:TFALI:AVERAge?
FETCh:BURSt:TFALI:MAXimum?
FETCh:BURSt:TFALI:MINimum?

This command returns the average, minimum or maximum burst fall time in seconds.

Example: `FETC:BURS:TFAL:MAX?`
The maximum calculated fall time from the most recent measurement is returned.

Usage: Query only

Mode: WLAN

FETCh:BURSt:TRISe:AVERAge?
FETCh:BURSt:TRISe:MAXimum?
FETCh:BURSt:TRISe:MINimum?

This command returns the average, minimum or maximum burst rise time in seconds.

Example: `FETC:BURS:TRIS:MAX?`
The maximum calculated rise time from the most recent measurement is returned.

Usage: Query only

Mode: WLAN

FETCh:SYMBol:COUNt?

This command returns the number of symbols for each analyzed burst as a comma separated list.

Example: `FETC:SYMB:COUN?`
The analyzed number of symbols for each burst are returned

Usage: Query only

Mode: WLAN

5.9 FORMat Subsystem

FORMat[:DATA] <Format>

This command selects the data format for the data transmitted from the R&S FSV to the controlling computer. It is used for the transmission of trace data. The data format of trace data received by the instrument is automatically recognized, regardless of the format which is programmed.

(See also [TRACe\[:DATA\]?](#) on page 209).

Parameters:

<Format>

ASCIi

ASCII data are transmitted in plain text, separated by commas.

REAL

REAL data are transmitted as 32-bit IEEE 754 floating-point numbers in the "definite length block format".

UINT

In operating mode "WLAN" (R&S FSV-K91,91n option), bit stream data is sent as unsigned integers in binary format.

*RST: ASCII

Example:

```
FORM REAL, 32
FORM ASC
```

5.10 INITiate Subsystem

INITiate<n>:CONTInuous	176
INITiate<n>[:IMMEDIATE]	177

INITiate<n>:CONTInuous <State>

This command determines whether the trigger system is continuously initiated (continuous) or performs single measurements (single).

The sweep is started immediately.

Suffix:

<n> irrelevant

Parameters:

<State>

ON | OFF

*RST: ON

Example:

```
INIT:CONT OFF
Switches the sequence to single sweep.
INIT:CONT ON
Switches the sequence to continuous sweep.
```

Mode:

all

Manual operation: See "Run Single/Cont" on page 110

INITiate<n>[:IMMediate]

The command initiates a new measurement sequence.

With sweep count > 0 or average count > 0, this means a restart of the indicated number of measurements. With trace functions MAXHold, MINHold and AVERage, the previous results are reset on restarting the measurement.

In single sweep mode, you can synchronize to the end of the measurement with *OPC, *OPC? or *WAI. In continuous sweep mode, synchronization to the end of the measurement is not possible. Thus, it is not recommended that you use continuous sweep mode in remote control, as results like trace data or markers are only valid after a single sweep end synchronization.

Suffix:

<n> irrelevant

Example:

```
INIT:CONT OFF
```

Switches to single sweep mode.

```
DISP:WIND:TRAC:MODE AVER
```

Switches on trace averaging.

```
SWE:COUN 20
```

Setting the sweep counter to 20 sweeps.

```
INIT;*WAI
```

Starts the measurement and waits for the end of the 20 sweeps.

Mode: all

Manual operation: See "Capture" on page 96

5.11 INPut Subsystem

INPut:ATTenuation <Value>

This command programs the input attenuator. To protect the input mixer against damage from overloads, the setting 0 dB can be obtained by entering numerals, not by using the DOWN command.

The attenuation can be set in 5 dB steps (with option R&S FSV-B25: 1 dB steps). If the defined reference level cannot be set for the set RF attenuation, the reference level is adjusted accordingly.

In the default state with "Spectrum" mode, the attenuation set on the step attenuator is coupled to the reference level of the instrument. If the attenuation is programmed directly, the coupling to the reference level is switched off.

This function is not available if the R&S Digital I/Q Interface (R&S FSV-B17) is active.

Parameters:

<Value> *RST: 10 dB (AUTO is set to ON)

- Example:** `INP:ATT 30dB`
Sets the attenuation on the attenuator to 30 dB and switches off the coupling to the reference level.
- Mode:** all
- Manual operation:** See ["Ext Att"](#) on page 89
See ["Attenuation"](#) on page 93

INPut:DIQ:RANGe[:UPPer] <Level>

Defines or queries the "Full Scale Level", i.e. the level that should correspond to an I/Q sample with the magnitude "1".

It can be defined either in dBm or Volt (see ["Full Scale Level"](#) on page 92).

This command is only available if the optional R&S Digital I/Q Interface (option R&S FSV-B17) is installed.

For details see the R&S Digital I/Q Interface (R&S FSV-B17) description of the base unit.

Parameters:

<Level> <numeric value>
Range: 70.711 nV to 7.071 V
*RST: 1 V

- Example:** `INP:DIQ:RANG 1V`
- Mode:** A, IQ, NF, TDS, VSA, CDMA, EVDO, WCDMA, ADEMOD, GSM, OFDM, OFDMA/WiBro, WLAN
- Manual operation:** See ["Full Scale Level"](#) on page 92

INPut:DIQ:SRATe <SampleRate>

This command specifies or queries the sample rate of the input signal from the R&S Digital I/Q Interface (see ["Input Sample Rate"](#) on page 92).

This command is only available if the optional R&S Digital I/Q Interface (option R&S FSV-B17) is installed.

For details see the R&S Digital I/Q Interface (R&S FSV-B17) description of the base unit.

Parameters:

<SampleRate> Range: 1 Hz to 10 GHz
*RST: 32 MHz

- Example:** `INP:DIQ:SRAT 200 MHz`
- Mode:** A, IQ, NF, TDS, VSA, CDMA, EVDO, WCDMA, ADEMOD, GSM, OFDM, OFDMA/WiBro, WLAN
- Manual operation:** See ["Input Sample Rate"](#) on page 92

INPut:SElect <Source>

This command selects the signal source for measurements.

Parameters:

<Source>	RF DIQ
	RF
	Radio Frequency ("RF INPUT" connector)
	DIQ
	Digital IQ (only available with R&S Digital I/Q Interface, option R&S FSV-B17)
	*RST: RF

Example: INP:SEL RF

Mode: A, IQ, NF, TDS, VSA, CDMA, EVDO, WCDMA, ADEMOD, GSM, OFDM, OFDMA/WiBro, WLAN

Manual operation: See "Input" on page 91

5.12 INSTrument Subsystem (WLAN)

The INSTrument subsystem selects the operating mode of the unit either via text parameters or fixed numbers.

INSTrument[:SElect]	179
INSTrument:NSElect	179

INSTrument[:SElect] <Mode>**Parameters:**

<Mode>	WLAN
	Selects WLAN TX mode (R&S FSV-K91/91n/91ac/91p option)

INSTrument:NSElect <Mode>**Parameters:**

<Mode>	16
	Selects WLAN TX mode (R&S FSV-K91/91n/91ac/91p option)

5.13 MMEMory Subsystem (WLAN)

The MMEMory (mass memory) subsystem provides commands to store and load IQ data.

MMEMory:LOAD:IQ:STATe.....	180
MMEMory:LOAD:SEM:STATe 1,.....	180
MMEMory:STORe:IQ:STATe.....	180

MMEMory:LOAD:IQ:STATe 1, <FileName>

This command loads the I/Q data from the specified .iqw file.

Parameters:

<FileName> 1,<file_name>

Example:

```
MMEM:LOAD:IQ:STAT 1, 'C:
\R_S\Instr\user\data.iqw'
```

Loads IQ data from the specified file.

Usage: Setting only

Mode: WLAN

Manual operation: See "Import" on page 68

MMEMory:LOAD:SEM:STATe 1, <FileName>

This command loads a spectrum emission mask setup from an xml file.

Parameters:

<FileName> 1,<file_name>

Example:

```
MMEM:LOAD:SEM:STAT 1, 'D:\USER\ETSI_SEM.xml'
```

Loads a spectrum emission mask setup from the specified file.

Mode: WLAN

Manual operation: See "File Name" on page 81

MMEMory:STORe:IQ:STATe 1, <FileName>

This command stores the I/Q data to the specified .iqw file.

Parameters:

<FileName> 1,<file_name>

Example:

```
MMEM:STOR:IQ:STAT 1, 'C:
\R_S\Instr\user\data.iqw'
```

Stores I/Q data to the specified file.

Mode: WLAN

Manual operation: See "Export" on page 68

5.14 SENSe Subsystem (WLAN)

The SENSe command is used to set and get the values of parameters in the remote instrument. The get variant of the SENSe command differs from set in that it takes no parameter values (unless otherwise stated) but is followed by the character '?' and will return the parameter's value in the same format as it is set.

- 5.14.1 Analysis modulation format..... 181
- 5.14.2 Commands of the SENSe Subsystem..... 182

5.14.1 Analysis modulation format

The following modulation formats are available for analysis using R&S FSV-K91 (see also [[SENSe: \] DEMod: FORMat: BANalyze](#) on page 187):

Parameter	Standard	Description
'BPSK'	Alias for BI-Phase shift keying at higher data rate for selected standard	
'BPSK3'	IEEE 802.11j (10 MHz)	BI-Phase shift keying at 3 Mbps
'BPSK6'	IEEE 802.11a, g (OFDM), j (20 MHz) & Turbo	BI-Phase shift keying at 6 Mbps
'BPSK9'	IEEE 802.11a, g (OFDM), j (20 MHz) & Turbo	BI-Phase shift keying at 9 Mbps
'BPSK45'	IEEE 802.11j (10 MHz)	BI-Phase shift keying at 4.5 Mbps
'BPSK65'	IEEE 802.11n	BI-Phase shift keying at 6.5 Mbps
'BPSK72'	IEEE 802.11n	BI-Phase shift keying at 7.2 Mbps
'CCK11'	IEEE 802.11b & g (Single Carrier)	Complementary Code Keying at 11 Mbps
'CCK55'	IEEE 802.11b & g (Single Carrier)	Complementary Code Keying at 5.5 Mbps
'DBPSK1'	IEEE 802.11b & g (Single Carrier)	Differential BI-Phase shift keying
'DQPSK2'	IEEE 802.11b & g (Single Carrier)	Differential Quadrature phase shift keying
'PBCC11'	IEEE 802.11b & g (Single Carrier)	PBCC at 11 Mbps
'PBCC22'	IEEE 802.11g (Single Carrier)	PBCC at 11 Mbps
'PBCC55'	IEEE 802.11b & g (Single Carrier)	PBCC at 5.5 Mbps
'QAM16'	Alias for Quadrature Amplitude Modulation at higher data rate for selected standard	
'QAM64'	Alias for Quadrature Amplitude Modulation at higher data rate for selected standard	
'QAM1612'	IEEE 802.11j (10 MHz)	Quadrature Amplitude Modulation at 12 Mbps
'QAM1618'	IEEE 802.11j (10 MHz)	Quadrature Amplitude Modulation at 18 Mbps
'QAM1624'	IEEE 802.11a, g (OFDM), j (20 MHz) & Turbo	Quadrature Amplitude Modulation at 24 Mbps
'QAM1626'	IEEE 802.11n	Quadrature Amplitude Modulation at 26 Mbps

'QAM1636'	IEEE 802.11a, g (OFDM), j (20 MHz) & Turbo	Quadrature Amplitude Modulation at 36 Mbps
'QAM1639'	IEEE 802.11n	Quadrature Amplitude Modulation at 39 Mbps
'QAM16289'	IEEE 802.11n	Quadrature Amplitude Modulation at 28.9 Mbps
'QAM16433'	IEEE 802.11n	Quadrature Amplitude Modulation at 43.3 Mbps
'QAM6424'	IEEE 802.11j (10 MHz)	Quadrature Amplitude Modulation at 24 Mbps
'QAM6427'	IEEE 802.11j (10 MHz)	Quadrature Amplitude Modulation at 27 Mbps
'QAM6448'	IEEE 802.11a, g (OFDM), j (20 MHz) & Turbo	Quadrature Amplitude Modulation at 48 Mbps
'QAM6452'	IEEE 802.11n	Quadrature Amplitude Modulation at 52 Mbps
'QAM6454'	IEEE 802.11a, g (OFDM), j (20 MHz) & Turbo	Quadrature Amplitude Modulation at 54 Mbps
'QAM6465'	IEEE 802.11n	Quadrature Amplitude Modulation at 65 Mbps
'QAM16289'	IEEE 802.11n	Quadrature Amplitude Modulation at 28.9 Mbps
'QAM16433'	IEEE 802.11n	Quadrature Amplitude Modulation at 43.3 Mbps
'QAM64578'	IEEE 802.11n	Quadrature Amplitude Modulation at 57.8 Mbps
'QAM64585'	IEEE 802.11n	Quadrature Amplitude Modulation at 58.5 Mbps
'QAM64722'	IEEE 802.11n	Quadrature Amplitude Modulation at 72.2 Mbps
'QPSK'	Alias for Quadrature phase shift keying at higher data rate for selected standard	
'QPSK6'	IEEE 802.11j (10 MHz)	Quadrature phase shift keying at 6 Mbps
'QPSK9'	IEEE 802.11j (10 MHz)	Quadrature phase shift keying at 9 Mbps
'QPSK12'	IEEE 802.11a, g (OFDM), j (20 MHz) & Turbo	Quadrature phase shift keying at 12 Mbps
'QPSK13'	IEEE 802.11n	Quadrature phase shift keying at 13 Mbps
'QPSK18'	IEEE 802.11a, g (OFDM), j (20 MHz) & Turbo	Quadrature phase shift keying at 18 Mbps
'QPSK144'	IEEE 802.11n	Quadrature phase shift keying at 14.4 Mbps
'QPSK195'	IEEE 802.11n	Quadrature phase shift keying at 19.5 Mbps
'QPSK217'	IEEE 802.11n	Quadrature phase shift keying at 21.7 Mbps

5.14.2 Commands of the SENSe Subsystem

[SENSe:]BANDwidth:CHANnel:AUTO:TYPE.....	183
[SENSe:]BANDwidth[:RESolution]:FILTer.....	184
[SENSe:]BURSt:COUNt.....	185

[SENSe:]BURSt:COUNT:STATe.....	185
[SENSe:]DEMod:CEStimation.....	185
[SENSe:]DEMod:FFT:OFFSet.....	186
[SENSe:]DEMod:FILTer:CATalog?.....	186
[SENSe:]DEMod:FILTer:EFLength.....	186
[SENSe:]DEMod:FILTer:MODulation.....	187
[SENSe:]DEMod:FORMat:BANalyze.....	187
[SENSe:]DEMod:FORMat:BANalyze:BTYPe.....	187
[SENSe:]DEMod:FORMat:BANalyze:BTYPe:AUTO:TYPE.....	188
[SENSe:]DEMod:FORMat:BANalyze:DBYTes:EQUal.....	189
[SENSe:]DEMod:FORMat:BANalyze:DBYTes:MAX.....	190
[SENSe:]DEMod:FORMat:BANalyze:DBYTes:MIN.....	190
[SENSe:]DEMod:FORMat:BANalyze:DURation:EQUal.....	191
[SENSe:]DEMod:FORMat:BANalyze:DURation:MAX.....	191
[SENSe:]DEMod:FORMat:BANalyze:DURation:MIN.....	191
[SENSe:]DEMod:FORMat:BANalyze:SYMBols:EQUal.....	192
[SENSe:]DEMod:FORMat:BANalyze:SYMBols:MAX.....	192
[SENSe:]DEMod:FORMat:BANalyze:SYMBols:MIN.....	193
[SENSe:]DEMod:FORMat[:BContent]:AUTO.....	193
[SENSe:]DEMod:FORMat:BRate.....	194
[SENSe:]DEMod:FORMat:MCSIndex.....	194
[SENSe:]DEMod:FORMat:MCSIndex:MODE.....	194
[SENSe:]DEMod:FORMat:NSTsindex.....	195
[SENSe:]DEMod:FORMat:NSTsindex:MODE.....	195
[SENSe:]DEMod:FORMat:SIGSymbol.....	196
[SENSe:]DEMod:TXARea.....	196
[SENSe:]FREQuency:CENTer.....	197
[SENSe:]POWer:ACHannel:MODE.....	197
[SENSe:]POWer:SEM:CLASs.....	198
[SENSe:]POWer:SEM.....	198
[SENSe:]POWer:SEM:TRACe:REDUction.....	200
[SENSe:]SWAPiq.....	200
[SENSe:]SWEep:COUNT.....	200
[SENSe:]SWEep:EGATe.....	201
[SENSe:]SWEep:EGATe:HOLDoff[:TIME].....	201
[SENSe:]SWEep:EGATe:HOLDoff:SAMPle.....	201
[SENSe:]SWEep:EGATe:LENGth[:TIME].....	202
[SENSe:]SWEep:EGATe:LENGth:SAMPle.....	202
[SENSe:]SWEep:EGATe:LINK.....	202
[SENSe:]SWEep:TIME.....	203
[SENSe:]SWEep:EGATe:TYPE.....	203
[SENSe:]TRACking:LEVel.....	203
[SENSe:]TRACking:PHASe.....	203
[SENSe:]TRACking:PILots.....	204
[SENSe:]TRACking:TIME.....	204

[SENSe:]BANDwidth:CHANnel:AUTO:TYPE <Analysis>

This remote control command specifies how bursts are analyzed according to channel bandwidth.

Parameters:

<parameter>

FBURst

The channel bandwidth of the first valid bursts is detected and subsequent bursts are analyzed only if they have the same channel bandwidth.

ALL

All bursts are analyzed regardless of their channel bandwidth

MB20

Only bursts with a channel bandwidth of 20MHz are analyzed

MB40

Only PPDU's within a channel bandwidth of 40MHz are analyzed
(IEEE 802.11 n, ac only)

MB80

Only PPDU's within a channel bandwidth of 80MHz are analyzed
(IEEE 802.11 ac only)

MB160

Only PPDU's within a channel bandwidth of 160MHz are analyzed
(IEEE 802.11 ac only)

DB20

All bursts are analyzed according to a channel bandwidth of 20MHz

DB40

All PPDU's are analyzed within a channel bandwidth of 40MHz
(IEEE 802.11 n, ac only)

DB80

All PPDU's are analyzed within a channel bandwidth of 80MHz
(IEEE 802.11 n, ac only)

DB160

All PPDU's are analyzed within a channel bandwidth of 160MHz
(IEEE 802.11 n, ac only)

*RST: FBURst

Example:

```
SENS:BAND:CHAN:AUTO:TYPE ALL
```

Mode:

WLAN

Manual operation:

See "[Channel Bandwidth to measure](#)" on page 105

[SENSe:]BANDwidth[:RESolution]:FILTer <State>

This remote control command enables or disables use of the RBW filter

Parameters:

<State>

ON | OFF

*RST: OFF

Example:

```
SENS:BAND:RES:FILT ON
```

Mode:

WLAN

Manual operation: See "[Filter adjacent channels \(IEEE 802.11ac, n \(MIMO\)\)](#)" on page 102

[SENSe:]BURSt:COUNt <NoOfBursts>

This command defines the number of bursts that will be analyzed by the measurement. This parameter is ignored if the setting for the [SENSe:]BURSt:COUNt:STATe on page 185 parameter is off.

Parameters:

<NoOfBursts> *RST: 1

Example:

BURSt:COUN 16
Sets the number of bursts to 16.

Mode: WLAN

Manual operation: See "[Analyze PPDUs](#) " on page 89

[SENSe:]BURSt:COUNt:STATe <State>

When this command is set to on, the burst count parameter will be used by the measurement, otherwise the burst count parameter will be ignored.

Parameters:

<State> ON | OFF
*RST: OFF

Example:

BURSt:COUN:STAT ON
Sets the burst count state to ON

Mode: WLAN

Manual operation: See "[PPDU Count](#) " on page 89

[SENSe:]DEMod:CEStimation <State>

This command defines whether channel estimation will be done in preamble and payload (if set to 1) or only in preamble (if set to 0). The effect of this is most noticeable for the EVM measurement results, where the results will be improved when this feature is enabled.

However, this functionality is not supported by the IEEE 802.11 standard and must be disabled if the results are to be strictly measured against the standard.

Parameters:

<State> ON | OFF
*RST: OFF

Example:

DEMod:CESt ON
Specifies that the IQ measurement results will use channel estimation in preamble & payload.

Mode: WLAN

Manual operation: See "[Channel Estimation Range \(IEEE 802.11a, ac, g \(OFDM\), j, n, p\)](#)" on page 101

[SENSe:]DEMod:FFT:OFFSet <Mode>

This command specifies the FFT start offset.

Parameters:

<Mode>

AUTO

The FFT start offset is automatically chosen to minimize the intersymbol interference.

GICenter

Guard Interval Center: The FFT start offset is placed to the center of the guard interval.

PEAK

The peak of the fine timing metric is used to determine the FFT start offset.

Mode: WLAN

Manual operation: See "[FFT Start Offset \(IEEE 802.11a, g, j, p\)](#)" on page 104
See "[FFT Start Offset](#)" on page 108

[SENSe:]DEMod:FILTer:CATalog?

This command reads the names of all available filters.

Parameters:

<Result> <filter_1>,< filter_2>, ..., <filter_n>

The file names are output without the file extension.

Example:

```
DEM:FILT:CAT?
Reads all filter names
```

Usage: Query only

Mode: WLAN

[SENSe:]DEMod:FILTer:EFLength <Length>

This command specifies the equalizer filter length in chips.

Parameters:

<Length> numeric value

*RST: 10

Example:

```
DEM:FILT:EFL 4
Sets the equalizer filter length to 4 chips.
```

Mode: WLAN

Manual operation: See "[Equalizer Filter Len.](#) " on page 104

[SENSe:]DEMod:FILTer:MODulation <TXFilter>, <RXFilter>

This command selects the TX and RX filters. The names of the filters correspond to the file names; a query of all available filters is possible by means of the [\[SENSe:\]DEMod:FILTer:CATalog?](#) on page 186 command.

Parameters:

<TXFilter>, *RST: AUTO,AUTO
<RXFilter> DEF_TX: default transmit filter, DEF_RX: default receive filter

Example:

```
DEM:FILT:MOD 'DEF_TX', 'DEF_RX'
```

DEF_TX is selected for the TX filter and DEF_RX for the RX filter

Mode: WLAN

Manual operation: See "Transmit Filter" on page 103
See "Receive Filter" on page 103

[SENSe:]DEMod:FORMat:BANalyze <Format>

The remote control command sets the analysis modulation format that will be assumed when the measurement is performed. If the [\[SENSe:\]DEMod:FORMat:SIGSymbol](#) on page 196 parameter has been set to ON, this command can be used to measure only certain burst types within a measurement sequence.

For IEEE 802.11n this command is only supported for SISO. For IEEE 802.11n (MIMO) use: [\[SENSe:\]DEMod:FORMat:MCSIndex](#) on page 194:

Parameters:

<Format> *RST: QAM64
For details refer to [chapter 5.14.2, "Commands of the SENSe Subsystem"](#), on page 182.

Example:

```
DEM:FORM:BAN 'QAM16'
```

Only bursts that are of the QAM16 modulation format are analyzed.

Mode: WLAN

Manual operation: See "Analyze PSDU Mod (IEEE 802.11n, SISO)" on page 99
See "Demodulator (IEEE 802.11a, b, g, j, p)" on page 100

[SENSe:]DEMod:FORMat:BANalyze:BTYPe <BurstType>

This remote control command specifies the type of burst to be analyzed. Only bursts of the specified type take part in measurement analysis.

Parameters:

<BurstType>

DIRECT | LONG-OFDM | SHORT-OFDM | LONG | SHORT |
MM20 | GFM20 | MM40 | GFM40**DIRECT**IEEE 802.11a, p, IEEE 802.11j (10MHz), IEEE 802.11j (20MHz),
IEEE 802.11g, 802.11 OFDM Turbo – Direct Link Burst**LONG-OFDM**

IEEE 802.11g – Long DSSS OFDM

SHORT-OFDM

IEEE 802.11g – Short DSSS OFDM

LONG

IEEE 802.11b, IEEE 802.11g – Long PLCP Burst

SHORT

IEEE 802.11b, IEEE 802.11g – Short PLCP Burst

MM20

IEEE 802.11n, Mixed Mode, 20 MHz sampling rate

GFM20

IEEE 802.11n Green Field Mode, 20 MHz sampling rate

MM40

IEEE 802.11n, Mixed Mode, 40 MHz sampling rate

GFM40

IEEE 802.11n Green Field Mode, 40 MHz sampling rate

*RST: DIRECT

Example:

DEM:FORM:BA:NALYZE:BTYPe 'DIRECT'

Only DIRECT bursts are analyzed.

Mode:

WLAN

Manual operation:See "[PPDU Type \(IEEE 802.11a, g \(OFDM, Single Carrier\), j, n, p\)](#)" on page 98See "[Preamble Type \(IEEE 802.11b\)](#)" on page 99See "[PPDU Frame Format \(IEEE 802.11n, SISO\)](#)" on page 99

[SENSe:]DEMod:FORMat:BAAnalyze:BTYPe:AUTO:TYPE <Analysis>

This remote control command specifies how signals are analyzed (IEEE IEEE 802.11ac, n (MIMO) only).

Parameters:

<Analysis>

FBURst

The format of the first valid PPDU is detected and subsequent PDUs are analyzed only if they have the same format (corresponds to "Auto, same type as first PDU")

ALL

All PDUs are analyzed regardless of their format (corresponds to "Auto, individually for each PDU")

MNHT

Only PDUs with format "Non-HT" are analyzed

(IEEE 802.11 a)

DNHT

All PDUs are assumed to have the PDU format "Non-HT"

(IEEE 802.11 a)

MMIX

Only PDUs with format "HT-MF" (Mixed) are analyzed

(IEEE 802.11 n)

MGRF

Only PDUs with format "HT-GF" (Greenfield) are analyzed

(IEEE 802.11 n)

DMIX

All PDUs are assumed to have the PDU format "HT-MF"

(IEEE 802.11 n)

DGRF

All PDUs are assumed to have the PDU format "HT-GF"

(IEEE 802.11 n)

MVHT

Only PDUs with format "VHT" are analyzed

(IEEE 802.11 ac)

DVHT

All PDUs are assumed to have the PDU format "VHT"

(IEEE 802.11 ac)

*RST: FBURst

Example:

SENS:DEM:FOR:BAN:BTYP:AUTO:TYPE FBUR

Mode:

WLAN

Manual operation: See ["PDU format to measure"](#) on page 104

[SENSe:]DEMod:FORMat:BANalyze:DBYTes:EQUal <State>

When this command is set to ON then only bursts of equal length will take part in the measurement analysis. The number of data bytes that a burst must have in order to take part in measurement analysis is specified by the [\[SENSe:\]DEMod:FORMat:BANalyze:DBYTes:MIN](#) on page 190 command.

Parameters:

<State> ON | OFF
 *RST: OFF

Example:

DEM:FORM:BAN:DBYTES:EQU ON

Only bursts of equal length will take part in the measurement analysis.

Mode: WLAN

Manual operation: See "Equal PDU Length" on page 100

[SENSe:]DEMod:FORMat:BANalyze:DBYTES:MAX <NumberDataBytes>

This command specifies the maximum number of data bytes required for bursts to qualify for measurement analysis. Only bursts with the specified number of data bytes will be used in the measurement analysis.

This value will not have any immediate effect if the [SENSe:]DEMod:FORMat:BANalyze:DBYTES:EQUal on page 189 command has been set to ON. In this case, no range of symbols is allowed and only bursts with exactly the number of data bytes specified by the [SENSe:]DEMod:FORMat:BANalyze:DBYTES:MIN on page 190 command shall take part in measurement analysis.

Parameters:

<NumberDataBytes> *RST: 64

Example:

DEM:FORM:BAN:DBYTES:MAX 1300

Only bursts which contain a maximum of 1300 data bytes are analyzed.

Mode: WLAN

Manual operation: See "Max Payload Length (IEEE 802.11b, g)" on page 102

[SENSe:]DEMod:FORMat:BANalyze:DBYTES:MIN <NumberDataBytes>

This command specifies the number of data bytes required for bursts to qualify for measurement analysis. Only bursts with the specified number of data bytes will be used in the measurement analysis.

If the [SENSe:]DEMod:FORMat:BANalyze:DBYTES:EQUal on page 189 command has been set to ON, this command specifies the exact number of data bytes required for a burst to take part in measurement analysis. If the [SENSe:]DEMod:FORMat:BANalyze:DBYTES:EQUal on page 189 command is set to OFF, this command specifies the minimum number of data bytes required for a burst to take part in measurement analysis.

Parameters:

<NumberDataBytes> *RST: 1

Example:

DEM:FORM:BAN:DBYTES:MIN 16

Only bursts which contain 16 data bytes are analyzed.

Mode: WLAN

Manual operation: See "Payload Length (IEEE 802.11b, g)" on page 102
See "Min Payload Length (IEEE 802.11b, g)" on page 102

[SENSe:]DEMod:FORMat:BANalyze:DURation:EQUal <State>

When this command is set to ON then only bursts of equal length will take part in the PVT analysis. When this command is set to true the value specified by the [SENSe:]DEMod:FORMat:BANalyze:DURation:MIN on page 191 command specifies the duration that a burst must last in order to take part in measurement analysis.

Parameters:

<State> ON | OFF
*RST: OFF

Example:

DEM: BAN: DUR: EQU ON
Only bursts of equal length will take part in the measurement analysis.

Mode: WLAN

Manual operation: See "Equal PPDU Length" on page 100

[SENSe:]DEMod:FORMat:BANalyze:DURation:MAX <Duration>

This command specifies the maximum duration in microseconds required for bursts to qualify for measurement analysis. Only bursts with the specified duration will be used in the measurement analysis.

This value will not have any immediate effect if the [SENSe:]DEMod:FORMat:BANalyze:DURation:EQUal on page 191 command has been set to true as in this case no range of durations is allowed and only bursts with exactly the duration specified by the [SENSe:]DEMod:FORMat:BANalyze:DURation:MIN on page 191 command shall take part in measurement analysis

Parameters:

<Duration> *RST: 5464

Example:

DEM: BAN: DUR: MAX 1300
Only bursts which have a maximum duration of 1300 microseconds are analyzed.

Mode: WLAN

Manual operation: See "Max Payload Length (IEEE 802.11b, g)" on page 102

[SENSe:]DEMod:FORMat:BANalyze:DURation:MIN <Duration>

This command specifies the duration in microseconds required for bursts to qualify for measurement analysis. Only bursts with the specified duration will be used in the measurement analysis.

If the `[SENSe:]DEMod:FORMat:BANalyze:DURation:EQUal` on page 191 command has been set to true then this command specifies the exact duration required for a burst to take part in measurement analysis.

If the `[SENSe:]DEMod:FORMat:BANalyze:DBYTes:EQUal` on page 189 command is set to false this command specifies the minimum duration required for a burst to take part in measurement analysis.

Parameters:

<Duration> *RST: 1

Example:

DEM: BAN: DUR: MIN 45
Only bursts which last 48 microseconds are analyzed.

Mode: WLAN

Manual operation: See "Payload Length (IEEE 802.11b, g)" on page 102
See "Min Payload Length (IEEE 802.11b, g)" on page 102

[SENSe:]DEMod:FORMat:BANalyze:SYMBols:EQUal <State>

When this command is activated then only bursts of equal length will take part in the measurement analysis. When this command is set to true the value specified by the `[SENSe:]DEMod:FORMat:BANalyze:SYMBols:EQUal` on page 192 command specifies the number of symbols that a burst must have in order to take part in analysis.

Parameters:

<State> ON | OFF
*RST: OFF

Example:

DEM: FORM: BAN: SYM: EQU ON
Only bursts of equal length will take part in analysis.

Mode: WLAN

Manual operation: See "Equal PPDU Length" on page 100

[SENSe:]DEMod:FORMat:BANalyze:SYMBols:MAX <NumberDataSymbols>

This command specifies the maximum number of data symbols required for bursts to qualify for measurement analysis. Only bursts with the specified number of symbols will be used in the measurement analysis. The number of data symbols is defined as the uncoded bits including service and tail bits.

This value will not have any immediate effect if the `[SENSe:]DEMod:FORMat: BANalyze:SYMBols:EQUal` command has been set to true as in this case no range of symbols is allowed and only bursts with exactly the number of symbols specified by the `[SENSe:]DEMod:FORMat:BANalyze:SYMBols:MIN` command shall take place in measurement analysis.

Parameters:

<NumberDataSymbols>*RST: 64

Example:	DEM:FORM:BAN:SYM:MAX 1300 Only bursts which contain a maximum symbol count of 1300 are analyzed.
Mode:	WLAN
Manual operation:	See " Max Data Symbols (IEEE 802.11a, ac, j, n, p) " on page 101

[SENSe:]DEMod:FORMat:BANalyze:SYMBols:MIN <NumberDataSymbols>

This command specifies the number of data symbols required for bursts to qualify for measurement analysis. Only bursts with the specified number of symbols will be used in the measurement analysis. The number of data symbols is defined as the uncoded bits including service and tail bits.

When the [\[SENSe:\]DEMod:FORMat:BANalyze:SYMBols:EQUal](#) command has been set to true then this command specifies the exact number of symbols required for a burst to take part in measurement analysis. When the [\[SENSe:\]DEMod:FORMat:BANalyze:SYMBols:EQUal](#) command is set to false this command specifies the minimum number of symbols required for a burst to take part in measurement analysis.

Parameters:

<NumberDataSymbols>*RST: 1

Example: DEM:FORM:BAN:SYM:MIN 16
Only bursts which contain a symbol count of 16 are analyzed.

Mode: WLAN

Manual operation: See "[Data Symbols \(IEEE 802.11a, ac, j, n, p\)](#)" on page 101
See "[Min Data Symbols \(IEEE 802.11a, ac, j, n, p\)](#)" on page 101

[SENSe:]DEMod:FORMat[:BContent]:AUTO <State>

When this command is set to ON, the signal symbol field, resp. the PLCP header field of the burst is analyzed to determine the details of the burst. When this field is set to ON, only bursts that match the supplied burst type and modulation are considered in results analysis.

Parameters:

<State> ON | OFF

Example: DEM:FORM:AUTO ON
Specifies that the signal symbol field should be decoded.

Mode: WLAN

Manual operation: See "[Demod Settings \(IEEE 802.ac, n \(MIMO\) only\)](#)" on page 98
See "[Auto Demodulation \(IEEE 802.11n, SISO\)](#)" on page 99

[SENSe:]DEMod:FORMat:BTRate <BitRate>

The remote control command is used to specify the bit rate for IEEE 802.11b signals. This command can be used as an alternative to [\[SENSe:\]DEMod:FORMat:BANalyze](#) on page 187. The bit rate can be set as follows:

Parameters:

<BitRate> 10 | 20 | 55 | 110
 10
 1 Mbit/s
 20
 2 Mbit/s
 55
 5.5 Mbit/s
 110
 11 Mbit/s
 *RST: 10 (= 1mbit)

Example: DEM:FORM:BTR 20
 Configures to demodulate 2 Mbit/s signals

Mode: WLAN

[SENSe:]DEMod:FORMat:MCSIndex <Index>

This command accesses the MCS-Index which controls the rate and modulation and streams. It is used as the offset in the available options as shown on control or MCS parameter tables (see document: IEEE P802.11n/D11.0 June 2009).

Parameters:

<Index> numeric value
 *RST: 1

Example: SENS:DEMod:FORM:MCSI 1
 selects MCS-Index 1 (BPSK 1 spatial stream)

Mode: WLAN

Manual operation: See "[MCS Index](#)" on page 106

[SENSe:]DEMod:FORMat:MCSIndex:MODE <Analysis>

This remote control command specifies how bursts are analyzed according to the MCS index

Parameters:

<Analysis>

FBURst

The MCS index of the first burst is detected and subsequent bursts are analyzed only if they have the same MCS index

ALL

All valid bursts are analyzed according to their individual MCS indexes

MEASure

Only bursts with an MCS index which matches that supplied by `SENSe:]DEMod:FORMat:MCSIndex` will be analyzed

DEMod

All bursts will be analyzed according to the MCS index specified by `[SENSe:]DEMod:FORMat:MCSIndex` on page 194.

*RST: FBURst

Example:

```
SENS:DEMod:FORMat:MCSI:MOD ALL
selects MCS-Index 1 (BPSK 1 spatial stream)
```

Mode:

WLAN

Manual operation: See "[MCS Index to use](#)" on page 105

[SENSe:]DEMod:FORMat:NSTSindex <Index>

Defines the the PPDUs taking part in the analysis depending on their Nsts.

This command is only available for the **IEEE 802.11 ac** standard.

This command is available for `DEMod:FORMat:NSTS:MODE MEAS` or `DEMod:FORMat:NSTS:MODE DEM` (see `[SENSe:]DEMod:FORMat:NSTSindex:MODE` on page 195).

Parameters:

<Index>

Example:

```
SENS:DEMod:FORMat:NSTS:MODE MEAS
SENS:DEMod:FORMat:NSTS 1
```

Manual operation: See "[Nsts \(IEEE 802.11ac only\)](#)" on page 106

[SENSe:]DEMod:FORMat:NSTSindex:MODE <Mode>

Defines the the PPDUs taking part in the analysis depending on their Nsts.

This command is only available for the **IEEE 802.11 ac** standard.

Parameters:

<Mode>

FBURst | ALL | MEASure | DEMod

FBURst

The Nsts of the first PPDU is detected and subsequent PPDUs are analyzed only if they have the same Nsts (corresponds to "Auto, same type as first PPDU")

ALL

All recognized PPDUs are analyzed according to their individual Nsts (corresponds to "Auto, individually for each PPDU")

MEASure

Only PPDUs with the Nsts specified by [SENSe:]DEMod:FORMat:NSTSiNdex are analyzed

DEMod

The "Nsts" index specified by [SENSe:]DEMod:FORMat:NSTSiNdex is used for all PPDUs.

*RST: FBURst

Example:

SENS:DEM:FORM:NSTS:MODE MEAS

SENS:DEM:FORM:NSTS 1

Manual operation: See "Nsts to use (IEEE 802.11 ac only)" on page 106**[SENSe:]DEMod:FORMat:SIGSymbol <State>**

If this command is set to ON, the signal symbol field of the burst is analyzed to determine the details of the burst. Only burst which match the supplied burst type and modulation are considered in results analysis. For IEEE 802.11b this command can only be queried as the decoding of the signal field is always performed for the IEEE 802.11b standard.

Parameters:

<State>

ON | OFF

Example:

DEM:FORM:SIGS ON

Specifies that the signal symbol field should be decoded.

Mode:

WLAN

Manual operation: See "Signal Field Content (IEEE 802.11a, g (OFDM), j & n (SISO), p)" on page 98
See "Use Header Content (IEEE 802.11b, g – Single Carrier)" on page 98

[SENSe:]DEMod:TXARea <State>

If enabled, the R&S FSV WLAN application initially performs a coarse burst search on the input signal in which increases in the power vs time trace are detected. Further time-consuming processing is then only performed where bursts are assumed. This improves the measurement speed for signals with low duty cycle rates.

However, for signals in which the PPDU power levels differ significantly, this option should be disabled as otherwise some PPDUs may not be detected.

Parameters:

<State> ON | OFF | 0 | 1
ON | 1
 A coarse burst search is performed based on the power levels of the input signal.
OFF | 0
 No pre-evaluation is performed, the entire signal is processed.
 *RST: 1

Manual operation: See "[Power Interval Search \(IEEE 802.11ac only\)](#)" on page 108

[SENSe:]FREQUENCY:CENTer <Frequency>

This command defines the center frequency (frequency domain) or measuring frequency (time domain).

Parameters:

<Frequency> Range: 0 to f_{max}
 *RST: f_{max}/2
 Default unit: Hz
 f_{max} is specified in the data sheet. min span is 10 Hz

Example: `FREQ:CENT 100 MHz`

Manual operation: See "[Frequency](#)" on page 88

[SENSe:]POWER:ACHannel:MODE <Mode>

This command sets the ACP measurement mode for the IEEE 802.11j standard to either absolute or relative.

Parameters:

<Mode> ABS | REL
ABS
 Absolute measurement
REL
 Relative measurement
 *RST: REL

Example: `POW:ACH:MODE ABS`
 Sets the ACP measurement to absolute mode

Mode: WLAN

[SENSe:]POWer:SEM:CLASs

This command sets the Spectrum Emission Mask (SEM) power class index. The index represents the power classes to be applied. The index is directly related to the entries displayed in the power class drop down combo box, within the SEM settings configuration page.

Parameters:

*RST: 0

Example:

POW:ACH:SEM:CLAS 0

Sets the SEM power class to automatic

Mode:

WLAN

[SENSe:]POWer:SEM <Type>

This command sets the Spectrum Emission Mask (SEM) measurement type. This is either IEEE, ETSI Spectrum mask or a user defined file.

Parameters:

<Type> IEEE | ETSI | User

User

Settings and limits are configured via a user-defined XML file. Load the file using [MMEMoRY:LOAD:SEM:STATe 1](#), on page 180.

IEEE

Settings and limits are as specified in the IEEE Std 802.11n™-2009 Figure 20-17—Transmit spectral mask for 20 MHz transmission. For other IEEE standards see the parameter values in the table below.

After a query, IEEE is returned for all IEEE standards.

ETSI

Settings and limits are as specified in the ETSI standard.

*RST: IEEE

Example:

POW:SEM ETSI

Sets the SEM ETSI measurement type

Mode:

WLAN

Manual operation: See "[SEM according to](#)" on page 81

Table 5-1: Supported IEEE standards

Manual operation	The spectrum emission mask measurement is performed according to the standard	Parameter value
IEEE 802.11n-2009 20M@2.4G	IEEE Std 802.11n™-2009 Figure 20-17—Transmit spectral mask for 20 MHz transmission	IEEE or 'IEEE_2009_20_2_4'
IEEE 802.11n-2009 40M@2.4G	IEEE Std 802.11n™-2009 Figure 20-18—Transmit spectral mask for a 40 MHz channel	'IEEE_2009_40_2_4'
IEEE 802.11n-2009 20M@5G	IEEE Std 802.11n™-2009 Figure 20-17—Transmit spectral mask for 20 MHz transmission	'IEEE_2009_20_5'
IEEE 802.11n-2009 40M@5G	IEEE Std 802.11n™-2009 Figure 20-18—Transmit spectral mask for a 40 MHz channel	'IEEE_2009_40_5'
IEEE 802.11mb/D08 20M@2.4G	IEEE Std 802.11n™-2009 Figure 20-17—Transmit spectral mask for 20 MHz transmission IEEE Draft P802.11-REVmb™/D8.0, March 2011 Figure 19-17—Transmit spectral mask for 20 MHz transmission in the 2.4 GHz band	'IEEE_D08_20_2_4'
IEEE 802.11mb/D08 40M@2.4G	IEEE Std 802.11n™-2009 Figure 20-18—Transmit spectral mask for a 40 MHz channel IEEE Draft P802.11-REVmb™/D8.0, March 2011 Figure 19-18—Transmit spectral mask for a 40 MHz channel in the 2.4 GHz band	'IEEE_D08_40_2_4'
IEEE 802.11mb/D08 20M@5G	IEEE Draft P802.11-REVmb™/D8.0, March 2011 Figure 19-19—Transmit spectral mask for 20 MHz transmission in the 5 GHz band	'IEEE_D08_20_5'
IEEE 802.11mb/D08 40M@5G	IEEE Draft P802.11-REVmb™/D8.0, March 2011 Figure 19-20—Transmit spectral mask for a 40 MHz channel in the 5 GHz band	'IEEE_D08_40_5'
IEEE 802.11ac/D1.1 20M@5G	IEEE P802.11ac™/D1.1, August 2011 Figure 22-17—Transmit spectral mask for a 20 MHz channel	'IEEE_AC_D1_1_20_5'
IEEE 802.11ac/D1.1 40M@5G	IEEE P802.11ac™/D1.1, August 2011 Figure 22-18—Transmit spectral mask for a 40 MHz channel	'IEEE_AC_D1_1_40_5'
IEEE 802.11ac/D1.1 80M@5G	IEEE P802.11ac™/D1.1, August 2011 Figure 22-19—Transmit spectral mask for a 80 MHz channel	'IEEE_AC_D1_1_80_5'

[SENSe:]POWER:SEM:TRACe:REDuction <Method>

This command specifies how trace reduction is performed for the Spectrum Emission Mask (SEM) measurement.

Parameters:

<Method>

PEAK

For each frequency range, the peak detector is used to determine the corresponding trace value. This was the behaviour for the SEM measurement in R&S FSV-K91 versions before 1.70.

DETECTOR

For each frequency range, the trace detector defined in the SEM xml file is used to determine the corresponding trace value.

*RST: PEAK

Example:

POW:SEM:TRAC:RED PEAK

Set SEM measurement to use peak trace reduction

Mode:

WLAN

Manual operation: See ["Trace Reduction"](#) on page 82**[SENSe:]SWAPiQ <State>**

This command defines whether or not the recorded IQ pairs should be swapped (I<->Q) before being processed. Swapping I and Q inverts the sideband.

Parameters:

<State>

ON | OFF

ON

I and Q are exchanged, inverted sideband, Q+j*I

OFF

Normal sideband, I+j*Q,

*RST: OFF

Example:

SWAP ON

Specifies that IQ values should be swapped.

Mode:

WLAN, GSM, OFDM, OFDMA/WiBro

Manual operation: See ["Swap IQ"](#) on page 92**[SENSe:]SWEep:COUNT <NumberSweeps>**

This command specifies the number of sweeps for Spectrum Mask and Spectrum ACPR measurements.

Parameters:

<NumberSweeps>

*RST: 1

Example:

SWEep:COUNT 64

Sets the number of sweeps to 64.

Usage: SCPI confirmed
Mode: WLAN
Manual operation: See "[Sweep Count](#)" on page 90

[SENSe:]SWEep:EGATe <State>

This command switches on/off the sweep control by an external gate signal. If the external gate is selected the trigger source is automatically switched to EXTERNAL as well.

In case of measurement with external gate, the measured values are recorded as long as the gate is opened. During a sweep the gate can be opened and closed several times. The synchronization mechanisms with *OPC, *OPC? and *WAI remain completely unaffected.

The sweep end is detected when the required number of measurement points (691 in "Spectrum" mode) has been recorded.

Parameters:

<State> ON | OFF
 *RST: OFF

Example:

```
SWE:EGAT ON
Switches on the external gate mode.
SWE:EGAT:TYPE EDGE
Switches on the edge-triggered mode.
SWE:EGAT:HOLD 100US
Sets the gate delay to 100 µs.
SWE:EGAT:LEN 500US
Sets the gate opening time to 500 µs.
INIT;*WAI
Starts a sweep and waits for its end.
```

[SENSe:]SWEep:EGATe:HOLDoff[:TIME] <Time>

This command defines the gate delay in the capture buffer in time units. The range of this value is dependent on the last run measurement.

Parameters:

<Time> *RST: 100µs

Example:

```
SWE:EGAT:HOLD 125us
Sets a delay of 125µs in the capture buffer.
```

Mode: WLAN

[SENSe:]SWEep:EGATe:HOLDoff:SAMPle <NumberSamples>

This command defines the gate delay in the capture buffer as a number of samples. The range of this value is dependent on the last run measurement.

Parameters:

<NumberSamples> *RST: 2000

Example:

SWE:EGAT:HOLD:SAMP 2500

Sets a delay of 2500 samples in the capture buffer.

Mode:

WLAN

[SENSe:]SWEep:EGATe:LENGth[:TIME] <Time>

This command defines the gate time in the capture buffer in time units. The range of this value is dependent on the last run measurement.

Parameters:

<Time> *RST: 400µs

Example:

SWE:EGAT:LENG 20ms

Sets a gate length of 20 milliseconds between sweeps.

Mode:

WLAN

[SENSe:]SWEep:EGATe:LENGth:SAMPle <NumberSamples>

This command defines the gate time in the capture buffer as a number of samples. The range of this value is dependent on the last run measurement.

Parameters:

<NumberSamples> *RST: 8000

Example:

SWE:EGAT:LENG:SAMP 200000

Sets a gate length of 200000 samples in the capture buffer.

Mode:

WLAN

[SENSe:]SWEep:EGATe:LINK <State>

This command links together the movement of the gating lines and the capture buffer marker.

Parameters:

<State> ON | OFF

*RST: 0

Example:

SWE:EGAT:LINK ON

Links the gating lines as marker with the gating line delay and length are changed gate position.

Mode:

WLAN

Manual operation:

See "[Gating Settings On/Off \(\(IEEE 802.11a, b, g, j, p\)\)](#)" on page 67

[SENSe:]SWEep:TIME <Time>

This command defines the sweep time.

The range depends on the frequency span.

Parameters:

<Time> refer to data sheet
*RST: (automatic)

Example: SWE:TIME 10s

Manual operation: See "[Capture Time](#)" on page 89

[SENSe:]SWEep:EGATe:TYPE <Mode>

This command sets the type of triggering (level or edge) by the external gate signal.

The gate opening time cannot be defined with the command [\[SENSe:\]SWEep:EGATe:LENGth\[:TIME\]](#) if level triggering is used. The gate is closed when the gate signal disappears.

Parameters:

<Mode> LEVEL | EDGE
*RST: EDGE

Example: SWE:EGAT:TYPE EDGE
Sets the gate mode to EDGE.

Mode: WLAN

[SENSe:]TRACking:LEVel <State>

This command defines whether or not the measurement results should be compensated for level.

Parameters:

<State> ON | OFF
*RST: OFF

Example: TRAC:LEV ON
Specifies that the measurement results should be compensated for level.

Mode: WLAN

Manual operation: See "[Level](#)" on page 103

[SENSe:]TRACking:PHASe <State>

This command defines whether or not the measurement results should be compensated for phase.

Parameters:

<State> ON | OFF
 *RST: ON

Example:

TRAC:PHAS ON

Specifies that the measurement results should be compensated for phase.

Mode: WLAN

Manual operation: See "Phase" on page 102

[SENSe:]TRACking:PILOts <Mode>

This command configures how the pilots of the signal is determined.

Parameters:

<Mode> **STANdard**
 The pilot of the signal is determined as defined by the standard.
DETEcted
 The pilot is detected by estimation; useful when the signal deviates from the standard
 *RST: STANdard

Mode: WLAN (IEEE 802.11ac/n (MIMO))

Manual operation: See "Pilots for Tracking (IEEE 802.11n, ac (SISO+MIMO))" on page 103

[SENSe:]TRACking:TIME <State>

This command defines whether or not the measurement results should be compensated for time.

Parameters:

<State> ON | OFF

Mode: WLAN

Manual operation: See "Timing" on page 102

5.15 STATus Subsystem (WLAN)

The following commands can be used to query the contents of the status registers specific to the R&S FSV-K91 option. For details see [chapter 5.19, "Status Reporting System \(Option R&S FSV-K91\)"](#), on page 221.

For details on general status register commands, see the base unit description.

STATus:OPERation:CONDition	205
STATus:OPERation[:EVENT]	205
STATus:QUESTionable:CONDition	205

STATus:QUEStionable[:EVENT]?	206
STATus:QUEStionable:ACPLimit[:EVENT]	206
STATus:QUEStionable:LIMit<Screen>[:EVENT]	206
STATus:QUEStionable:SYNC[:EVENT]?	206
STATus:QUEStionable:ACPLimit:CONDition	206
STATus:QUEStionable:LIMit<Screen>:CONDition	206
STATus:QUEStionable:SYNC:CONDition?	206
STATus:QUEStionable:ACPLimit:ENABle	207
STATus:QUEStionable:LIMit<Screen>:ENABle	207
STATus:QUEStionable:SYNC:ENABle?	207
STATus:QUEStionable:ACPLimit:NTRansition	207
STATus:QUEStionable:LIMit<Screen>:NTRansition	207
STATus:QUEStionable:SYNC:NTRansition?	207
STATus:QUEStionable:ACPLimit:PTRansition	208
STATus:QUEStionable:LIMit<Screen>:PTRansition	208
STATus:QUEStionable:SYNC:PTRansition?	208

STATus:OPERation:CONDition

This command queries the CONDition part of the STATus:OPERation register (see the base unit description of status registers in the Remote Control Basics chapter).

Readout does not delete the contents of the CONDition part. The value returned reflects the current hardware status.

Example: STAT:OPER:COND?

Mode: all

STATus:OPERation[:EVENT]

This command queries the contents of the EVENT part of the STATus:OPERation register. The contents of the EVENT part are deleted after readout.

Example: STAT:OPER?

Mode: all

STATus:QUEStionable:CONDition

This command queries the CONDition part of the "STATus:QUEStionable" register. This part contains the sum bit of the next lower register. This register part can only be read, but not written into or cleared. Readout does not delete the contents of the CONDition part.

Example: STAT:QUES:COND?

Mode: all

STATus:QUEStionable[:EVENT]?

This command queries the contents of the EVENT part of the STATus:QUEStionable register. The EVENT part indicates whether an event has occurred since the last reading, it is the "memory" of the condition part. It only indicates events passed on by the transition filters. It is permanently updated by the instrument. This part can only be read by the user. Reading the register clears it.

Example: STAT:QUES?

Usage: Query only

Mode: all

STATus:QUEStionable:ACPLimit[:EVENT]**STATus:QUEStionable:LIMit<Screen>[:EVENT]****STATus:QUEStionable:SYNC[:EVENT]?**

The EVENT part indicates whether an event has occurred since the last reading. It only indicates events passed on by the transition filters. It is permanently updated by the instrument. This part can only be read by the user. Reading the register clears it.

Possible events are described in:

[chapter 5.19.5, "STATus:QUEStionable:ACPLimit Register"](#), on page 227

[chapter 5.19.3, "STATus:QUEStionable:LIMit Register"](#), on page 225

[chapter 5.19.4, "STATus:QUEStionable:SYNC Register"](#), on page 226

Suffix:

<Screen> 1 | 2

1 = Screen A, 2 = Screen B

Note that limit lines are not displayed in screen A, thus

STAT:QUES:LIM1? always returns 0.

Usage: Query only
SCPI confirmed

Mode: WLAN

STATus:QUEStionable:ACPLimit:CONDition**STATus:QUEStionable:LIMit<Screen>:CONDition****STATus:QUEStionable:SYNC:CONDition?**

Contains the current status of the instrument. This register part can only be read, but not written into or cleared. Readout does not delete the contents of the CONDition section.

Suffix:

<Screen> 1 | 2

1 = Screen A, 2 = Screen B

Note that limit lines are not displayed in screen A, thus

STAT:QUES:LIM1:COND? always returns 0.

Usage: Query only
SCPI confirmed

Mode: WLAN

STATus:QUESTionable:ACPLimit:ENABLE
STATus:QUESTionable:LIMit<Screen>:ENABLE
STATus:QUESTionable:SYNC:ENABLE? <Filter>

Determines whether the `EVENTt` bit of the associated status register contributes to the sum bit of the `STATus:QUESTionable` register. Each bit of the `EVENT` part is "ANDed" with the associated `ENABLE` bit. The results of all logical operations of this part are passed on to the event sum bit via an "OR" function.

Suffix:
 <Screen> 1 | 2
 1 = Screen A, 2 = Screen B
 Note that limit lines are not displayed in screen A, thus
`STAT:QUES:LIM1:ENAB` is irrelevant.

Parameters:
 <Filter> The sum of the decimal values of the event bits that are to be enabled for the summmary bit.
 Range: 0 to 65535

Usage: Query only
SCPI confirmed

Mode: WLAN

STATus:QUESTionable:ACPLimit:NTRansition
STATus:QUESTionable:LIMit<Screen>:NTRansition
STATus:QUESTionable:SYNC:NTRansition? <Filter>

This bit acts as a transition filter. When a bit of the `CONDition` part of the associated status register for the result type is changed from 1 to 0, the `NTR` bit decides whether the `EVENTt` bit is set to 1.

Suffix:
 <Screen> 1 | 2
 1 = Screen A, 2 = Screen B
 Note that limit lines are not displayed in screen A, thus
`STAT:QUES:LIM1:NTR` is irrelevant.

Parameters:
 <Filter> The sum of the decimal values of the event bits that are to be enabled.
 Range: 0 to 65535

Example: `STAT:QUES:LIM:NTR 65535`
 All condition bits will be summarized in the Event register when a negative transition occurs.

Usage: Query only
SCPI confirmed

Mode: WLAN

STATus:QUESTionable:ACPLimit:PTRansition
STATus:QUESTionable:LIMit<Screen>:PTRansition
STATus:QUESTionable:SYNC:PTRansition? <Filter>

This bit acts as a transition filter. When a bit of the `CONDition` part of the associated status register for the result type is changed from 0 to 1, the `PTR` bit decides whether the `EVENT` bit is set to 1.

Suffix:
 <Screen> 1 | 2
 1 = Screen A, 2 = Screen B
 Note that limit lines are not displayed in screen A, thus
`STAT:QUES:LIM1:PTR` is irrelevant.

Parameters:
 <Filter> The sum of the decimal values of the event bits that are to be enabled.
 Range: 0 to 65535

Example: `STAT:QUES:LIM:PTR 65535`
 All condition bits will be summarized in the Event register when a positive transition occurs.

Usage: Query only
SCPI confirmed

Mode: WLAN

5.16 TRACe Subsystem (WLAN)

The TRACe subsystem controls access to the instrument's internal trace memory.

5.16.1	Commands of the TRACe Subsystem.....	209
5.16.2	I/Q Measurements.....	211
5.16.2.1	Constellation vs Symbol.....	211
5.16.2.2	Constellation vs Carrier.....	211
5.16.3	Power vs Time – Full Burst and Rising/Falling Data.....	212
5.16.4	Spectrum Flatness.....	212
5.16.5	Spectrum Flatness 11n.....	213
5.16.6	Spectrum Group Delay 11n.....	213
5.16.7	Spectrum FFT.....	214

5.16.8	Statistics Bitstream Data.....	214
5.16.9	Statistics CCDF – Complementary Cumulative Distribution Function.....	214
5.16.10	Statistics Signal Field Data.....	215
5.16.11	EVM vs Carrier.....	215
5.16.12	EVM vs Symbol.....	215
5.16.13	Error vs Preamble.....	216
5.16.14	Frequency Sweep Measurements.....	216
5.16.14.1	Spectrum Mask.....	216
5.16.15	Spectrum ACPR.....	216

5.16.1 Commands of the TRACe Subsystem

TRACe[:DATA]?	209
TRACe:IQ:SRATe	210
TRACe:IQ:DATA:MEMory ?	210

TRACe[:DATA]? <ResultType>

This command returns all the measured data that relates to the currently selected measurement type. All results are returned in ASCII format. The returned data depends on the currently selected measurement type.

The following measurement types are available:

- [chapter 5.16.2.1, "Constellation vs Symbol"](#), on page 211
- [chapter 5.16.2.2, "Constellation vs Carrier"](#), on page 211
- [chapter 5.16.3, "Power vs Time – Full Burst and Rising/Falling Data"](#), on page 212
- [chapter 5.16.4, "Spectrum Flatness"](#), on page 212
- [chapter 5.16.7, "Spectrum FFT"](#), on page 214
- [chapter 5.16.8, "Statistics Bitstream Data"](#), on page 214
- [chapter 5.16.9, "Statistics CCDF – Complementary Cumulative Distribution Function"](#), on page 214
- [chapter 5.16.10, "Statistics Signal Field Data"](#), on page 215
- [chapter 5.16.11, "EVM vs Carrier"](#), on page 215
- [chapter 5.16.12, "EVM vs Symbol"](#), on page 215
- [chapter 5.16.13, "Error vs Preamble"](#), on page 216
- [chapter 5.16.14.1, "Spectrum Mask"](#), on page 216
- [chapter 5.16.15, "Spectrum ACPR"](#), on page 216

Query parameters:

<ResultType> TRACE1 | TRACE2 | TRACE3 | TRACE4 | TRACE5 | TRACE6 | LIST

For details on the parameters refer to the corresponding measurement type (see list above).

Example:

TRAC? TRACE2

The measurement data for the selected graph is returned.

Usage:

Query only
SCPI confirmed

Mode:

WLAN

TRACe:IQ:SRATe <SampleRate>

This command allows the sample rate for IQ measurements to be specified.

Parameters:

<SampleRate> Range: 1440000 to 32.248E6 Hz

Example:

TRAC:IQ:SRAT 2000000

Specifies a sample rate of 20 MHz.

Mode:

WLAN

Manual operation: See "[Sample Rate](#)" on page 93

TRACe:IQ:DATA:MEMory ? <OffsetSa>, <NoSamples>

Returns all the I/Q data associated with the measurement acquisition time. The result values are scaled linearly in Volts and correspond to the voltage at the RF input of the instrument. The command returns a comma-separated list of the measured voltage values in floating point format (Comma Separated Values = CSV). The number of values returned is 2 * the number of samples, the first half being the I values, the second half the Q values.

Query parameters:

<OffsetSa> Offset of the values to be read related to the start of the acquired data.

Range: 0 to <NoSamples>

*RST: RST value

<NoSamples> Number of measurement values to be read.

Range: 1 to (<NoSamples>-<OffsetSa>)

*RST: RST value

Example:

TRAC:IQ:DATA:MEM? 0,2000

Requests first 2000 samples.

Usage:

Query only

Mode:

WLAN

5.16.2 I/Q Measurements

There are a number of measurements that can be performed in I/Q mode. No data is returned for any of the following measurements, should it be requested, until a measurement belonging to the I/Q group has been run. Running a frequency sweep measurement, for example Spectrum Mask, does not generate results for this measurement group.

5.16.2.1 Constellation vs Symbol

This measurement represents I and Q data. Each I and Q point is returned in floating point format. TRACE1 is used for these measurement results.

For the IEEE 802.11a, j and n standard, data is returned as a repeating array of interleaved I and Q data in groups of selected carriers, until all the data is exhausted. The following rules apply:

- If "All Carriers" is selected, 52 pairs of I and Q data per symbol are returned.
- If "Pilots Only" is selected, 4 pairs of I and Q data per symbol are returned in the following order: Carrier -21, Carrier -7, Carrier 7, Carrier 21.
- If a single carrier is selected, 1 pair of I and Q data per symbol is returned.

For IEEE 802.11n only:

- 20 MHz Channel Bandwidth.
If "All Carriers" is selected, it will return 56 pairs of I and Q data per symbol. If "Pilots Only" is selected, it will return 4 pairs of I and Q per symbol in the following order: Carrier -21, Carrier -7, Carrier 7, Carrier 21. If a single carrier is selected, it will return 1 pair of I and Q data per symbol.
- 40 MHz Channel Bandwidth
If "All Carriers" is selected, it will return 116 pairs of I and Q data per symbol. If "Pilots Only" is selected, it will return 6 pairs of I and Q per symbol in the following order: Carrier -53, Carrier -25, Carrier -11, Carrier 11, Carrier 25, Carrier 53. If a single carrier is selected, it will return 1 pair of I and Q data per symbol.

For IEEE 802.11b, the data is returned as a repeating array of interleaved I and Q data in symbol order until all the data is exhausted.

5.16.2.2 Constellation vs Carrier

This measurement represents I and Q data. Data is returned as a repeating array of interleaved I and Q data in groups of 53 channels (57 within the n standard) including DC, until all the data is exhausted. The IEEE 80211n Standard has 57 carrier for 20MHz channel bandwidth including DC and 117 carriers for 40MHz channel bandwidth including 3 DC.

Each I and Q point is returned in floating point format. TRACE1 is used for these measurement results.

Supported data formats (see [FORMat \[:DATA\]](#) on page 176): ASCii|REAL

5.16.3 Power vs Time – Full Burst and Rising/Falling Data

Both measurement results are again simply slightly different views of the same results data.

All complete bursts within the capture time are analyzed in three master bursts. The three master bursts relate to the minimum, maximum and average values across all complete bursts. This data is returned in dBm values on a per sample basis. Each sample relates to an analysis of each corresponding sample within each processed burst.

The type of PVT data returned is determined by the TRACE number passed as an argument to the SCPI command, in addition to the graphic type that is selected.

If the graphic type selected is "Full burst", then the return data is as follows.

TRACE1	full burst, minimum burst data values
TRACE2	full burst, mean burst data values
TRACE3	full burst, maximum burst data values

If the graphic type selected is "EDGE", then the return data is as follows.

TRACE1	rising edge, minimum burst data values
TRACE2	rising edge, mean burst data values
TRACE3	rising edge, maximum burst data values
TRACE4	falling edge, minimum burst data values
TRACE5	falling edge, mean burst data values
TRACE6	falling edge, maximum burst data values

Supported data formats (see [FORMat\[:DATA\]](#) on page 176): ASCii|REAL

For IEEE 802.11b:

If the graphic type selected is "RISing" or "FALLing", only 3 traces are available (1 to 3) and represent the minimum, mean and maximum bursts data for the respective graph selection. The number of samples returned during full burst analysis depends on the modulation type and is typically 5000.

The number of samples returned when the "Rising and falling" graphic type is selected is less than what is returned for full burst and is approximately 400 samples. The samples are returned in floating point format as a single sequence of comma delimited values.

5.16.4 Spectrum Flatness

Four separate traces are available for these measurements. Trace data for a particular trace is only obtainable by querying the appropriate trace.

Spectrum flatness provides two basic graph types: an absolute power value graph (ABS) and a relative group delay graph. Both are plotted on a per carrier basis. All 52 carriers are drawn, in addition to the unused 0 carrier. Both the absolute power and group delay graph groups allow all the data points to be returned as one trace and an average of all the channels as the other trace.

For example, the return data is either one single group of 53 carriers (or 57 within the n standard) if the average trace is selected, or a repeating group of 53 (or 57 within the n standard) carriers if all the data is requested.

Supported data formats (see [FORMat \[:DATA\]](#) on page 176): ASCii|REAL

TRACE1	ABS	All analyzed traces
TRACE2	Group Delay	All analyzed traces
TRACE3	ABS	Average trace
TRACE4	Group Delay	Average trace

Absolute power results are returned in dB or dB difference and group delay results are returned in ns.

5.16.5 Spectrum Flatness 11n

There are two separate traces that are available with this measurement. Trace data for a particular trace will only be returnable by querying the appropriate trace. The graph shows the absolute power value graph (ABS), which is plotted on a per carrier basis. All 56 carriers are drawn, in addition to the unused 0 carrier. The absolute power groups will allow all the data points to be returned as one trace and an average of all the channels as the other trace. For example, the return data will either be one single group of 57 carriers if the average trace is selected or a repeating group of 57 carriers if all the data is requested.

TRACE1	ABS	All analyzed trains
TRACE2	ABS	Average trace

Absolute power results are returned in dB.

Supported data formats (FORMat:DATA): ASCii|REAL

5.16.6 Spectrum Group Delay 11n

There are two separate traces that are available with this measurement. Trace data for a particular trace will only be returnable by querying the appropriate trace. The graph shows the relative group delay graph, which is plotted on a per carrier basis. All 56 carriers are drawn, in addition to the unused 0 carrier. The group delay graph groups will allow all the data points to be returned as one trace and an average of all the channels as the other trace. For example, the return data will either be one single group of 57

carriers if the average trace is selected or a repeating group of 57 carriers if all the data is requested.

TRACE1	Group Delay	All analyzed trains
TRACE2	Group Delay	Average trace

Group delay results are returned in ns.

Supported data formats (FORMat:DATA): ASCii|REAL

5.16.7 Spectrum FFT

All FFT points are returned if the data for this measurement is requested. This is an exhaustive call, due to the fact that there are nearly always more FFT points than IQ samples. The number of FFT points is the number presented by a power of 2 that is higher than the total number of samples.

E.g. if there were 20000 samples, then 32768 FFT points would be returned.

Data is returned in floating point format in dBm. TRACE1 is used for these measurement results.

5.16.8 Statistics Bitstream Data

Data is returned depending on the selected standard from which the measurement was executed:

- For the IEEE 802.11a,j & n standard, data is returned in repeating groups of 52 data channels (or 56 channels within the n standard) where each symbol value is represented by an integer value within one byte. Channel 0 is unused and therefore does not have any data associated with it, with no return data being provided.
- For the IEEE 802.11b standard, the data is returned in burst order. Each burst is represented as a series of bytes. For each burst, the first 9 or 18 bytes represent the PLCP preamble for short and long burst types, respectively. The next 6 bytes represent the PLCP header. The remaining bytes represent the PSDU. Data is returned in ASCII printable hexadecimal character format. TRACE1 is used for these measurement results.

Supported data formats (see FORMat [:DATA] on page 176): ASCii|UINT

5.16.9 Statistics CCDF – Complementary Cumulative Distribution Function

Up to a maximum of 201 data points is returned in addition to a data count value. The first value in the return data represents the quantity of probability values that follow. Each of the potential 201 data points is returned as probability value and represents the total number of samples that are equal to or exceed the corresponding power level.

Probability data is returned up to the power level that contains at least one sample. It is highly unlikely that the full 201 data values will ever be returned.

Each probability value is returned as a floating point number, with a value less than 1.

Supported data formats (see [FORMat \[:DATA\]](#) on page 176): ASCii|REAL

5.16.10 Statistics Signal Field Data

Data is returned as an array of hexadecimal values, with each hexadecimal value representing the 24 bit (IEEE 802.11b standard: 48 bit) long signal field for a single burst.

5.16.11 EVM vs Carrier

Two trace types are provided with this measurement. There is an average EVM value for each of the 53 (or 57/117 within the standard) carriers or a repeating group of EVM values for each channel. The number of repeating groups corresponds to the number of fully analyzed trains.

Each EVM value is returned as a floating point number, expressed in units of dBm.

Supported data formats (see [FORMat \[:DATA\]](#) on page 176): ASCii|UINT

TRACE1	Average EVM values per channel
TRACE2	All EVM values per channel for each full train of the capture period

5.16.12 EVM vs Symbol

Three traces types are available with this measurement. The basic trace types show either the minimum, mean or maximum EVM value, as measured over the complete capture period.

The number of repeating groups that are returned is equal to the number of measured symbols.

Each EVM value is returned as a floating point number, expressed in units of dBm.

Supported data formats (see [FORMat \[:DATA\]](#) on page 176): ASCii|REAL

Table 5-2: IEEE 802.11a, j & n

TRACE1	Minimum EVM values
TRACE2	Mean EVM values
TRACE3	Maximum EVM values

Table 5-3: IEEE 802.11b

TRACE1	EVM IEEE values
TRACE2	EVM Direct values

5.16.13 Error vs Preamble

Three traces types are available with this measurement. The basic trace types show either the minimum, mean or maximum frequency or phase value as measured over the preamble part of the burst.

Supported data formats (see [FORMat \[:DATA\]](#) on page 176): ASCii|REAL

5.16.14 Frequency Sweep Measurements

Currently, there is only one measurement that is performed in frequency sweep mode. This is the Spectrum Mask measurement. No data is returned for this measurement, should it be requested, until such a measurement has been previously run.

Running an IQ measurement does not generate results for this type of measurement.

5.16.14.1 Spectrum Mask

Result data is returned as 625 trace points in floating point format. These trace points are obtained directly from the base system via the measurement API and the quantity is therefore a fixed value. Only an array of Y data is returned.

Supported data formats (see [FORMat \[:DATA\]](#) on page 176): ASCii|REAL

TRACE1	Clear write values
TRACE2	Max hold values
LIST	Spectrum Emission Mask (SEM) summary results

Table 5-4: SEM summary results formats:

1st value	Index into table of results (1 – 50)
2nd value	Start frequency band (Hz)
3rd value	Stop frequency band (Hz)
4th value	RBW (Hz)
5th value	Limit fail frequency (Hz)
6th value	Power absolute (dBm)
7th value	Power relative (dBc)
8th value	Limit distance (dB)
9th value	Failure flag (1 = fail, 0 = pass)

5.16.15 Spectrum ACPR

Result data is returned as 625 trace points in floating point format. These trace points are obtained directly from the base system via the measurement API and the quantity

is therefore a fixed value. Only an array of Y data is returned. TRACE1 is used for these measurement results.

Supported data formats (see [FORMat \[:DATA\]](#) on page 176): ASCii|REAL

TRACE1	Clear write values
TRACE2	Max hold values

5.17 TRIGger Subsystem (WLAN)

The trigger subsystem is used to synchronize device action(s) with events.

TRIGger[:SEQuence]:HOLDoff.....	217
TRIGger<n>[:SEQuence]:IFPower:HOLDoff.....	217
TRIGger<n>[:SEQuence]:IFPower:HYSTeresis.....	218
TRIGger<n>[:SEQuence]:LEVel[:EXTeRnal].....	218
TRIGger[:SEQuence]:MODE.....	218
TRIGger[:SEQuence]:LEVel:POWer.....	219
TRIGger[:SEQuence]:LEVel:POWer:AUTO.....	220

TRIGger[:SEQuence]:HOLDoff <Delay>

This command defines the length of the trigger delay. A negative delay time (pretrigger) can be set in zero span only.

Parameters:

<Delay> Range: -3.25 to 837.33
 *RST: 0 s
 Default unit: ms

Example:

TRIG:HOLD 500us

A holdoff period of 500 µs is used after the trigger condition has been met.

Usage: SCPI confirmed

Mode: WLAN

Manual operation: See "[Trigger Offset](#)" on page 90

TRIGger<n>[:SEQuence]:IFPower:HOLDoff <Value>

This command sets the holding time before the next IF power trigger event.

Suffix:

<n> irrelevant

Parameters:

<Value> *RST: 150 ns

Example: TRIG:SOUR IFP
Sets the IF power trigger source.
TRIG:IFP:HOLD 200 ns
Sets the holding time to 200 ns.

Manual operation: See ["Trigger Holdoff"](#) on page 90

TRIGger<n>[:SEQUENCE]:IFPower:HYSteresis <Value>

This command sets the limit that the hysteresis value for the IF power trigger has to fall below in order to trigger the next measurement.

Suffix:
<n> irrelevant

Parameters:
<Value> *RST: 3 dB

Example: TRIG:SOUR IFP
Sets the IF power trigger source.
TRIG:IFP:HYST 10DB
Sets the hysteresis limit value.

Manual operation: See ["Trigger Hysteresis"](#) on page 91

TRIGger<n>[:SEQUENCE]:LEVel[:EXTernal] <TriggerLevel>

This command sets the level of the external trigger source in Volt.

Suffix:
<n> irrelevant

Parameters:
<TriggerLevel> Range: 0.5 V to 3.5 V
 *RST: 1.4 V

Example: TRIG:LEV 2V

Manual operation: See ["Ext. Trigger Lvl"](#) on page 91

TRIGger[:SEQUENCE]:MODE <Mode>

This command configures how triggering is to be performed.

Parameters:

<Mode>

IMMediate | EXTernal | POWer | PSEnSor | RFPower

IMMediate

No triggering is performed. This corresponds to the Free Run trigger mode.

EXTernal

The next measurement is triggered by the signal at the external trigger input e.g. a gated trigger.

POWer

The next measurement is triggered by signals outside the measurement channel.

PSEn

The next measurement is triggered by the external power sensor (requires R&S FSV-K9 option).

RFPower

The next measurement is triggered by the first intermediate frequency of the RF signal.

TUNit

If activated, the next measurement is triggered by the signal at the external trigger input connected to the R&S®FS-Z11 trigger unit. This allows for all connected analyzers to be synchronized for MIMO measurements.

For details see [chapter 3.6.1, "Trigger Synchronization Using an R&S®FS-Z11 Trigger Unit"](#), on page 37.

*RST: IMMEDIATE

Example:

```
TRIG:MODE IMM
```

No triggering is performed.

Mode:

WLAN

Manual operation: See ["Trigger Mode "](#) on page 90

TRIGger[:SEQuence]:LEVel:POWer <Level>

This command sets the level of the input signal for which triggering will occur.

Parameters:

<Level>

Range: -50 to 20

*RST: -20 DBM

Default unit: dBm

Example:

```
TRIG:MODE POW
```

Sets the external trigger mode.

```
TRIG:LEV:POW 10 DBM
```

Sets the level to 10 dBm for RF measurement.

Mode:

WLAN

Manual operation: See ["Power Level "](#) on page 91

TRIGger[:SEquence]:LEVel:POWer:AUTO <State>

This command specifies whether or not an automatic power trigger level calculation is performed before each main measurement. The setting of this command is ignored if the setting for the `TRIGger[:SEquence]:MODE` on page 218 command is not `POWER`.

Parameters:

<State> ON | OFF
 *RST: OFF

Example:

TRIG:LEV:POW:AUTO ON

Specifies that an automatic power trigger level calculation should be performed before the start of each main measurement.

Mode: WLAN

Manual operation: See "Auto Lvl " on page 91

5.18 UNIT Subsystem (K91)

<code>UNIT:EVM</code>	220
<code>UNIT:GIMBalance</code>	220
<code>UNIT:PREamble</code>	221

UNIT:EVM <Unit>

This command specifies the units for EVM results.

Parameters:

<Unit> DB | PCT
DB
 EVM results returned in dB
PCT
 EVM results returned in %
 *RST: DB

Example:

UNIT:EVM PCT

EVM results to be returned in %.

Mode: WLAN

UNIT:GIMBalance <Unit>

This command specifies the units for gain imbalance results.

Parameters:

<Unit> DB | PCT
DB
 Gain imbalance results returned in dB
PCT
 Gain imbalance results returned in %
 *RST: DB

Example:

UNIT:EVM PCT
 Gain imbalance results to be returned in %.

Mode:

WLAN

UNIT:PREamble <Unit>

This command specifies the units for preamble error results.

Parameters:

<Unit> HZ | PCT
HZ
 Preamble error results returned in HZ
PCT
 Preamble error results returned in %
 *RST: HZ

Example:

UNIT:EVM PCT
 Preamble error results to be returned in %.

Mode:

WLAN

5.19 Status Reporting System (Option R&S FSV-K91)

The status reporting system stores all information on the current operating state of the instrument, e.g. information on errors or limit violations which have occurred. This information is stored in the status registers and in the error queue. The status registers and the error queue can be queried via IEC bus.

In this section, only the new and altered status registers/bits for the WLAN option (R&S FSV-K91) are described. Detailed information on the status registers of the base system is given in the section "Status Reporting System" in chapter 5 of the Operating Manual on CD. A description of the remote commands required to query them is provided in "Remote Control – Description of Analyzer Commands" >"STATus:QUESTIONable Subsystem" in the base unit documentation.

Description of the Status Registers

The WLAN option (R&S FSV-K91) uses only status registers provided by the base unit. However, some registers are used differently, as described in the following sections.

The commands to query the contents of the following status registers are described in [chapter 5.15, "STATus Subsystem \(WLAN\)"](#), on page 204.

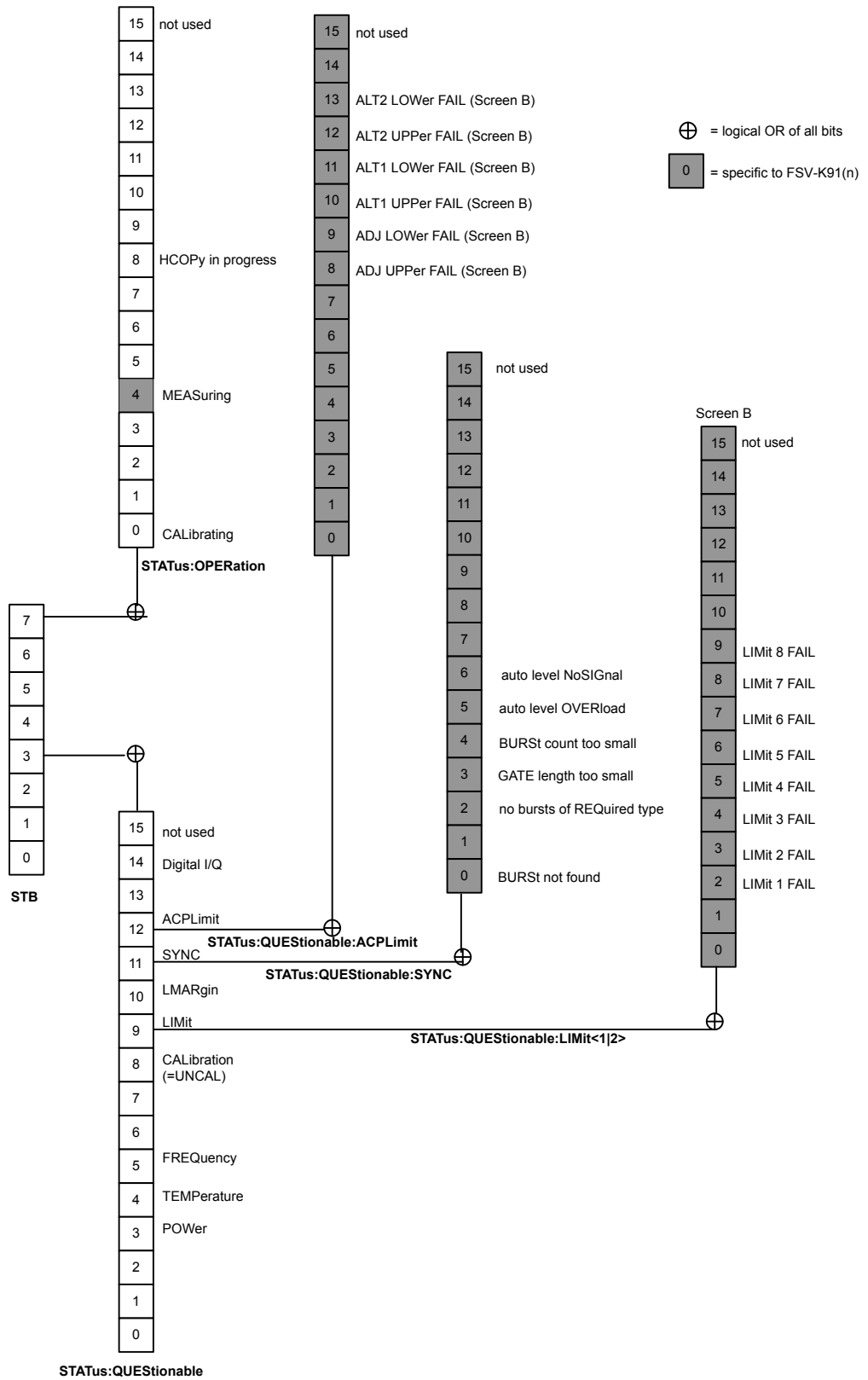

Fig. 5-1: Overview of WLAN-specific status registers

5.19.1	STATus:OPERation Register.....	224
5.19.2	STATus:QUEStionable Register.....	224
5.19.3	STATus:QUEStionable:LIMit Register.....	225
5.19.4	STATus:QUEStionable:SYNC Register.....	226
5.19.5	STATus:QUEStionable:ACPLimit Register.....	227

5.19.1 STATus:OPERation Register

This register contains information on which actions the instrument is executing or which actions the instrument has executed since the last reading. It can be read using the commands `STATus:OPERation:CONDition` or `STATus:OPERation[:EVENT]`.

Table 5-5: Meaning of the bits used in the STATus:OPERation register

Bit No.	Meaning
0	<code>CALibrating</code> This bit is set as long as the instrument is performing a calibration.
1 - 3	Not used
4	<code>MEASuring</code> This bit is set when a measurement is in progress (application-specific).
5 - 7	Not used
8	<code>HardCOpy</code> in progress This bit is set while the instrument is printing a hardcopy.
9 - 14	Not used
15	This bit is always 0.

5.19.2 STATus:QUEStionable Register

This register contains information about indefinite states which may occur if the unit is operated without meeting the specifications. It can be read using the commands `STATus:QUEStionable:CONDition` or `STATus:QUEStionable[:EVENT]?`.

Table 5-6: Meaning of the bits used in the STATus:QUEStionable register

Bit No.	Meaning
0 to 2	These bits are not used
3	<code>POWer</code> This bit is set if a questionable power occurs (see <code>STATus:QUEStionable:POWer</code> register in the base unit description).
4	<code>TEMPerature</code> This bit is set if a questionable temperature occurs.

Bit No.	Meaning
5	FREQUENCY The bit is set if a frequency is questionable (see <code>STATUS:QUESTIONABLE:FREQUENCY</code> register in the base unit description). Not available from the R&S FSV-K91 option.
6 to 7	Not used
8	CALIBRATION The bit is set if a measurement is performed unaligned ("UNCAL" display)
9	LIMIT (device-specific) This bit is set if a limit value is violated (see chapter 5.19.3, "STATUS:QUESTIONABLE:LIMIT Register" , on page 225). Note: The <code>Limit</code> register is associated with limit lines for the Spectrum Mask measurement only.
10	LMARGIN (device-specific) This bit is set if a margin is violated (see <code>STATUS:QUESTIONABLE:LMARGIN</code> register in the base unit description). Not available from the R&S FSV-K91 option.
11	SYNC (device-specific) This bit is set if, in measurements or pre-measurements in WLAN mode, synchronization fails, no signal is detected or no burst is found. This bit is also set if input settings conflict with the measurement setup (see chapter 5.19.4, "STATUS:QUESTIONABLE:SYNC Register" , on page 226).
12	ACPLIMIT (device-specific) This bit is set if a limit for the adjacent channel power measurement is violated (see chapter 5.19.5, "STATUS:QUESTIONABLE:ACPLIMIT Register" , on page 227)
13	Not used
15	This bit is always 0.

5.19.3 STATUS:QUESTIONABLE:LIMIT Register

This register contains information about the observance of limit lines. It can be read using the commands `STATUS:QUESTIONABLE:LIMIT2:CONDITION?` and `STATUS:QUESTIONABLE:LIMIT2[:EVENT]?`.



The `Limit` register is associated with limit lines for the Spectrum Mask measurement only. No limit lines are displayed in screen A and as such all bits in the `LIMIT1` register will always be set to 0.

Table 5-7: Meaning of the bits used in the STATUS:QUESTIONABLE:LIMIT2 register

Bit No	Meaning
0 to 1	These bits are not used
2	LIMIT FAIL This bit is set if the ETSI Spectrum Mask limit line is violated.

Bit No	Meaning
3	LIMit FAIL This bit is set if the Spectrum Flatness (Upper) limit line is violated.
4	LIMit FAIL This bit is set if the Spectrum Flatness (Lower) limit line is violated.
5	LIMit FAIL This bit is set if the IEEE Spectrum Mask limit line is violated.
6	LIMit FAIL This bit is set if the PVT Rising Edge max limit is violated.
7	LIMit FAIL This bit is set if the PVT Rising Edge mean limit is violated.
8	LIMit FAIL This bit is set if the PVT Falling Edge max limit is violated.
9	LIMit FAIL This bit is set if the PVT Falling Edge mean limit is violated.
10-14	These bits are not used
15	This bit is always 0

5.19.4 STATus:QUESTionable:SYNC Register

This register contains all information about sync and bursts not found, and about pre-measurement results exceeding or falling short of expected values. It can be read using the commands `STATus:QUESTionable:SYNC:CONDition?` and `STATus:QUESTionable:SYNC[:EVENT]?`.

Table 5-8: Meaning of the bits used in the STATus:QUESTionable:SYNC register

Bit No.	Meaning
0	BURSt not found This bit is set if an IQ measurement is performed and no bursts are detected
1	This bit is not used
2	No bursts of REQuired type This bit is set if an IQ measurement is performed and no bursts of the specified type are detected
3	GATE length too small This bit is set if gating is used in a measurement and the gate length is not set sufficiently large enough
4	BURSt count too small This bit is set if a PVT measurement is performed with gating active and there is not at least 1 burst within the gate lines
5	Auto level OVERload This bit is set if a signal overload is detected when an auto-level measurement is performed

Bit No.	Meaning
6	Auto level NoSiGnal This bit is set if no signal is detected by the auto-level measurement
7 - 14	These bits are not used.
15	This bit is always 0.

5.19.5 STATus:QUEStionable:ACPLimit Register

This register contains information about the observance of limits during adjacent power measurements. It can be read using the commands `STATus:QUEStionable:ACPLimit:CONDition` and `STATus:QUEStionable:ACPLimit[:EVENT]`.



No limit lines are displayed in screen A.

Table 5-9: Meaning of the bits used in the STATus:QUEStionable:ACPLimit register

Bit No.	Meaning
0 - 7	Not used
8	ADJ UPPer FAIL (Screen B) This bit is set if the limit is exceeded in the upper adjacent channel in screen B
9	ADJ LOWer FAIL (Screen B) This bit is set if the limit is exceeded in the lower adjacent channel in screen B.
10	ALT1 UPPer FAIL (Screen B) This bit is set if the limit is exceeded in the upper 1st alternate channel in screen B.
11	ALT1 LOWer FAIL (Screen B) This bit is set if the limit is exceeded in the lower 1st alternate channel in screen B.
12	ALT2 UPPer FAIL (Screen B) This bit is set if the limit is exceeded in the upper 2nd alternate channel in screen B.
13	ALT2 LOWer FAIL (Screen B) This bit is set if the limit is exceeded in the lower 2nd alternate channel in screen B.
14	Not used
15	This bit is always 0.

List of Commands

[SENSe:]BANDwidth:CHANnel:AUTO:TYPE.....	183
[SENSe:]BANDwidth[:RESolution]:FILTer.....	184
[SENSe:]BURSt:COUNT.....	185
[SENSe:]BURSt:COUNT:STATe.....	185
[SENSe:]DEMod:CESTimation.....	185
[SENSe:]DEMod:FFT:OFFSet.....	186
[SENSe:]DEMod:FILTer:CATalog?.....	186
[SENSe:]DEMod:FILTer:EFLength.....	186
[SENSe:]DEMod:FILTer:MODulation.....	187
[SENSe:]DEMod:FORMat:BANalyze.....	187
[SENSe:]DEMod:FORMat:BANalyze:BTYPe.....	187
[SENSe:]DEMod:FORMat:BANalyze:BTYPe:AUTO:TYPE.....	188
[SENSe:]DEMod:FORMat:BANalyze:DBYTes:EQual.....	189
[SENSe:]DEMod:FORMat:BANalyze:DBYTes:MAX.....	190
[SENSe:]DEMod:FORMat:BANalyze:DBYTes:MIN.....	190
[SENSe:]DEMod:FORMat:BANalyze:DURation:EQual.....	191
[SENSe:]DEMod:FORMat:BANalyze:DURation:MAX.....	191
[SENSe:]DEMod:FORMat:BANalyze:DURation:MIN.....	191
[SENSe:]DEMod:FORMat:BANalyze:SYMBols:EQual.....	192
[SENSe:]DEMod:FORMat:BANalyze:SYMBols:MAX.....	192
[SENSe:]DEMod:FORMat:BANalyze:SYMBols:MIN.....	193
[SENSe:]DEMod:FORMat:BTRate.....	194
[SENSe:]DEMod:FORMat:MCSIndex.....	194
[SENSe:]DEMod:FORMat:MCSIndex:MODE.....	194
[SENSe:]DEMod:FORMat:NSTSindex.....	195
[SENSe:]DEMod:FORMat:NSTSindex:MODE.....	195
[SENSe:]DEMod:FORMat:SIGSymbol.....	196
[SENSe:]DEMod:FORMat[:BContent]:AUTO.....	193
[SENSe:]DEMod:TXARea.....	196
[SENSe:]FREQuency:CENTer.....	197
[SENSe:]POWer:ACHannel:MODE.....	197
[SENSe:]POWer:SEM.....	198
[SENSe:]POWer:SEM:CLASs.....	198
[SENSe:]POWer:SEM:TRACe:REDUction.....	200
[SENSe:]SWAPiq.....	200
[SENSe:]SWEep:COUNT.....	200
[SENSe:]SWEep:EGATe.....	201
[SENSe:]SWEep:EGATe:HOLDoff:SAMPle.....	201
[SENSe:]SWEep:EGATe:HOLDoff[:TIME].....	201
[SENSe:]SWEep:EGATe:LENGth:SAMPle.....	202
[SENSe:]SWEep:EGATe:LENGth[:TIME].....	202
[SENSe:]SWEep:EGATe:LINK.....	202
[SENSe:]SWEep:EGATe:TYPE.....	203
[SENSe:]SWEep:TIME.....	203
[SENSe:]TRACking:LEVel.....	203
[SENSe:]TRACking:PHASe.....	203
[SENSe:]TRACking:PILots.....	204

[SENSe:]TRACking:TIME.....	204
ABORT.....	120
CALCulate<n>:BURSt[:IMMediate].....	120
CALCulate<n>:LIMit<1>:ACPower:ACHannel?.....	122
CALCulate<n>:LIMit<1>:ACPower:ALternate?.....	123
CALCulate<n>:LIMit<1>:BURSt:ALL.....	124
CALCulate<n>:LIMit<1>:BURSt:ALL:RESUlt?.....	124
CALCulate<n>:LIMit<1>:BURSt:EVM:ALL:MAXimum.....	126
CALCulate<n>:LIMit<1>:BURSt:EVM:ALL:MAXimum:RESUlt?.....	126
CALCulate<n>:LIMit<1>:BURSt:EVM:ALL[:AVERAge].....	125
CALCulate<n>:LIMit<1>:BURSt:EVM:ALL[:AVERAge]:RESUlt?.....	126
CALCulate<n>:LIMit<1>:BURSt:EVM:DATA:MAXimum.....	128
CALCulate<n>:LIMit<1>:BURSt:EVM:DATA:MAXimum:RESUlt?.....	128
CALCulate<n>:LIMit<1>:BURSt:EVM:DATA[:AVERAge].....	127
CALCulate<n>:LIMit<1>:BURSt:EVM:DATA[:AVERAge]:RESUlt?.....	127
CALCulate<n>:LIMit<1>:BURSt:EVM:MAXimum.....	128
CALCulate<n>:LIMit<1>:BURSt:EVM:MAXimum:RESUlt?.....	129
CALCulate<n>:LIMit<1>:BURSt:EVM:PILot:MAXimum.....	130
CALCulate<n>:LIMit<1>:BURSt:EVM:PILot:MAXimum:RESUlt?.....	130
CALCulate<n>:LIMit<1>:BURSt:EVM:PILot[:AVERAge].....	129
CALCulate<n>:LIMit<1>:BURSt:EVM:PILot[:AVERAge]:RESUlt?.....	129
CALCulate<n>:LIMit<1>:BURSt:EVM[:AVERAge].....	124
CALCulate<n>:LIMit<1>:BURSt:EVM[:AVERAge]:RESUlt?.....	125
CALCulate<n>:LIMit<1>:BURSt:FERRor:MAXimum.....	131
CALCulate<n>:LIMit<1>:BURSt:FERRor:MAXimum:RESUlt?.....	131
CALCulate<n>:LIMit<1>:BURSt:FERRor[:AVERAge].....	131
CALCulate<n>:LIMit<1>:BURSt:FERRor[:AVERAge]:RESUlt?.....	131
CALCulate<n>:LIMit<1>:BURSt:IQOffset:MAXimum.....	132
CALCulate<n>:LIMit<1>:BURSt:IQOffset:MAXimum:RESUlt?.....	133
CALCulate<n>:LIMit<1>:BURSt:IQOffset[:AVERAge].....	132
CALCulate<n>:LIMit<1>:BURSt:IQOffset[:AVERAge]:RESUlt?.....	132
CALCulate<n>:LIMit<1>:BURSt:SYMBOLerror:MAXimum.....	133
CALCulate<n>:LIMit<1>:BURSt:SYMBOLerror:MAXimum:RESUlt?.....	134
CALCulate<n>:LIMit<1>:BURSt:SYMBOLerror[:AVERAge].....	133
CALCulate<n>:LIMit<1>:BURSt:SYMBOLerror[:AVERAge]:RESUlt?.....	133
CALCulate<n>:LIMit<1>:BURSt:TFALI:MAXimum.....	134
CALCulate<n>:LIMit<1>:BURSt:TFALI:MAXimum:RESUlt?.....	135
CALCulate<n>:LIMit<1>:BURSt:TFALI[:AVERAge].....	134
CALCulate<n>:LIMit<1>:BURSt:TFALI[:AVERAge]:RESUlt?.....	134
CALCulate<n>:LIMit<1>:BURSt:TRISe:MAXimum.....	136
CALCulate<n>:LIMit<1>:BURSt:TRISe:MAXimum:RESUlt?.....	136
CALCulate<n>:LIMit<1>:BURSt:TRISe[:AVERAge].....	135
CALCulate<n>:LIMit<1>:BURSt:TRISe[:AVERAge]:RESUlt?.....	135
CALCulate<n>:LIMit<1>:CONTRol[:DATA].....	136
CALCulate<n>:LIMit<1>:SPECtrum:MASK:CHECK:X?.....	137
CALCulate<n>:LIMit<1>:SPECtrum:MASK:CHECK:Y?.....	138
CALCulate<n>:LIMit<1>:UPPER[:DATA].....	138
CALCulate<n>:LIMit<k>:ACPower:ACHannel:RESUlt.....	122
CALCulate<n>:LIMit<k>:ACPower:ALternate<channel>[:RELative].....	123
CALCulate<n>:LIMit<k>:FAIL?.....	137

CALCulate<n>:MARKer<1>:BSYMBOL.....	140
CALCulate<n>:MARKer<1>:CARRIER.....	140
CALCulate<n>:MARKer<1>:FUNCTION:POWER:RESULT:MAXHold?.....	144
CALCulate<n>:MARKer<1>:FUNCTION:POWER:RESULT[:CURRENT]?.....	144
CALCulate<n>:MARKer<1>:FUNCTION:ZOOM.....	145
CALCulate<n>:MARKer<1>:MAXimum.....	141
CALCulate<n>:MARKer<1>:MINimum.....	141
CALCulate<n>:MARKer<1>:SYMBOL.....	141
CALCulate<n>:MARKer<1>:TRACE.....	142
CALCulate<n>:MARKer<1>:X.....	142
CALCulate<n>:MARKer<1>:Y.....	143
CALCulate<n>:MARKer<m>:AOFF.....	139
CALCulate<n>:MARKer<m>[:STATE].....	139
CONFigure:BURSt:CONStellation:CARRIER:SElect.....	146
CONFigure:BURSt:CONStellation:CCARRIER[:IMMEDIATE].....	147
CONFigure:BURSt:CONStellation:CSYMBOL[:IMMEDIATE].....	147
CONFigure:BURSt:EVM:ECARRIER[:IMMEDIATE].....	147
CONFigure:BURSt:EVM:ESYMBOL[:IMMEDIATE].....	148
CONFigure:BURSt:PREAmble:SElect.....	148
CONFigure:BURSt:PREAmble[:IMMEDIATE].....	148
CONFigure:BURSt:PVT:AVERAge.....	149
CONFigure:BURSt:PVT:RPOWER.....	149
CONFigure:BURSt:PVT:SElect.....	149
CONFigure:BURSt:PVT[:IMMEDIATE].....	148
CONFigure:BURSt:SPECTrum:ACPR[:IMMEDIATE].....	150
CONFigure:BURSt:SPECTrum:FFT[:IMMEDIATE].....	150
CONFigure:BURSt:SPECTrum:FLATness:CSElect.....	151
CONFigure:BURSt:SPECTrum:FLATness:SElect.....	151
CONFigure:BURSt:SPECTrum:FLATness[:IMMEDIATE].....	151
CONFigure:BURSt:SPECTrum:MASK:SElect.....	152
CONFigure:BURSt:SPECTrum:MASK[:IMMEDIATE].....	152
CONFigure:BURSt:STATistics:BSTReam[:IMMEDIATE].....	152
CONFigure:BURSt:STATistics:CCDF[:IMMEDIATE].....	152
CONFigure:BURSt:STATistics:SFIELD[:IMMEDIATE].....	153
CONFigure:CHANnel.....	153
CONFigure:POWER:AUTO.....	153
CONFigure:POWER:AUTO:SWEep:TIME.....	154
CONFigure:POWER:EXPEcted:IQ.....	154
CONFigure:POWER:EXPEcted:RF.....	154
CONFigure:STANdard.....	154
CONFigure:WLAN:ANTMatrix:ADDReSS<RecPath>.....	155
CONFigure:WLAN:ANTMatrix:ANTenna<RecPath>.....	155
CONFigure:WLAN:ANTMatrix:STATe<RecPath>.....	156
CONFigure:WLAN:DUTConfig.....	156
CONFigure:WLAN:EXTension:AUTO:TYPE.....	156
CONFigure:WLAN:GTIME:AUTO.....	157
CONFigure:WLAN:GTIME:AUTO:TYPE.....	157
CONFigure:WLAN:GTIME:SElect.....	158
CONFigure:WLAN:MIMo:CAPTure.....	159
CONFigure:WLAN:MIMo[:CAPTure]:TYPE.....	159

CONFigure:WLAN:OSP:ADDRess.....	160
CONFigure:WLAN:OSP:MODule.....	160
CONFigure:WLAN:PAYload:LENGth:SRC.....	160
CONFigure:WLAN:PVERror:MRANge.....	161
CONFigure:WLAN:RSYnc:JOINed.....	161
CONFigure:WLAN:SMAPping:MODE.....	161
CONFigure:WLAN:SMAPping:NORMalise.....	162
CONFigure:WLAN:SMAPping:TX<1...4>.....	162
CONFigure:WLAN:SMAPping:TX<1...4>:STReam<1...4>.....	162
CONFigure:WLAN:SMAPping:TX<1...4>:TIMeshift.....	163
CONFigure:WLAN:STBC:AUTO:TYPE.....	163
DISPlay[:WINDow<n>]:SSElect.....	164
DISPlay[:WINDow<n>]:TABLe.....	165
DISPlay[:WINDow<n>]:TRACe<t>:Y[:SCALe]:AUTO.....	165
DISPlay[:WINDow<n>]:TRACe<t>:Y[:SCALe]:PDIVision.....	166
DISPlay[:WINDow<n>]:TRACe<t>:Y[:SCALe]:RLEVel:IQ.....	167
DISPlay[:WINDow<n>]:TRACe<t>:Y[:SCALe]:RLEVel:OFFSet.....	168
DISPlay[:WINDow<n>]:TRACe<t>:Y[:SCALe]:RLEVel?.....	166
DISPlay[:WINDow<n>]:TRACe<t>:Y[:SCALe]:RLEVel[:RF].....	167
DISPlay[:WINDow<n>][:SUBWindow<m>]:SIZE.....	164
FETCH:BURSt:ALL?.....	170
FETCH:BURSt:BERPilot:DATA:AVERAge?.....	170
FETCH:BURSt:BERPilot:DATA:MAXimum?.....	170
FETCH:BURSt:BERPilot:DATA:MINimum?.....	170
FETCH:BURSt:COUNt[:ALL]?.....	171
FETCH:BURSt:CRESt:MAXimum?.....	171
FETCH:BURSt:CRESt:MINimum?.....	171
FETCH:BURSt:CRESt[:AVERAge]?.....	171
FETCH:BURSt:EVM:[IEEE]:AVERAge?.....	171
FETCH:BURSt:EVM:[IEEE]:MAXimum?.....	171
FETCH:BURSt:EVM:[IEEE]:MINimum?.....	171
FETCH:BURSt:EVM:ALL:AVERAge?.....	171
FETCH:BURSt:EVM:ALL:MAXimum?.....	171
FETCH:BURSt:EVM:ALL:MINimum?.....	171
FETCH:BURSt:EVM:DATA:AVERAge?.....	172
FETCH:BURSt:EVM:DATA:MAXimum?.....	172
FETCH:BURSt:EVM:DATA:MINimum?.....	172
FETCH:BURSt:EVM:DIRect:AVERAge?.....	172
FETCH:BURSt:EVM:DIRect:MAXimum?.....	172
FETCH:BURSt:EVM:DIRect:MINimum?.....	172
FETCH:BURSt:EVM:PILot:AVERAge?.....	172
FETCH:BURSt:EVM:PILot:MAXimum?.....	172
FETCH:BURSt:EVM:PILot:MINimum?.....	172
FETCH:BURSt:FERRor:AVERAge?.....	173
FETCH:BURSt:FERRor:MAXimum?.....	173
FETCH:BURSt:FERRor:MINimum?.....	173
FETCH:BURSt:GIMBalance:AVERAge?.....	173
FETCH:BURSt:GIMBalance:MAXimum?.....	173
FETCH:BURSt:GIMBalance:MINimum?.....	173
FETCH:BURSt:IQOffset:AVERAge?.....	173

FETCh:BURSt:IQOffset:MAXimum?	173
FETCh:BURSt:IQOffset:MINimum?	173
FETCh:BURSt:PAYLoad?	173
FETCh:BURSt:PEAK?	174
FETCh:BURSt:PREamble?	174
FETCh:BURSt:QUADoffset:AVERage?	174
FETCh:BURSt:QUADoffset:MAXimum?	174
FETCh:BURSt:QUADoffset:MINimum?	174
FETCh:BURSt:RMS:MAXimum?	174
FETCh:BURSt:RMS:MINimum?	174
FETCh:BURSt:RMS[:AVERage]?	174
FETCh:BURSt:SYMBOLerror:AVERage?	175
FETCh:BURSt:SYMBOLerror:MAXimum?	175
FETCh:BURSt:SYMBOLerror:MINimum?	175
FETCh:BURSt:TFALI:AVERage?	175
FETCh:BURSt:TFALI:MAXimum?	175
FETCh:BURSt:TFALI:MINimum?	175
FETCh:BURSt:TRISe:AVERage?	175
FETCh:BURSt:TRISe:MAXimum?	175
FETCh:BURSt:TRISe:MINimum?	175
FETCh:SYMBOL:COUNT?	175
FORMat[:DATA]	176
INITiate<n>:CONTinuous	176
INITiate<n>[:IMMediate]	177
INPut:ATTenuation	177
INPut:DIQ:RANGe[:UPPer]	178
INPut:DIQ:SRATe	178
INPut:SElect	179
INSTRument:NSElect	179
INSTRument[:SElect]	179
MMEMory:LOAD:IQ:STATe	180
MMEMory:LOAD:SEM:STATe 1	180
MMEMory:STORe:IQ:STATe	180
STATus:OPERation:CONDition	205
STATus:OPERation[:EVENT]	205
STATus:QUESTionable:ACPLimit:CONDition	206
STATus:QUESTionable:ACPLimit:ENABLE	207
STATus:QUESTionable:ACPLimit:NTRansition	207
STATus:QUESTionable:ACPLimit:PTRansition	208
STATus:QUESTionable:ACPLimit[:EVENT]	206
STATus:QUESTionable:CONDition	205
STATus:QUESTionable:LIMit<Screen>:CONDition	206
STATus:QUESTionable:LIMit<Screen>:ENABLE	207
STATus:QUESTionable:LIMit<Screen>:NTRansition	207
STATus:QUESTionable:LIMit<Screen>:PTRansition	208
STATus:QUESTionable:LIMit<Screen>[:EVENT]	206
STATus:QUESTionable:SYNC:CONDition?	206
STATus:QUESTionable:SYNC:ENABLE?	207
STATus:QUESTionable:SYNC:NTRansition?	207
STATus:QUESTionable:SYNC:PTRansition?	208

STATus:QUEStionable:SYNC[:EVENT]?	206
STATus:QUEStionable[:EVENT]?	206
TRACe:IQ:DATA:MEMory ?	210
TRACe:IQ:SRATe	210
TRACe[:DATA]?	209
TRIGger[:SEQuence]:HOLDoff	217
TRIGger[:SEQuence]:LEVel:POWer	219
TRIGger[:SEQuence]:LEVel:POWer:AUTO	220
TRIGger[:SEQuence]:MODE	218
TRIGger<n>[:SEQuence]:IFPower:HOLDoff	217
TRIGger<n>[:SEQuence]:IFPower:HYSTeresis	218
TRIGger<n>[:SEQuence]:LEVel[:EXTernal]	218
UNIT:EVM	220
UNIT:GIMBalance	220
UNIT:PREAmble	221

Index

A

Amplitude menu	
K91/91n	64
Attenuation	
Manual	177

B

Baseband Digital	
K91	91
Burst EVM (Direct)	49

C

Chan Sel	
Softkey	82
Characters	
Special	118
Commands	
Description	117

D

demodulation settings	
K91/91n	64
DigIConf	
Softkey	115
Display	
maximized	164
split	164

E

Equalizer Filter	
Length	104
EVM	
IEEE 802.11b	48
K91	48
EX-IQ-BOX	114
DigIConf	115
Exporting	
I/Q data (remote)	180

F

Frequency menu	
K91/91n	64
Full Scale Level	
Digital I/Q Interface (remote control)	178
Digital IQ	92

G

General Settings dialog box	
K91/91n	64

I

I/Q data	
Export (remote control)	180
Import (remote control)	180
IEC/IEEE bus	
Command description	117

Importing	
I/Q data (remote)	180
Input sample rate	
Digital IQ	92
Input/Output menu	
WLAN	113

K

key	
INPUT/OUTPUT (WLAN)	113

L

Lines menu	
K91/K91n	113
Lower-case (commands)	118

M

Marker menu	
WLAN	111
Marker To menu	
K91/K91n	112
measurement	
WLAN TX (K91/91n)	50
measurement example	
basic (K91/91n)	13
Measurement menu	
K91/91n	63
menu	
Amplitude (K91/91n)	64
Frequency (K91/91n)	64
Lines (K91/91n)	113
Marker (WLAN)	111
Marker To (K91/91n)	112
Trace (K91/91n)	111
Trigger (K91/91n)	64
WLAN	62
WLAN (K91/91n)	63
Messages	
Signal Field	42
MIMO	12
Method	159
Sequential	160
Sequential using OSP	95
Signal path	159

N

Nsts	
PPDUs	106, 195

O

Online help	
Working with	8
OSP	
Address	160
Module	160
Setup	95

P

Peak EVM (IEEE)	48
Power	
Interval search	108
Power interval search	196
PPDU	
Nsts	106
Nsts (IEEE 802.11 ac)	106, 195
Power search	108, 196

R

R&S Support	
softkey	69, 114
Receive Filter	103
RX Settings	
softkey	114

S

Sample rate	
Digital I/Q Interface (remote control)	178
Digital IQ	92
SCPI	
Conformity information	117
SEM	
Configuration (K91)	82
Trace detector (remote control)	200
Signal Field	
Measurement	39
signal processing	
IEEE 802.11a (K91/91n)	21
IEEE 802.11b (K91/91n)	29
Signal Source	
Remote control	179
SISO	12
softkey	
ACP Rel/Abs (K91/91n)	80
ACP Rel/Abs (remote control, K91/91n)	144
Auto Level (K91/91n)	110
Average Length (K91/91n)	67
Bitstream (K91/91n)	83
Carrier Selection (K91/91n)	75
CCDF (K91/91n)	83
Constell vs Symbol/Carrier (K91/91n)	73
Cont Meas (remote control)	177
Continue Single Sweep (remote control)	177
Continuous Sweep (remote control)	177
Default All (K91/91n)	113
Default Current (K91/91n)	113
Display List/Graph (K91/91n)	64, 111
Edit ACLR Limit (remote control)	123
Error Frequency/Phase (K91/91n)	71
EVM Constell (K91/91n)	69
EVM vs Symbol/Carrier (K91/91n)	69
Export (remote control)	180
Full PPDU (K91/91n)	65
Gated Trigger (remote control)	201
Import (remote control)	180
Limit Chk On/Off (remote control)	122
Marker 1 (K91/91n)	112
Marker 1 (remote control, K91/91n)	140, 143
Marker 1 (remote control, K93)	141, 142
Marker 1 to 4 (remote control)	139
Marker Off (K91/91n)	112
Marker Zoom (remote control, K91/91n)	145

Marker Zoom (WLAN)	112
Meas Single/Cont (K91/91n)	110
Min (K91/91n)	112
Min (remote control, K93)	141
MKR -> Trace (K91/91n)	113
MKR -> Trace (remote control, K91/91n)	142
Peak (K91/91n)	112
Peak (remote control, K93)	141
PVT (K91/91n)	64
R&S Support	69, 114
Ramp Up/Down/Up & Down (K91/91n)	66
Ref Pow Max/Mean (K91/91n)	67
Refresh (K91/91n)	110
Rising & Falling (K91/91n)	65
Screen A/B (K91/91n)	111
Screen Full/Split (K91/91n)	111
Select 1 2 3 4 (remote control)	139
SEM Settings	81
Settings General/Demod (K91/91n)	64
Settings General/Demod (remote control, K91/91n)	210
Settings General/Demod (remote control, WLAN)	217, 218, 219, 220
Signal Field (K91/91n)	85, 86
Single Meas (remote control)	177
Single Sweep (remote control)	177
Spectrum (K91/91n)	76
Spectrum ACPR (K91/91n)	80
Spectrum ACPR (remote control, K91/91n)	144
Spectrum ETSI/IEEE (K91/91n)	78
Spectrum FFT (K91/91n)	79
Spectrum Flatness (K91/91n)	76
Spectrum Mask (K91/91n)	78
Statistics (K91/91n)	82
Trg/Gate Source (remote control)	218
Unzoom (K91/91n)	112
Unzoom (remote control, K91/91n)	145
Y-Axis/Div (K91/91n)	75

Softkey

ACP Rel/Abs (remote control, WLAN)	150
Auto Lvl (remote control, WLAN)	153
Average Length (remote control, WLAN)	149
Bitstream (remote control, WLAN)	152
Carrier Selection (remote control, WLAN)	146
CCDF (remote control, WLAN)	152
Center (remote control)	197
Constell vs Symbol/Carrier (remote control, WLAN)	147
Cont Meas (remote control)	176
Continuous Sweep (remote control)	176
DiglConf	115
Display List/Graph (remote control, WLAN)	165
Error Frequency/Phase (remote control, WLAN)	148
EVM vs Symbol/Carrier (remote control, WLAN)	147, 148
EX-IQ-BOX	114
Export	68
Full Burst (remote control, WLAN)	149
Gating Settings On/Off (K91/91n)	67
General Settings (remote control, WLAN)	153, 154
IF Power Retrigger Holdoff (remote control)	217
IF Power Retrigger Hysteresis (remote control)	218
Import	68
Mech Atten Manual (remote control)	177
PLCP Header (remote control, WLAN)	153
PVT (remote control, WLAN)	148
Ramp Up/Down/Up & Down (remote control, WLAN)	149
Ref Pow Max/Mean (remote control, WLAN)	149

RF Atten Manual (remote control)	177
Rising & Falling (remote control, WLAN)	149
Screen A/B (remote control, WLAN)	164
Settings General/Demod (remote control, WLAN)	166
Signal Field (remote control, WLAN)	153
Single Meas (remote control)	176
Single Sweep (remote control)	176
Spectrum ACPR (remote control, WLAN)	150
Spectrum FFT (remote control, WLAN)	150
Spectrum Flatness (remote control, WLAN)	151
Spectrum IEEE/ETSI (remote control, WLAN)	152
Spectrum Mask (remote control, WLAN)	152
Sweep Time (remote control)	203
Sweeptime Manual (remote control)	203
Trigger Holdoff	90
Trigger Hysteresis	91
Y-Axis/Div (remote control, WLAN)	165, 166
Softkeys	
Chan Sel	82
Special characters	118
SPLIT/MAXIMIZE	
Key	164
Status registers	
STATus:OPERation	224
STATus:QUESTionable	224
STATus:QUESTionable:ACPLimit	227
STATus:QUESTionable:LIMit	225
STATus:QUESTionable:SYNC	226
Status reporting system	221
Swap IQ	
remote control	200
Sweep menu	
K91/91n	110
T	
title bar	
K91/91n	61
Trace menu	
K91/K91n	111
Transmit Filter	103
Trigger	
Holdoff	90
Hysteresis	91
Synchronization	37
Trigger menu	
K91/91n	64
TX Settings	
EX-IQ-BOX	114
U	
Upper-case (commands)	118
W	
WLAN menu	62
K91/91n	63